

# TL50 Pro Tower Light



## Datasheet

### 50 mm Programmable Multicolor RGB Tower Light



- Rugged, cost-effective, and easy-to-install multi-segment tower lights
- Programmable using Banner's Pro Editor software and Pro Converter Cable
- Illuminated segments provide easy-to-see operator guidance and indication of equipment status
- Up to 7 segments available
- Available in black or light gray housing to match different machine styles
- Audible models available with standard, sealed, or omni-directional audible element
- Compact and beacon models are more intense in a smaller form factor compared to standard models
- 10 V dc to 30 V dc operation
- Bimodal inputs (PNP/NPN), depending on source wiring

## Models

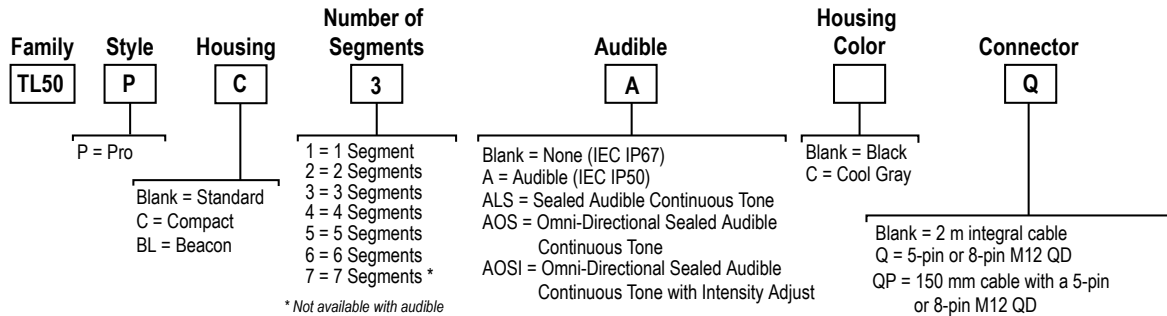

TL50 Pro models without audible have a 5-pin M12/Euro-style quick disconnect for one through four segments and have an 8-pin M12/Euro-style quick disconnect for five to seven segments. Models with an audible segment have a 5-pin M12/Euro-style quick disconnect for one through three segments and have an 8-pin M12/Euro-style quick disconnect for four through six segments.

## Configuration Instructions

### Pro Editor

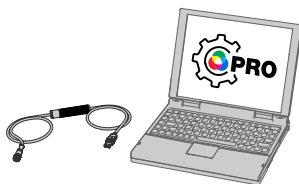

Use Banner's Pro Editor software and Pro Converter Cable to create custom configurations by selecting different colors, flash patterns, and animations.

For more information visit [www.bannerengineering.com/proeditor](http://www.bannerengineering.com/proeditor).



### Full Preview Connection (Recommended)

The full preview connection must be used for the TL50 Pro Tower Light and is optional, but recommended, for other Pro-series enabled devices.

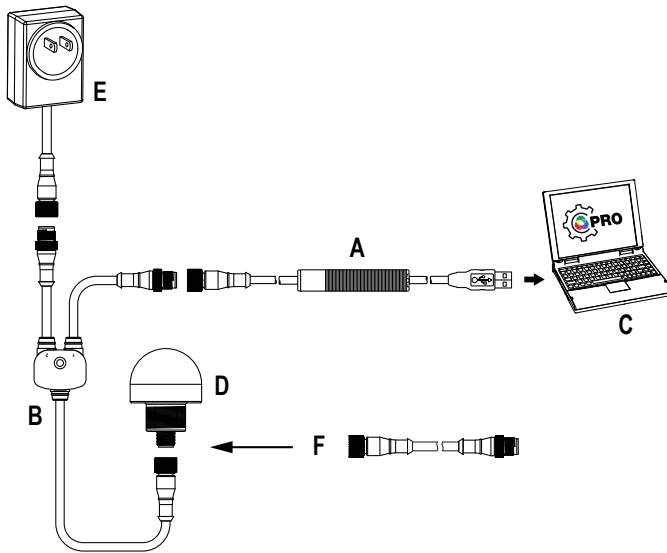

- A = Pro Converter Cable (MQDC-506-USB)
- B = Splitter (CSB-M1251FM1251M)
- C = PC running Pro Editor software
- D = Any Banner Pro Series-enabled device (K50 shown)
- E = Power Supply (PSW-24-1)
- F = 8-Pin to 5-Pin Double-Ended Cordset (MQDC-801-5M-PRO), required for 8-Pin models

### Default Segment Colors

Number of Segments	Colors (Bottom to Top)
1	Red
2	Green, Red
3	Green, Yellow, Red
4	Blue, Green, Yellow, Red
5	White, Blue, Green, Yellow, Red
6	Orange, White, Blue, Green, Yellow, Red
7	Magenta, Orange, White, Blue, Green, Yellow, Red

### Wiring Diagrams



**Note:** All models are bimodal and can be wired as PNP or NPN devices.

#### 5-pin/Wire Models

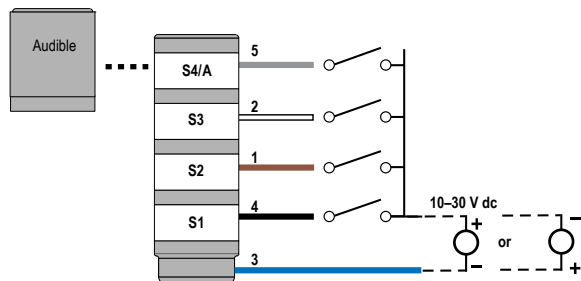

- S1 = Segment 1
- S2 = Segment 2
- S3 = Segment 3
- S4 = Segment 4
- A = Audible

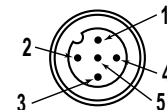

Pin	Color	Segment Mode	Advanced Mode
3	blue	Common	Common (PNP) or 10-30 V dc (NPN)
4	black	Segment 1	Reset Input
1	brown	Segment 2	10-30 V dc (PNP) or Common (NPN)
2	white	Segment 3	PWM, PFM, Counter, or Timer input
5	gray	Segment 4/Audible	N/A

**8-pin/Wire Models**

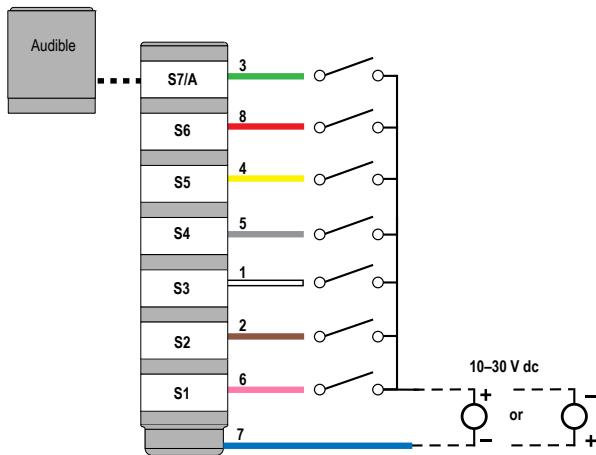

- S1 = Segment 1
- S2 = Segment 2
- S3 = Segment 3
- S4 = Segment 4
- S5 = Segment 5
- S6 = Segment 6
- S7 = Segment 7
- A = Audible

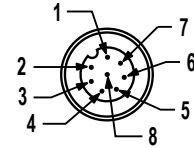

Pin	Color	Segment Mode	Advanced Mode
7	blue	Common	Common (PNP) or 10-30 V dc (NPN)
6	pink	Segment 1	Reset Input
2	brown	Segment 2	10-30 V dc (PNP) or Common (NPN)
1	white	Segment 3	PWM, PFM, Counter, or Timer input
5	gray	Segment 4	N/A
4	yellow	Segment 5	N/A
8	red	Segment 6	N/A
3	green	Segment 7/Audible	N/A

**Pro Editor Configuration for the TL50 Pro**

Banner's Pro Editor software offers an easy way to configure Pro Series-enabled touch and indicator devices, allowing users full control of device states. The easy-to-use configuration software provides a variety of tools and capabilities to solve a wide range of applications. Pro Editor includes a preview mode that allows users to verify device performance before writing a configuration to a device. Configure any Pro Series-enabled device using the free Pro Editor software, available for download at [www.bannerengineering.com/proeditor](http://www.bannerengineering.com/proeditor).

**Segment Mode**—Use Segment Mode to activate each segment and to control the input wire, color, animation, intensity, and speed.

In **Segment Mode**, enable the Action Input to switch between Segment Mode and Run Mode (all segments) animations depending on wiring. The combination of the Action Input and the Segment input controls all tower light segments at once.

Segment Mode Animation	Description
Off	Segment is off
Steady	Color 1 is on at defined intensity
Flash	Color 1 flashes at defined speed, color intensity, and pattern (normal, strobe, three pulse, SOS, or random)
Two Color Flash	Color 1 and Color 2 flash alternately at defined speed, color intensities, and pattern (normal, strobe, three pulse, SOS, or random)
50/50	Color 1 is displayed on 50% of the segment and Color 2 is displayed on the other 50% of the segment at the defined color intensities
50/50 Rotate	Color 1 is displayed on 50% of the segment and Color 2 is displayed on the other 50% of the segment while rotating at the defined speed, color intensities, and rotational direction
Chase	Color 1 is displayed as a single spot against the background of Color 2 while rotating at the defined speed, color intensities, and rotational direction
Intensity Sweep	Color 1 repeatedly increases and decreases intensity between 0% to 100% at defined speed and color intensity

**Run Mode**—Use the TL50 Pro's Run Mode to control the entire tower light and to control the input wire, color, animation, intensity, and speed. Run Mode with a larger assigned run number overrides the lower assigned run numbers.

Run or Action Mode Animation	Description
Off	All tower light segments are off
Steady	Color 1 is solid on for every tower light segment at defined intensity
Flash	Color 1 flashes on every tower light segment at defined speed, color intensity, and pattern (normal, strobe, three pulse, SOS, or random)
Two Color Flash	Color 1 and Color 2 flash alternately on every segment at defined speed, color intensities, and pattern (normal, strobe, three pulse, SOS, or random)

Run or Action Mode Animation	Description
50/50	Color 1 is displayed on 50% of every segment and Color 2 is displayed on the other 50% of every segment at the defined color intensities and segment shift
50/50 Rotate	Color 1 is displayed on 50% of every segment and Color 2 is displayed on the other 50% of every segment while rotating at the defined speed, color intensities, rotational direction, and segment shift
Chase	Color 1 is displayed as a single spot against the background of Color 2 while rotating at the defined speed, color intensities, rotational direction, and segment shift
Intensity Sweep	Color 1 repeatedly increases and decreases intensity between 0% to 100% on every segment at defined speed and color intensity
Scroll	Color 1 fills two segments and those segments move in one direction up or down against the background of Color 2 at the defined speed, color intensities, and rotational direction
Bounce	Color 1 fills a two segments and those segments move up and down between the top and bottom of the tower against the background of Color 2 at the defined speed, color intensities, and rotational direction
Color Spectrum	The tower light scrolls through the 14 predefined colors with a different color on each segment at the defined speed, Color 1 intensity, and rotational direction

**Advanced Mode**—Use Advanced Mode to set the value range, thresholds, colors, intensities, flash speeds, and animation types for PWM, PFM, Counter, and Timer control inputs.

Advanced Mode Parameters	Description
Control Type	PWM (Pulse Width Modulation): Apply a square wave signal to the PWM/PFM Input and vary the duty cycle from 0 to 100% to set value. The signal must use a constant frequency between 100 to 10,000 Hz.
	PFM (Pulse Frequency Modulation): Apply a square wave signal to the PWM/PFM Input and vary the frequency from 100 to 10,000 Hz to set the value. The signal must use a constant duty cycle from 10 to 90%.
	Counter: Apply a single pulse to the Counter Input to change the value by 1. Apply a single pulse to the Reset Input to set the value to the starting value, if enabled. The pulse signal must last a minimum of 16 ms; the value changes on the leading edge.
	Timer: Apply constant power to the tower to change the value by 1 every 1 second. Use a constant on or off signal on the Timer Run Input to start and pause the timer, respectively, if enabled. Apply a pulse to the Reset Input to set the value to the starting value, if enabled. The pulse signal must last a minimum of 16 ms; the value changes on the leading edge.
Subsegment Style	If the value is a partial percentage of a segment, select if segment will be on steady or analog dimmed to the partial percentage
Start From	Top: The value decreases from the maximum value Bottom: The value increases from the minimum value
Reset Input	Apply a pulse signal to the Reset Input to set the value to the starting value, if enabled. The pulse signal must last a minimum of 16 ms.
Threshold Dominance	Dominant: All segments display the active threshold color Non-Dominant: Segments display their defined threshold color
Threshold Type: Background	A defined color and intensity is displayed on segments that are not active
Threshold Type: Base	A defined animation state is displayed on segments that are not defined within a threshold
Threshold Type	≤: The animation state is displayed on the segments that are less than or equal to the defined threshold ≥: The animation state is displayed on the segments that are greater than or equal to the defined threshold Disabled: The threshold is disabled

Global Parameters and Advanced Settings	Description
Orientation	Standard: The tower base is down Upside Down: The tower base is up
Background Color	A defined color and intensity is displayed on segments that are not active
Animation Sync	On: Segment animations align when any input state changes Off: Segment animations will not be synchronized
Auto Restart	On: The counter and timer will reset to the starting value after reaching the end value Off: The counter and timer will stop at the ending value
Timer Run Input	Use a constant on or off signal on the Timer Run Input to start and to pause the timer, respectively, if enabled

Global Parameters and Advanced Settings	Description
PFM/PWM Filter Level	Smooths the input signal by varying the sample size Low: The sample size is short and changes to the input signal are more noticeable High: The sample size is long and changes to the input signal are less noticeable
Hysteresis	Determines the signal value change needed to transition between thresholds and to prevent chatter None: The value follows the input signal High: A large value change is needed to transition between thresholds

## Specifications

### Supply Voltage and Current

10 V dc to 30 V dc

Maximum current per LED segment:

220 mA at 10 V dc

150 mA at 12 V dc

75 mA at 24 V dc

60 mA at 30 V dc

Maximum current for Standard Audible Alarm: 25 mA

Maximum current for Omni-Directional Sealed Audible: 45 mA

Maximum current for Sealed Audible Alarm: 35 mA

### Supply Protection Circuitry

Protected against reverse polarity and transient voltages

### Input Rating

Leakage Current Immunity: 400 uA

Indicator On/Off Response Time: 250 ms (maximum)

PWM Duty Cycle Range: 0 to 100%

PFM Frequency Range: 100 to 10000 Hz

### Connections

5-pin or 8-pin integral M12/Euro-style quick disconnect; 2 m (6.5 ft) integral

PVC cable; or a 150 mm (5.9 inch) PVC cable with a 5-pin or 8-pin M12/

Euro-style quick disconnect, depending on model

Models with a quick disconnect require a mating cordset

### Construction

Bases and Covers: ABS

Light Segment: Polycarbonate

### Operating Conditions

**Non-Audible:** -40 °C to +50 °C (-40 °F to +122 °F)

**Standard and Audible Sealed:** -20 °C to +50 °C (-4 °F to +122 °F)

95% at +50 °C maximum relative humidity (non-condensing)

### Environmental Rating

NEMA/UL Type 13

**Non-Audible and Sealed Audible:** IEC IP67

**Standard Audible:** IEC IP50

### Vibration and Mechanical Shock

Vibration: 10 Hz to 55 Hz, 1.0 mm peak-to-peak amplitude per IEC 60068-2-6

Shock: 30G 11 ms duration, half sine wave per IEC 60068-2-27

### Certifications



### Audible Adjustment

**Standard Audible Alarm:** Unscrew the cover (up to 1.5 turns maximum) to adjust the audible intensity. (Do not exceed 1.5 turns or the cover may detach during operation.) For maximum intensity, rotate the center plug 180° counterclockwise to remove it.

**Sealed Audible Alarm and Omni-Directional Sealed Audible Alarm with Intensity Adjustment:** Rotate the front cover until the desired intensity is reached.

**Omni-Directional Sealed Audible Alarm:** No adjustment.

### Audible Alarm

**Standard Audible Alarm:** 2.7 kHz ± 500 Hz oscillation frequency; maximum intensity 92 dB at 1 m (3.3 ft) (typical)

**Sealed Audible Alarm:** 2.9 kHz ± 250 Hz oscillation frequency; maximum intensity 94 dB at 1 m (3.3 ft) (typical)

**Omni-Directional Sealed Audible Alarm:** 2.1 kHz ± 250 Hz oscillation frequency; maximum intensity 99 dB at 1 m (3.3 ft) (typical)

**Omni-Directional Sealed Audible Alarm with Intensity Adjustment:** 2.1 kHz ± 250 Hz oscillation frequency; maximum intensity 95 dB at 1 m (3.3 ft) (typical)

### Required Overcurrent Protection



**WARNING:** Electrical connections must be made by qualified personnel in accordance with local and national electrical codes and regulations.

Overcurrent protection is required to be provided by end product application per the supplied table.

Overcurrent protection may be provided with external fusing or via Current Limiting, Class 2 Power Supply.

Supply wiring leads < 24 AWG shall not be spliced.

For additional product support, go to [www.bannerengineering.com](http://www.bannerengineering.com).

Supply Wiring (AWG)	Required Overcurrent Protection (Amps)
20	5.0
22	3.0
24	2.0
26	1.0
28	0.8
30	0.5

Indicator Characteristics

Color	Dominant Wavelength (nm) or Color Temperature (CCT)	Color Coordinates <sup>1</sup>		Lumen Output Per Segment (Typical at 25 °C)		
		X	Y	Standard	Compact	Beacon
Red	620	0.689	0.309	7.2	6.3	9.8
Green	522	0.154	0.700	17.5	14.1	21.8
Yellow	576	0.477	0.493	23.8	18.9	29.2
Blue	466	0.140	0.054	3.4	2.5	4.1
Magenta	–	0.379	0.172	10.4	8.3	12.6
Cyan	493	0.170	0.340	19.2	14.9	22.9
White	5700 K	0.328	0.337	24.8	19.5	29.9
Amber	589	0.556	0.420	15.3	12.3	19.2
Rose	–	0.515	0.220	8.2	6.7	10.1
Lime Green	562	0.388	0.561	21.2	16.8	25.9
Orange	599	0.616	0.370	11.3	9.3	14.5
Sky Blue	486	0.155	0.247	20.1	15.6	24.0
Violet	–	0.217	0.089	6.6	5.1	8.0
Spring Green	508	0.177	0.536	18.2	14.2	21.9

Dimensions

All measurements are listed in millimeters [inches], unless noted otherwise.

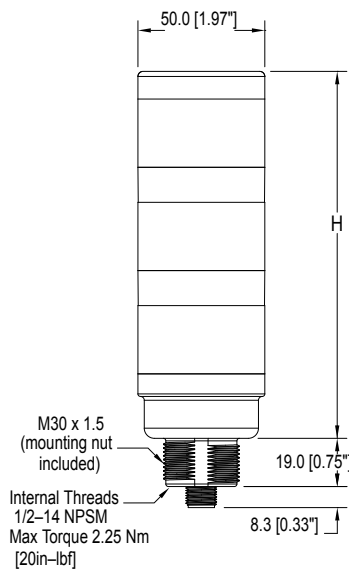

Figure 1. Standard Model Dimensions

Table 1: Standard Models

# of Segments	Non-Audible	Standard Audible	Sealed Audible	Omni-Directional Sealed Audible
1	61.2 (2.4)	92 (3.6)	115.1 (4.5)	129.1 (5.1)
2	101.9 (4)	132.7 (5.2)	155.8 (6.1)	169 (6.7)
3	142.6 (5.6)	173.4 (6.8)	196.5 (7.7)	210.5 (8.3)
4	183.3 (7.2)	214.1 (8.4)	237.2 (9.3)	251.2 (9.9)
5	224 (8.8)	254.8 (10)	277.9 (10.9)	291.9 (11.5)
6	264.7 (10.4)	295.5 (11.6)	318.6 (12.5)	332.6 (13.1)
7	305.4 (12)	336.2 (13.2)	359.3 (14.1)	373.3 (14.7)

<sup>1</sup> Refer to CIE 1931 chromaticity diagram or color chart to show equivalent color with indicated color coordinates

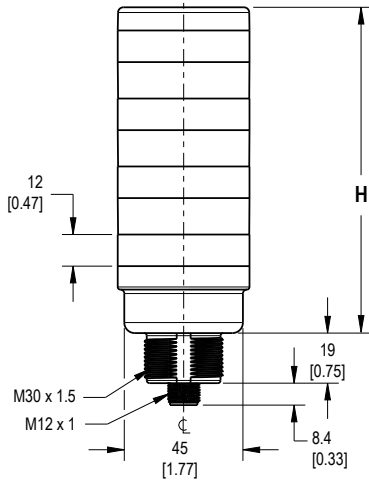

Figure 2. Compact and Beacon Model Dimensions

Table 2: Compact and Beacon Models

# of Segments	Non-Audible	Standard Audible	Sealed Audible	Omni-Directional Sealed Audible
1	46.2 (1.9)	77.1 (3.1)	110.2 (4)	114.2 (4.5)
2	72 (2.9)	102.9 (4.1)	126 (5)	140 (5.5)
3	97.8 (123.6)	128.7 (5.1)	151.8 (6)	165.8 (6.5)
4	123.6 (4.9)	154.5 (6.1)	177.6 (7)	191.6 (7.5)
5	149.4 (5.9)	180.3 (7.1)	203.4 (8)	217.4 (8.5)
6	175.2 (6.9)	206.1 (8.1)	229.2 (9)	243.2 (9.5)
7	201 (7.9)	231.9 (9.1)	255 (10)	269 (10.5)

## Accessories

### Pro Editor Hardware

#### MQDC-506-USB

- Pro Converter Cable
- 1.83 m (6 ft) M12/Euro-style quick disconnect to Device and USB to PC
- Required for connection to Pro Editor

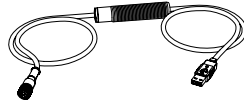

#### CSB-M1251FM1251M

- 5-pin parallel Y splitter (Male-Male-Female)
- For full Pro Editor preview capability
- Requires external power supply, sold separately

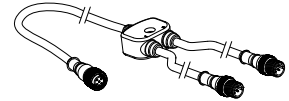

#### PSW-24-1

- 24 V dc, 1 A power supply
- 2 m (6.5 ft) PVC cable with M12/Euro-style quick disconnect
- Provides external power with splitter cable, sold separately



#### ACC-PRO-CABLE5

- Mating accessory for cabled and terminal models
- 150 mm (6 inch) PVC cable with M12/Euro-style quick disconnect
- Lever wire nuts included (qty 5)
- Required to connect cabled models to Pro Converter Cable, sold separately

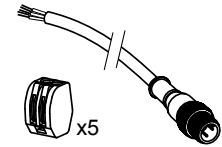

#### MQDC-801-5M-PRO

- 8-pin to 5-pin double-ended cordset
- 0.31 m (1 ft) PVC cable with M12/Euro-style quick disconnects
- Required to connect 8-pin Pro Series-enabled devices to Pro Converter Cable (MQDC-506-USB), sold separately



## Cordsets

5-Pin Threaded M12/Euro-Style Cordsets—Single Ended				
Model	Length	Style	Dimensions	Pinout (Female)
MQDC1-501.5	0.50 m (1.5 ft)	Straight		<p>1 = Brown 2 = White 3 = Blue 4 = Black 5 = Gray</p>
MQDC1-506	1.83 m (6 ft)			
MQDC1-515	4.57 m (15 ft)			
MQDC1-530	9.14 m (30 ft)			
MQDC1-506RA	1.83 m (6 ft)	Right-Angle		<p>1 = Brown 2 = White 3 = Blue 4 = Black 5 = Gray</p>
MQDC1-515RA	4.57 m (15 ft)			
MQDC1-530RA	9.14 m (30 ft)			

8-Pin Threaded M12/Euro-Style Cordsets with Open-Shield				
Model	Length	Style	Dimensions	Pinout (Female)
MQDC2S-806	1.83 m (6 ft)	Straight		<p>1 = White 2 = Brown 3 = Green 4 = Yellow 5 = Gray 6 = Pink 7 = Blue 8 = Red</p>
MQDC2S-815	4.57 m (15 ft)			
MQDC2S-830	9.14 m (30 ft)			
MQDC2S-850	15.2 m (50 ft)			
MQDC2S-806RA	1.83 m (6 ft)	Right-Angle		<p>1 = White 2 = Brown 3 = Green 4 = Yellow 5 = Gray 6 = Pink 7 = Blue 8 = Red</p>
MQDC2S-815RA	4.57 m (15 ft)			
MQDC2S-830RA	9.14 m (30 ft)			
MQDC2S-850RA	15.2 m (50 ft)			

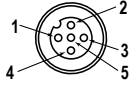
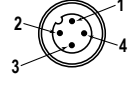
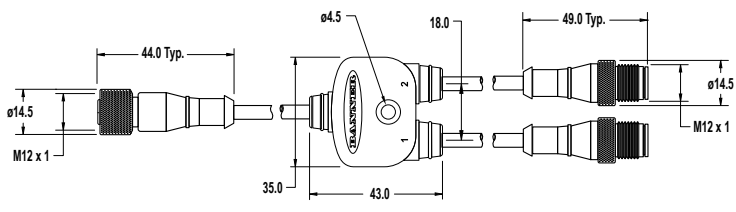

## Splitter Cables for Use with IO-Blocks

5-Pin Threaded M12/Euro-Style to 4-Pin Threaded M12/Euro Style Combiner Cordset with Flat Junction																					
Model	Branches (Male)	Trunk (Female)	Pinout																		
CSF-M12F51M12M41	4-pin Euro Quick Disconnect, 2 x 0.31 m	5-pin Euro Quick Disconnect, 0.31 m	<p>Female</p>  <p>Male</p>  <table border="1"> <thead> <tr> <th>Trunk</th> <th>Branch 1</th> <th>Branch 2</th> </tr> </thead> <tbody> <tr> <td>1 = Brown</td> <td>1 = NC</td> <td>1 = NC</td> </tr> <tr> <td>2 = White</td> <td>2 = Brown</td> <td>2 = Gray</td> </tr> <tr> <td>3 = Blue</td> <td>3 = Blue</td> <td>3 = Blue</td> </tr> <tr> <td>4 = Black</td> <td>4 = Black</td> <td>4 = White</td> </tr> <tr> <td>5 = Gray</td> <td></td> <td></td> </tr> </tbody> </table>	Trunk	Branch 1	Branch 2	1 = Brown	1 = NC	1 = NC	2 = White	2 = Brown	2 = Gray	3 = Blue	3 = Blue	3 = Blue	4 = Black	4 = Black	4 = White	5 = Gray		
Trunk	Branch 1	Branch 2																			
1 = Brown	1 = NC	1 = NC																			
2 = White	2 = Brown	2 = Gray																			
3 = Blue	3 = Blue	3 = Blue																			
4 = Black	4 = Black	4 = White																			
5 = Gray																					
																					

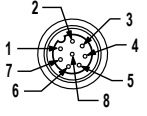
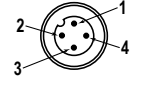
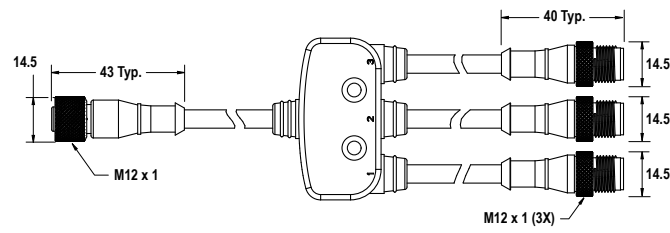
8-Pin Threaded M12/Euro-Style to 4-Pin Threaded M12/Euro Style Combiner Cordset with Flat Junction																																							
Model	Branches (Male)	Trunk (Female)	Pinout																																				
CSF3A-M12F81M12M41	4-pin Euro Quick Disconnect, 3 x 0.31 m	8-pin Euro Quick Disconnect, 0.31 m	<p>Female</p>  <p>Male</p>  <table border="1"> <thead> <tr> <th>Trunk</th> <th>Branch 1</th> <th>Branch 2</th> <th>Branch 3</th> </tr> </thead> <tbody> <tr> <td>1 = White</td> <td>1 = NC</td> <td>1 = NC</td> <td>1 = NC</td> </tr> <tr> <td>2 = Brown</td> <td>2 = Brown</td> <td>2 = Gray</td> <td>2 = Red</td> </tr> <tr> <td>3 = Green</td> <td>3 = Blue</td> <td>3 = Blue</td> <td>3 = Blue</td> </tr> <tr> <td>4 = Yellow</td> <td>4 = Pink</td> <td>4 = White</td> <td>4 = Yellow</td> </tr> <tr> <td>5 = Gray</td> <td></td> <td></td> <td></td> </tr> <tr> <td>6 = Pink</td> <td></td> <td></td> <td></td> </tr> <tr> <td>7 = Blue</td> <td></td> <td></td> <td></td> </tr> <tr> <td>8 = Red</td> <td></td> <td></td> <td></td> </tr> </tbody> </table>	Trunk	Branch 1	Branch 2	Branch 3	1 = White	1 = NC	1 = NC	1 = NC	2 = Brown	2 = Brown	2 = Gray	2 = Red	3 = Green	3 = Blue	3 = Blue	3 = Blue	4 = Yellow	4 = Pink	4 = White	4 = Yellow	5 = Gray				6 = Pink				7 = Blue				8 = Red			
Trunk	Branch 1	Branch 2	Branch 3																																				
1 = White	1 = NC	1 = NC	1 = NC																																				
2 = Brown	2 = Brown	2 = Gray	2 = Red																																				
3 = Green	3 = Blue	3 = Blue	3 = Blue																																				
4 = Yellow	4 = Pink	4 = White	4 = Yellow																																				
5 = Gray																																							
6 = Pink																																							
7 = Blue																																							
8 = Red																																							
																																							

## Mounting Brackets

All measurements are listed in millimeters [inches], unless noted otherwise.

### SMB30A

- Right-angle bracket with curved slot for versatile orientation
- Clearance for M6 (¼ in) hardware
- Mounting hole for 30 mm sensor
- 12-ga. stainless steel

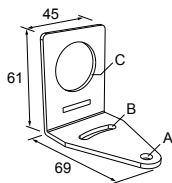

**Hole center spacing:** A to B=40

**Hole size:** A=ø 6.3, B= 27.1 x 6.3, C=ø 30.5

### SMB30FA

- Swivel bracket with tilt and pan movement for precise adjustment
- Mounting hole for 30 mm sensor
- 12-ga. 304 stainless steel
- Easy sensor mounting to extrude rail T-slot
- Metric and inch size bolt available

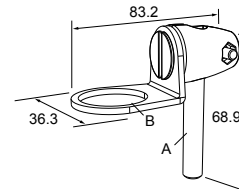

**Bolt thread:** SMB30FA, A= 3/8 - 16 x 2 in; SMB30FAM10, A= M10 - 1.5 x 50

**Hole size:** B= ø 30.1

### SMB30MM

- 12-ga. stainless steel bracket with curved mounting slots for versatile orientation
- Clearance for M6 (¼ in) hardware
- Mounting hole for 30 mm sensor

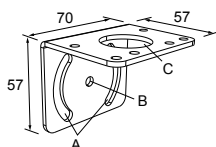

**Hole center spacing:** A = 51, A to B = 25.4

**Hole size:** A = 42.6 x 7, B = ø 6.4, C = ø 30.1

### SMBAMS30P

- Flat SMBAMS series bracket
- 30 mm hole for mounting sensors
- Articulation slots for 90°+ rotation
- 12-ga. 300 series stainless steel

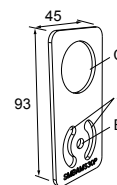

**Hole center spacing:** A=26.0, A to B=13.0

**Hole size:** A=26.8 x 7.0, B=ø 6.5, C=ø 31.0

### SMBAMS30RA

- Right-angle SMBAMS series bracket
- 30 mm hole for mounting sensors
- Articulation slots for 90°+ rotation
- 12-ga. (2.6 mm) cold-rolled steel

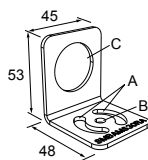

**Hole center spacing:** A=26.0, A to B=13.0

**Hole size:** A=26.8 x 7.0, B=ø 6.5, C=ø 31.0

### SMB30SC

- Swivel bracket with 30 mm mounting hole for sensor
- Black reinforced thermoplastic polyester
- Stainless steel mounting and swivel locking hardware included

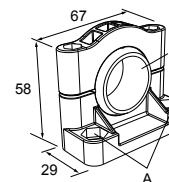

**Hole center spacing:** A=ø 50.8

**Hole size:** A=ø 7.0, B=ø 30.0

### LMBE12RA35

- Direct mounting of stand-off pipe, with common bracket type
- Zinc-plated steel
- 1/2-14 NPSM nut
- Mounting distance from the wall to the center of the 1/2-14 NPSM nut is 35 mm

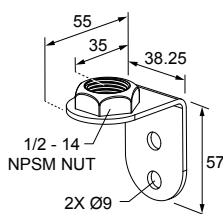

Hole center spacing: 20.0

### LMBE12RA45

- Direct mounting of stand-off pipe, with common bracket type
- Zinc-plated steel
- 1/2-14 NPSM nut
- Mounting distance from the wall to the center of the 1/2-14 NPSM nut is 45 mm

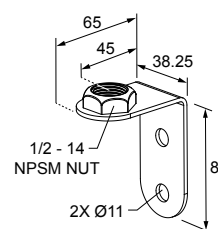



Hole center spacing: 35.0

## LMB Sealed Right-Angle Bracket

Model	Description	Construction	
LMB30RA	<b>Direct-Mount Models:</b> Bracket kit with base, 30 mm adapter, set screw, fasteners, O-rings, and gaskets.	Black polycarbonate	
LMB30RAC		Gray polycarbonate	
LMBE12RA	<b>Pipe-Mount Models:</b> Bracket kit with base, ½-14 pipe adapter, set screw, fasteners, O-rings, and gaskets. For use with stand-off pipe (listed and sold separately).	Black polycarbonate	
LMBE12RAC		Gray polycarbonate	

## Elevated Mount System

Model			Features	Components
SA-M30TE12 - Black Acetal			<ul style="list-style-type: none"> <li>Streamlined black acetal or white UHMW stand-off pipe adapter/cover</li> <li>Connects between 30 mm light base and ½ in. NPSM/DN15 pipe</li> <li>Mounting hardware included</li> </ul>	
SA-M30TE12C - White UHMW				
Polished 304 Stainless Steel	Black Anodized Aluminum	Clear Anodized Aluminum	<ul style="list-style-type: none"> <li>Elevated-use stand-off pipe (½ in. NPSM/DN15)</li> <li>Polished 304 stainless steel, black anodized aluminum, or clear anodized aluminum surface</li> <li>½ in. NPT thread at both ends</li> <li>Compatible with most industrial environments</li> </ul>	
SOP-E12-150SS 150 mm (6 in) long	SOP-E12-150A 150 mm (6 in) long	SOP-E12-150AC 150 mm (6 in) long		
SOP-E12-300SS 300 mm (12 in) long	SOP-E12-300A 300 mm (12 in) long	SOP-E12-300AC 300 mm (12 in) long		
SOP-E12-900SS 900 mm (36 in) long	SOP-E12-900A 900 mm (36 in) long	SOP-E12-900AC 900 mm (36 in) long		
SA-E12M30 - Black Acetal			<ul style="list-style-type: none"> <li>Streamlined black acetal or white UHMW mounting base adapter/cover</li> <li>Connects between ½ in. NPSM/DN15 pipe and 30 mm (1-3/16 in) drilled hole</li> <li>Mounting hardware included</li> </ul>	
SA-E12M30C - White UHMW				

## Pipe Mounting Flange

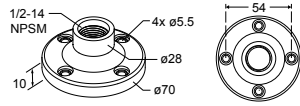
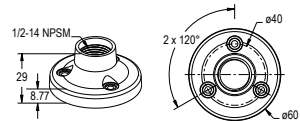
Pipe Mounting Flange			
Model	Features	Construction	
SA-F12	<ul style="list-style-type: none"> <li>Elevated-use stand-off pipes (½ in, NPSM/DN15)</li> <li>M5 mounting hardware and nitrile gasket included</li> </ul>	Die-cast zinc base with black paint	
SA-F12-3	<ul style="list-style-type: none"> <li>Elevated-use stand-off pipes (½ in, NPSM/DN15)</li> <li>M4 mounting hardware and nitrile blend gasket included</li> </ul>	Black Polycarbonate	

## Foldable Mounting Brackets

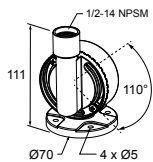
Foldable Mounting Brackets			
Model	Features	Construction	
SA-FFB12	<ul style="list-style-type: none"> <li>For use with 1/2 inch stand-off pipes</li> <li>Stainless steel hardware</li> </ul>	Black polycarbonate	
SA-FFB12C		Gray polycarbonate	

## Banner Engineering Corp. Limited Warranty

---

Banner Engineering Corp. warrants its products to be free from defects in material and workmanship for one year following the date of shipment. Banner Engineering Corp. will repair or replace, free of charge, any product of its manufacture which, at the time it is returned to the factory, is found to have been defective during the warranty period. This warranty does not cover damage or liability for misuse, abuse, or the improper application or installation of the Banner product.

**THIS LIMITED WARRANTY IS EXCLUSIVE AND IN LIEU OF ALL OTHER WARRANTIES WHETHER EXPRESS OR IMPLIED (INCLUDING, WITHOUT LIMITATION, ANY WARRANTY OF MERCHANTABILITY OR FITNESS FOR A PARTICULAR PURPOSE), AND WHETHER ARISING UNDER COURSE OF PERFORMANCE, COURSE OF DEALING OR TRADE USAGE.**

This Warranty is exclusive and limited to repair or, at the discretion of Banner Engineering Corp., replacement. **IN NO EVENT SHALL BANNER ENGINEERING CORP. BE LIABLE TO BUYER OR ANY OTHER PERSON OR ENTITY FOR ANY EXTRA COSTS, EXPENSES, LOSSES, LOSS OF PROFITS, OR ANY INCIDENTAL, CONSEQUENTIAL OR SPECIAL DAMAGES RESULTING FROM ANY PRODUCT DEFECT OR FROM THE USE OR INABILITY TO USE THE PRODUCT, WHETHER ARISING IN CONTRACT OR WARRANTY, STATUTE, TORT, STRICT LIABILITY, NEGLIGENCE, OR OTHERWISE.**

Banner Engineering Corp. reserves the right to change, modify or improve the design of the product without assuming any obligations or liabilities relating to any product previously manufactured by Banner Engineering Corp. Any misuse, abuse, or improper application or installation of this product or use of the product for personal protection applications when the product is identified as not intended for such purposes will void the product warranty. Any modifications to this product without prior express approval by Banner Engineering Corp will void the product warranties. All specifications published in this document are subject to change; Banner reserves the right to modify product specifications or update documentation at any time. Specifications and product information in English supersede that which is provided in any other language. For the most recent version of any documentation, refer to: [www.bannerengineering.com](http://www.bannerengineering.com).

For patent information, see [www.bannerengineering.com/patents](http://www.bannerengineering.com/patents).

## FCC Part 15 and CAN ICES-3 (B)/NMB-3(B)

This device complies with part 15 of the FCC Rules and CAN ICES-3 (B)/NMB-3(B). Operation is subject to the following two conditions:

1. This device may not cause harmful interference, and
2. This device must accept any interference received, including interference that may cause undesired operation.

This equipment has been tested and found to comply with the limits for a Class B digital device, pursuant to part 15 of the FCC Rules and CAN ICES-3 (B)/NMB-3(B). These limits are designed to provide reasonable protection against harmful interference in a residential installation. This equipment generates, uses and can radiate radio frequency energy and, if not installed and used in accordance with the instructions, may cause harmful interference to radio communications. However, there is no guarantee that interference will not occur in a particular installation. If this equipment does cause harmful interference to radio or television reception, which can be determined by turning the equipment off and on, the user is encouraged to try to correct the interference by one or more of the following measures:

- Reorient or relocate the receiving antenna.
- Increase the separation between the equipment and receiver.
- Connect the equipment into an outlet on a circuit different from that to which the receiver is connected.
- Consult the manufacturer.



more sensors, more solutions