

**Personnel safety, light screen
emitter/receiver pair
SLPP25-550P88**

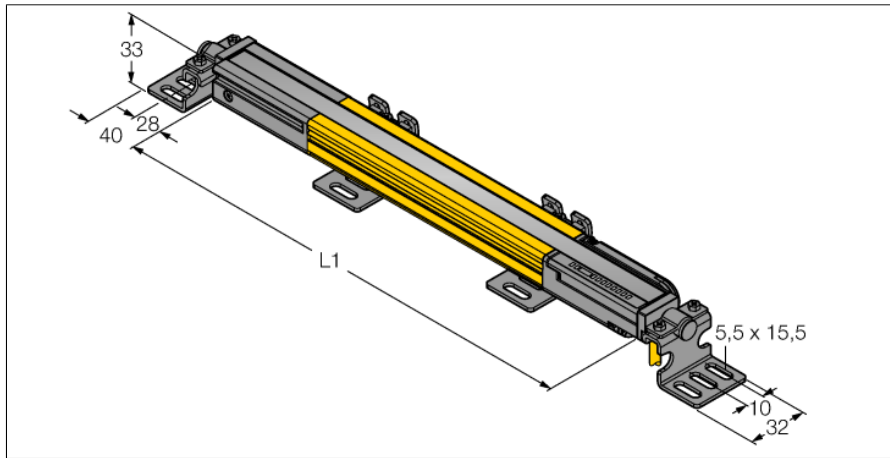

- Personnel safety Cat 4, PL e acc. to EN ISO 13849-1:2008
- Type 4 according to IEC 61496-1,-2
- SIL 3 to IEC 61508
- Cable with male end M12 x 1, 8-pin, 300 mm
- Protection class IP65
- Flat housing without blind zone
- Adjustment via DIP switch
- Resolution can be reduced
- Blanking function
- Operating voltage: 24 VDC ± 15 %
- Resolution 25 mm
- Scan field 550 mm (L1)

| | |
|--------------------------------|------------------------------------|
| Type code | SLPP25-550P88 |
| Ident no. | 3083738 |
| Operating mode | light screen |
| Light type | IR |
| Wavelength | 850 nm |
| Optical resolution | 25 mm |
| Range | 0...7000 mm |
| Detection zone height | 550 mm |
| Ambient temperature | 0...+55 °C |
| Operating voltage | 20...28VDC |
| Residual ripple | < 10 % U _s |
| No-load current I ₀ | ≤ 275 mA |
| Short-circuit protection | yes |
| Reverse polarity protection | yes |
| Output function | 2x NC, 2 x PNP |
| Response time | < 11 ms |
| Design | rectangular, EZ-Screen LP |
| Dimensions | 26 x 28 x 549 mm |
| Housing material | metal, AL, yellow |
| Lens | plastic, acrylic |
| Connection | cable with connector, PVC, M12 x 1 |
| Cable length | 300 m |
| Protection class | IP65 |
| Power-on indication | LED green |
| Switching state | 2-color LED red |

Wiring diagram

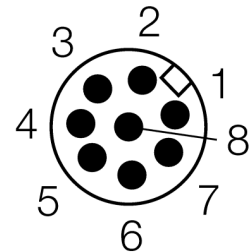
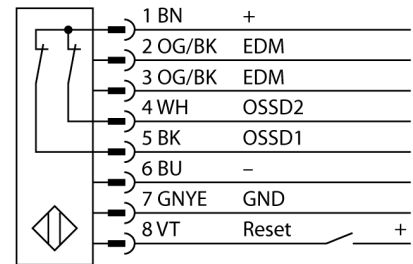

Functional principle

The high-resolution safety light curtain is emitter and receiver in one without blind zone. As the system is synchronized optically, wiring between emitter and receiver is redundant. The safety switching outputs of the receiver are directly connected to a load relay (e.g. IM-TA9A) and trigger an immediate stop of the dangerous machine cycle. The switching device with 2-channel monitoring, diverse redundant designed and mutual processor control, complies with the personnel safety category PLe acc. to ISO 13849-1.

**Personnel safety, light screen
emitter/receiver pair
SLPP25-550P88**

TURCK

Industrial
Automation

Accessories

| Type code | Ident no. | Description | Dimension drawing |
|------------|-----------|--|-------------------|
| LPA-MBK-11 | 3082841 | Mounting bracket, retainer for closure caps, 14-ga. steel, galvanized, black, 360 ° sensor rotation, incl.2 pcs. with screw set | |
| LPA-MBK-12 | 3082842 | Mounting bracket, side mounting, 14-ga. steel, galvanized, black, +10°/-30° sensor rotation, incl.1 pcs. with screw set | |
| LPA-MBK-20 | 3082853 | Mounting bracket, wall mounting, 12-ga. steel, galvanized, black, in combination with LPA-MBK-11/ -12/ -13, incl. 1 pcs. and screw set | |
| LPA-MBK-22 | 3082844 | Mounting bracket, wall mounting, 14-ga. steel, galvanized, black, in combination with LPA-MBK-11, incl. 2 pcs. and screw set | |

Wiring accessories

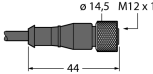
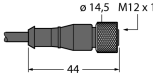
| Type code | Ident no. | Description | Dimension drawing |
|-------------|-----------|---|---|
| DEE2R-81D | 3072205 | Connection cable, PVC, yellow, length: 0.31 m, female M12 x 1 - male M12, 8-pin | |
| DEE2R-83D | 3072206 | Connection cable, PVC, yellow, length: 0.91 m, female M12 x 1 - male M12, 8-pin | |
| DEE2R-88D | 3072635 | Connection cable, PVC, yellow, length: 2.44 m, female M12 x 1 - male M12, 8-pin | |
| DEE2R-815D | 3072207 | Connection cable, PVC, yellow, length: 4.57 m, female M12 x 1 - male M12, 8-pin | |
| DEE2R-825D | 3072208 | Connection cable, PVC, yellow, length: 7.62 m, female M12 x 1 - male M12, 8-pin | |
| DEE2R-850D | 3072209 | Connection cable, PVC, yellow, length: 15.2 m, female M12 x 1 - male M12, 8-pin | |
| DEE2R-875D | 3072210 | Connection cable, PVC, yellow, length: 22.9 m, female M12 x 1 - male M12, 8-pin | |
| DEE2R-8100D | 3072211 | Connection cable, PVC, yellow, length: 30.5 m, female M12 x 1 - male M12, 8-pin | |
| QDE-815D | 3070883 | Connection cable, PVC, yellow, length: 4.57 m, female M12 x 1, 8-pin |  |
| QDE-825D | 3070884 | Connection cable, PVC, yellow, length: 7.62 m, female M12 x 1, 8-pin |  |

**Personnel safety, light screen
emitter/receiver pair
SLPP25-550P88**

TURCK

Industrial
Automation

Wiring accessories

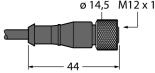
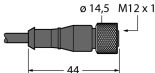
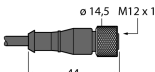
| Type code | Ident no. | Description | Dimension drawing |
|-----------------|-----------|--|---|
| QDE-850D | 3070885 | Connection cable, PVC, yellow, length: 15.3 m, female M12 x 1, 8-pin |  |
| QDE-875D | 3071466 | Connection cable, PVC, yellow, length: 22.9 m, female M12 x 1, 8-pin |  |
| QDE-8100D | 3071467 | Connection cable, PVC, yellow, length: 30.5 m, female M12 x 1, 8-pin |  |
| CSB-M1280M1280 | 3075375 | Y-piece, PVC, yellow, with male M12 x 1, 8-pin on 2 x 0.3 m cable, PVC, yellow, with female M12 x 1, 8-pin | |
| CSB-M1281M1281 | 3073252 | Y-piece, PVC, yellow, length: 0.3 m with male, M12 x 1, 8-pin on 2 x 0.3 m cable, PVC, yellow, with female, M12 x 1, 8-pin | |
| CSB-M1288M1281 | 3073253 | Y-piece, PVC, yellow, length: 2.5 m with male, M12 x 1, 8-pin on 2 x 0.3 m cable, PVC, yellow, with female, M12 x 1, 8-pin | |
| CSB-M12815M1281 | 3073254 | Y-piece, PVC, yellow, length: 4.6 m with male, M12 x 1, 8-pin on 2 x 0.3 m cable, PVC, yellow, with female, M12 x 1, 8-pin | |
| CSB-M12825M1281 | 3073255 | Y-piece, PVC, yellow, length: 7.6 m with male, M12 x 1, 8-pin on 2 x 0.3 m cable, PVC, yellow, with female, M12 x 1, 8-pin | |