



Technical catalogue SMISLINE Electrical protective devices in a system

SMISLINE – The original Shaping the future

SMISLINE protection devices are simply snapped into a plug-in socket system. The arduous task of power supply and connection is done. In addition to savings in time and money, another advantage of the system is the quick and easy exchangeability of the devices. If the corresponding spare capacity is planned, subsequent expansion consists merely of plugging in and connecting additional devices.

The new generation of electrical protective devices in a system:

- Flexible, fast and modular
- Free choice for concept and layout
- Time-saving by planning and assembly

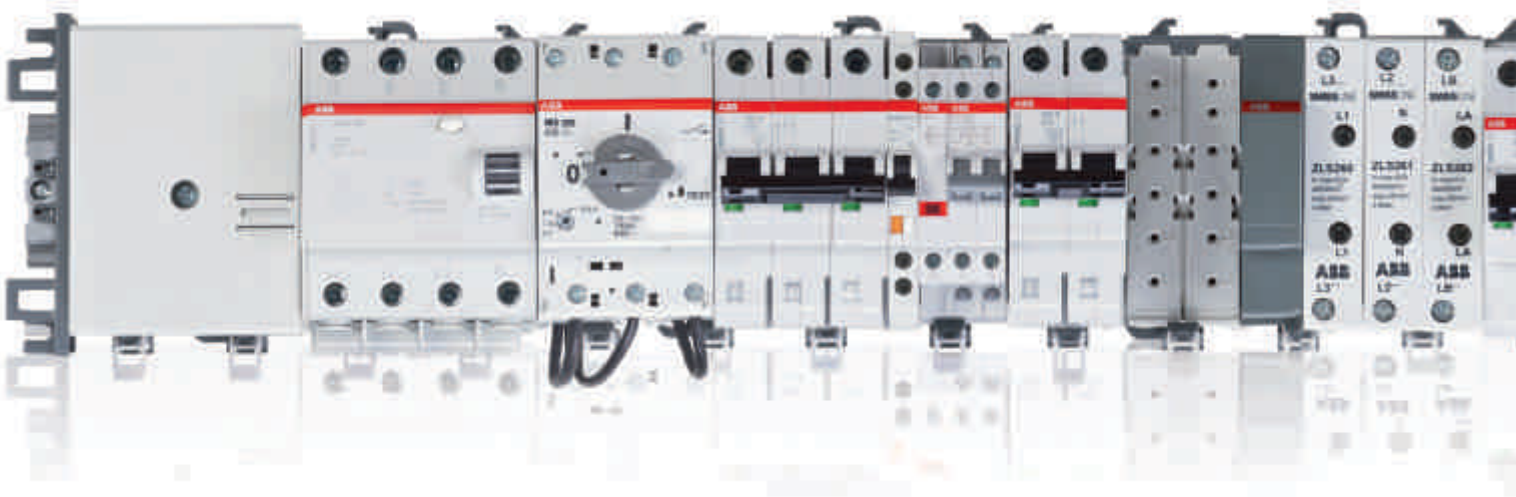

Avoid uneven loads

The phase connection can be identified without removing the devices.

Flexibility up to the last minute

SMISLINE makes it possible to press ahead with planning, even before all the details of a system are known. Loads can be easily reassigned. Even if the usage of an entire installation is completely changed, the effort in-volved remains small.

Freedom to design and arrange

SMISLINE gives you freedom of choice: Mixed-pole arrangement of all devices next to each other.



Six protection devices in one system

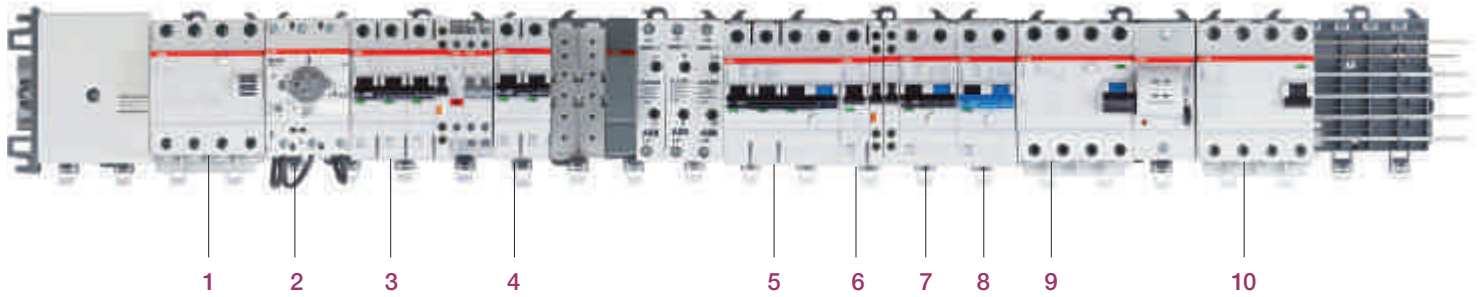

- 1 Surge arrester
- 2 High performance manual motor starter
- 3 Miniature circuit breaker 3 pole
- 4 Miniature circuit breaker 2 pole
- 5 4-pole residual current operated circuit breaker with overcurrent protection
- 6 Miniature circuit breaker 1 pole
- 7 2-pole residual current operated circuit breaker with overcurrent protection
- 8 2-pole residual current operated circuit breaker
- 9 4-pole residual current operated circuit breaker
- 10 Switch disconnecter

Table of contents

SMISSLINE

Miniature circuit breaker S400

Miniature circuit breaker S400 M-B	1/2
Miniature circuit breaker S400 M-C	1/3
Miniature circuit breaker S400 M-D	1/4
Miniature circuit breaker S400 M-K	1/5
Miniature circuit breaker S400 M-B with protected neutral	1/6
Miniature circuit breaker S400 M-C with protected neutral	1/7
Miniature circuit breaker S400 M-D with protected neutral	1/8
Miniature circuit breaker S400 M-K with protected neutral	1/9
Miniature circuit breaker S400 UC	1/10
Miniature circuit breaker S400 UU, DC application	1/11

Residual current operated circuit breaker with over current protection (RCBO)

2-pole residual current operated circuit breaker with overcurrent protection FS401	1/12
4-pole residual current operated circuit breaker with over current protection FS403	1/13

Residual current operated circuit breaker F404, F402

2-pole and 4-pole residual current operated circuit breaker F402, F404	1/14
---	------

Overcurrent arrester OVR404, switch disconnecter IS404

Surge arrester, Switch disconnecter	1/15
-------------------------------------	------

High performance motor starter MS325

Adapter for motor starter MS325	1/15
---------------------------------	------

Accessory

Auxiliary switch and signal contacts	1/16
Dummy, housing, Neutral disconnecter, shunt trip	1/17
F4C-ARI motor operating devices	1/18

Busbar system

Starter pack	1/19
Sockets, Additional socket	1/20
Additional socket, terminals	1/21–22
Incoming terminal block and components	1/23
Socket accessories	1/24
Combi module 32 A	1/25
32 A and 63 A universal adapters	1/26–27
Miscellaneous accessories	1/27
Busbars/selection table for sockets	1/28

Series S400 M-B

Miniature circuit breaker $I_{cn} = 10 \text{ kA}$

B according to EN 60898-1

I_{cn} [kA]	I_n [A]	Type name	ABB IT number	EAN number	Pack- aging unit	Module	Weight in grams
761 227							
10	4	S401 M-B 4	2CCS571001R0045	010 1214	10	1	141
10	6	S401 M-B 6	2CCS571001R0065	010 1221	10	1	141
10	8	S401 M-B 8	2CCS571001R0085	010 8411	10	1	141
10	10	S401 M-B 10	2CCS571001R0105	010 1238	10	1	141
10	13	S401 M-B 13	2CCS571001R0135	010 1245	10	1	141
10	16	S401 M-B 16	2CCS571001R0165	010 1252	10	1	141
10	20	S401 M-B 20	2CCS571001R0205	010 1269	10	1	141
10	25	S401 M-B 25	2CCS571001R0255	010 1276	10	1	141
10	32	S401 M-B 32	2CCS571001R0325	010 1283	10	1	141
10	40	S401 M-B 40	2CCS571001R0405	010 1290	10	1	141
10	50	S401 M-B 50	2CCS571001R0505	010 1306	10	1	141
10	63	S401 M-B 63	2CCS571001R0635	010 1313	10	1	141
10	4	S402 M-B 4	2CCS572001R0045	010 1986	5	2	282
10	6	S402 M-B 6	2CCS572001R0065	010 1993	5	2	282
10	8	S402 M-B 8	2CCS572001R0085	010 8428	5	2	282
10	10	S402 M-B 10	2CCS572001R0105	010 2006	5	2	282
10	13	S402 M-B 13	2CCS572001R0135	010 2013	5	2	282
10	16	S402 M-B 16	2CCS572001R0165	010 2020	5	2	282
10	20	S402 M-B 20	2CCS572001R0205	010 2037	5	2	282
10	25	S402 M-B 25	2CCS572001R0255	010 2044	5	2	282
10	32	S402 M-B 32	2CCS572001R0325	010 2051	5	2	282
10	40	S402 M-B 40	2CCS572001R0405	010 2068	5	2	282
10	50	S402 M-B 50	2CCS572001R0505	010 2075	5	2	282
10	63	S402 M-B 63	2CCS572001R0635	010 2082	5	2	282
10	4	S403 M-B 4	2CCS573001R0045	010 2754	3	3	423
10	6	S403 M-B 6	2CCS573001R0065	010 2761	3	3	423
10	8	S403 M-B 8	2CCS573001R0085	010 8435	3	3	423
10	10	S403 M-B 10	2CCS573001R0105	010 2778	3	3	423
10	13	S403 M-B 13	2CCS573001R0135	010 2785	3	3	423
10	16	S403 M-B 16	2CCS573001R0165	010 2792	3	3	423
10	20	S403 M-B 20	2CCS573001R0205	010 2808	3	3	423
10	25	S403 M-B 25	2CCS573001R0255	010 2815	3	3	423
10	32	S403 M-B 32	2CCS573001R0325	010 2822	3	3	423
10	40	S403 M-B 40	2CCS573001R0405	010 2839	3	3	423
10	50	S403 M-B 50	2CCS573001R0505	010 2846	3	3	423
10	63	S403 M-B 63	2CCS573001R0635	010 2853	3	3	423

Ordering details for auxiliary switch and signal contacts on page 1/16



Series S400 M-C

Miniature circuit breaker $I_{cn} = 10 \text{ kA}$, $I_{cu} = 10 \dots 50 \text{ kA}$

C according to EN 60898-1 and IEC/EN 60947-2



I_{cu} EN 60947-2 [kA]	I_{cn} EN 60898-1 [kA]	I_n [A]	Type name	ABB IT number	EAN number 761 227	Pack- aging unit	Module	Weight in grams
50	10	0.5	S401 M-C 0.5	2CCS571001R0984	010 1320	10	1	141
50	10	1	S401 M-C 1	2CCS571001R0014	010 1337	10	1	141
50	10	1.6	S401 M-C 1.6	2CCS571001R0974	010 1344	10	1	141
50	10	2	S401 M-C 2	2CCS571001R0024	010 1351	10	1	141
25	10	3	S401 M-C 3	2CCS571001R0034	010 1368	10	1	141
25	10	4	S401 M-C 4	2CCS571001R0044	010 1375	10	1	141
25	10	6	S401 M-C 6	2CCS571001R0064	010 1382	10	1	141
25	10	8	S401 M-C 8	2CCS571001R0084	010 1399	10	1	141
25	10	10	S401 M-C 10	2CCS571001R0104	010 1405	10	1	141
25	10	13	S401 M-C 13	2CCS571001R0134	010 1412	10	1	141
25	10	16	S401 M-C 16	2CCS571001R0164	010 1429	10	1	141
25	10	20	S401 M-C 20	2CCS571001R0204	010 1436	10	1	141
10	10	25	S401 M-C 25	2CCS571001R0254	010 1443	10	1	141
10	10	32	S401 M-C 32	2CCS571001R0324	010 1450	10	1	141
10	10	40	S401 M-C 40	2CCS571001R0404	010 1467	10	1	141
10	10	50	S401 M-C 50	2CCS571001R0504	010 1474	10	1	141
10	10	63	S401 M-C 63	2CCS571001R0634	010 1481	10	1	141



50	10	0.5	S402 M-C 0.5	2CCS572001R0984	010 2099	5	2	282
50	10	1	S402 M-C 1	2CCS572001R0014	010 2105	5	2	282
50	10	1.6	S402 M-C 1.6	2CCS572001R0974	010 2112	5	2	282
50	10	2	S402 M-C 2	2CCS572001R0024	010 2129	5	2	282
25	10	3	S402 M-C 3	2CCS572001R0034	010 2136	5	2	282
25	10	4	S402 M-C 4	2CCS572001R0044	010 2143	5	2	282
25	10	6	S402 M-C 6	2CCS572001R0064	010 2150	5	2	282
25	10	8	S402 M-C 8	2CCS572001R0084	010 2167	5	2	282
25	10	10	S402 M-C 10	2CCS572001R0104	010 2174	5	2	282
25	10	13	S402 M-C 13	2CCS572001R0134	010 2181	5	2	282
25	10	16	S402 M-C 16	2CCS572001R0164	010 2198	5	2	282
25	10	20	S402 M-C 20	2CCS572001R0204	010 2204	5	2	282
10	10	25	S402 M-C 25	2CCS572001R0254	010 2211	5	2	282
10	10	32	S402 M-C 32	2CCS572001R0324	010 2228	5	2	282
10	10	40	S402 M-C 40	2CCS572001R0404	010 2235	5	2	282
10	10	50	S402 M-C 50	2CCS572001R0504	010 2242	5	2	282
10	10	63	S402 M-C 63	2CCS572001R0634	010 2259	5	2	282



50	10	0.5	S403 M-C 0.5	2CCS573001R0984	010 2860	3	3	423
50	10	1	S403 M-C 1	2CCS573001R0014	010 2877	3	3	423
50	10	1.6	S403 M-C 1.6	2CCS573001R0974	010 2884	3	3	423
50	10	2	S403 M-C 2	2CCS573001R0024	010 2891	3	3	423
25	10	3	S403 M-C 3	2CCS573001R0034	010 2907	3	3	423
25	10	4	S403 M-C 4	2CCS573001R0044	010 2914	3	3	423
25	10	6	S403 M-C 6	2CCS573001R0064	010 2921	3	3	423
25	10	8	S403 M-C 8	2CCS573001R0084	010 2938	3	3	423
25	10	10	S403 M-C 10	2CCS573001R0104	010 2945	3	3	423
25	10	13	S403 M-C 13	2CCS573001R0134	010 2952	3	3	423
25	10	16	S403 M-C 16	2CCS573001R0164	010 2969	3	3	423
25	10	20	S403 M-C 20	2CCS573001R0204	010 2976	3	3	423
10	10	25	S403 M-C 25	2CCS573001R0254	010 2983	3	3	423
10	10	32	S403 M-C 32	2CCS573001R0324	010 2990	3	3	423
10	10	40	S403 M-C 40	2CCS573001R0404	010 3003	3	3	423
10	10	50	S403 M-C 50	2CCS573001R0504	010 3010	3	3	423
10	10	63	S403 M-C 63	2CCS573001R0634	010 3027	3	3	423

Series S400 M-D

Miniature circuit breaker $I_{cn} = 10 \text{ kA}$

D according to EN 60898-1

I_{cn} [kA]	I_n [A]	Type name	ABB IT number	EAN number 761 227	Pack- aging unit	Module	Weight in grams
10	6	S401 M-D 6	2CCS571001R0061	010 1498	10	1	141
10	8	S401 M-D 8	2CCS571001R0081	010 1504	10	1	141
10	10	S401 M-D 10	2CCS571001R0101	010 1511	10	1	141
10	13	S401 M-D 13	2CCS571001R0131	010 1528	10	1	141
10	16	S401 M-D 16	2CCS571001R0161	010 1535	10	1	141
10	20	S401 M-D 20	2CCS571001R0201	010 1542	10	1	141
10	25	S401 M-D 25	2CCS571001R0251	010 1559	10	1	141
10	32	S401 M-D 32	2CCS571001R0321	010 1566	10	1	141
10	40	S401 M-D 40	2CCS571001R0401	010 1573	10	1	141
10	50	S401 M-D 50	2CCS571001R0501	010 1580	10	1	141
10	63	S401 M-D 63	2CCS571001R0631	010 1597	10	1	141
10	6	S402 M-D 6	2CCS572001R0061	010 2266	5	2	282
10	8	S402 M-D 8	2CCS572001R0081	010 2273	5	2	282
10	10	S402 M-D 10	2CCS572001R0101	010 2280	5	2	282
10	13	S402 M-D 13	2CCS572001R0131	010 2297	5	2	282
10	16	S402 M-D 16	2CCS572001R0161	010 2303	5	2	282
10	20	S402 M-D 20	2CCS572001R0201	010 2310	5	2	282
10	25	S402 M-D 25	2CCS572001R0251	010 2327	5	2	282
10	32	S402 M-D 32	2CCS572001R0321	010 2334	5	2	282
10	40	S402 M-D 40	2CCS572001R0401	010 2341	5	2	282
10	50	S402 M-D 50	2CCS572001R0501	010 2358	5	2	282
10	63	S402 M-D 63	2CCS572001R0631	010 2365	5	2	282
10	6	S403 M-D 6	2CCS573001R0061	010 3034	3	3	423
10	8	S403 M-D 8	2CCS573001R0081	010 3041	3	3	423
10	10	S403 M-D 10	2CCS573001R0101	010 3058	3	3	423
10	13	S403 M-D 13	2CCS573001R0131	010 3065	3	3	423
10	16	S403 M-D 16	2CCS573001R0161	010 3072	3	3	423
10	20	S403 M-D 20	2CCS573001R0201	010 3089	3	3	423
10	25	S403 M-D 25	2CCS573001R0251	010 3096	3	3	423
10	32	S403 M-D 32	2CCS573001R0321	010 3102	3	3	423
10	40	S403 M-D 40	2CCS573001R0401	010 3119	3	3	423
10	50	S403 M-D 50	2CCS573001R0501	010 3126	3	3	423
10	63	S403 M-D 63	2CCS573001R0631	010 3133	3	3	423

Ordering details for auxiliary switch and signal contacts on page 1/16



Series S400 M-K

Miniature circuit breaker (MCB) $I_{cu} = 10 \dots 50 \text{ kA}$

K according to IEC/EN 60947-2



I_{cu} [kA]	I_n [A]	Type name	ABB IT number	EAN number 761 227	Pack- aging unit	Module	Weight in grams
50	0.5	S401 M-K 0.5	2CCS571001R0157	010 1603	10	1	141
50	1	S401 M-K 1	2CCS571001R0217	010 1610	10	1	141
50	1.6	S401 M-K 1.6	2CCS571001R0257	010 1627	10	1	141
50	2	S401 M-K 2	2CCS571001R0277	010 1634	10	1	141
25	3	S401 M-K 3	2CCS571001R0317	010 1641	10	1	141
25	4	S401 M-K 4	2CCS571001R0337	010 1658	10	1	141
25	6	S401 M-K 6	2CCS571001R0377	010 1665	10	1	141
25	8	S401 M-K 8	2CCS571001R0407	010 1672	10	1	141
25	10	S401 M-K 10	2CCS571001R0427	010 1689	10	1	141
25	13	S401 M-K 13	2CCS571001R0447	010 1696	10	1	141
25	16	S401 M-K 16	2CCS571001R0467	010 1702	10	1	141
25	20	S401 M-K 20	2CCS571001R0487	010 1719	10	1	141
10	25	S401 M-K 25	2CCS571001R0517	010 1726	10	1	141
10	32	S401 M-K 32	2CCS571001R0537	010 1733	10	1	141
10	40	S401 M-K 40	2CCS571001R0557	010 1740	10	1	141
10	50	S401 M-K 50	2CCS571001R0577	010 1757	10	1	141
10	63	S401 M-K 63	2CCS571001R0597	010 1764	10	1	141



50	0.5	S402 M-K 0.5	2CCS572001R0157	010 2372	5	2	282
50	1	S402 M-K 1	2CCS572001R0217	010 2389	5	2	282
50	1.6	S402 M-K 1.6	2CCS572001R0257	010 2396	5	2	282
50	2	S402 M-K 2	2CCS572001R0277	010 2402	5	2	282
25	3	S402 M-K 3	2CCS572001R0317	010 2419	5	2	282
25	4	S402 M-K 4	2CCS572001R0337	010 2426	5	2	282
25	6	S402 M-K 6	2CCS572001R0377	010 2433	5	2	282
25	8	S402 M-K 8	2CCS572001R0407	010 2440	5	2	282
25	10	S402 M-K 10	2CCS572001R0427	010 2457	5	2	282
25	13	S402 M-K 13	2CCS572001R0447	010 2464	5	2	282
25	16	S402 M-K 16	2CCS572001R0467	010 2471	5	2	282
25	20	S402 M-K 20	2CCS572001R0487	010 2488	5	2	282
10	25	S402 M-K 25	2CCS572001R0517	010 2495	5	2	282
10	32	S402 M-K 32	2CCS572001R0537	010 2501	5	2	282
10	40	S402 M-K 40	2CCS572001R0557	010 2518	5	2	282
10	50	S402 M-K 50	2CCS572001R0577	010 2525	5	2	282
10	63	S402 M-K 63	2CCS572001R0597	010 2532	5	2	282



50	0.5	S403 M-K 0.5	2CCS573001R0157	010 3140	3	3	423
50	1	S403 M-K 1	2CCS573001R0217	010 3157	3	3	423
50	1.6	S403 M-K 1.6	2CCS573001R0257	010 3164	3	3	423
50	2	S403 M-K 2	2CCS573001R0277	010 3171	3	3	423
25	3	S403 M-K 3	2CCS573001R0317	010 3188	3	3	423
25	4	S403 M-K 4	2CCS573001R0337	010 3195	3	3	423
25	6	S403 M-K 6	2CCS573001R0377	010 3201	3	3	423
25	8	S403 M-K 8	2CCS573001R0407	010 3218	3	3	423
25	10	S403 M-K 10	2CCS573001R0427	010 3225	3	3	423
25	13	S403 M-K 13	2CCS573001R0447	010 3232	3	3	423
25	16	S403 M-K 16	2CCS573001R0467	010 3249	3	3	423
25	20	S403 M-K 20	2CCS573001R0487	010 3256	3	3	423
10	25	S403 M-K 25	2CCS573001R0517	010 3263	3	3	423
10	32	S403 M-K 32	2CCS573001R0537	010 3270	3	3	423
10	40	S403 M-K 40	2CCS573001R0557	010 3287	3	3	423
10	50	S403 M-K 50	2CCS573001R0577	010 3294	3	3	423
10	63	S403 M-K 63	2CCS573001R0597	010 3300	3	3	423

S400 M-B

Miniature circuit breaker with protected neutral $I_{cn} = 10 \text{ kA}$

B according to EN 60898-1

I_{cn} [kA]	I_n [A]	Type name	ABB IT number	EAN number	Pack- aging unit	Module	Weight in grams
761 227							
10	6	S401 M-B 6NP	2CCS571103R8065	010 3317	5	2	282
10	8	S401 M-B 8NP	2CCS571103R8085	010 8473	5	2	282
10	10	S401 M-B 10NP	2CCS571103R8105	010 3324	5	2	282
10	13	S401 M-B 13NP	2CCS571103R8135	010 3331	5	2	282
10	16	S401 M-B 16NP	2CCS571103R8165	010 3348	5	2	282
10	20	S401 M-B 20NP	2CCS571103R8205	010 3355	5	2	282
10	25	S401 M-B 25NP	2CCS571103R8255	010 3362	5	2	282
10	32	S401 M-B 32NP	2CCS571103R8325	010 3379	5	2	282
10	40	S401 M-B 40NP	2CCS571103R8405	010 3386	5	2	282
10	50	S401 M-B 50NP	2CCS571103R8505	010 3393	5	2	282
10	63	S401 M-B 63NP	2CCS571103R8635	010 3409	5	2	282

10	6	S403 M-B 6NP	2CCS573103R8065	010 3782	2	4	564
10	8	S403 M-B 8NP	2CCS573103R8085	010 8510	2	4	564
10	10	S403 M-B 10NP	2CCS573103R8105	010 3799	2	4	564
10	13	S403 M-B 13NP	2CCS573103R8135	010 3805	2	4	564
10	16	S403 M-B 16NP	2CCS573103R8165	010 3812	2	4	564
10	20	S403 M-B 20NP	2CCS573103R8205	010 3829	2	4	564
10	25	S403 M-B 25NP	2CCS573103R8255	010 3836	2	4	564
10	32	S403 M-B 32NP	2CCS573103R8325	010 3843	2	4	564
10	40	S403 M-B 40NP	2CCS573103R8405	010 3850	2	4	564
10	50	S403 M-B 50NP	2CCS573103R8505	010 3867	2	4	564
10	63	S403 M-B 63NP	2CCS573103R8635	010 3874	2	4	564

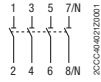

Ordering details for auxiliary switch and signal contacts on page 1/16
 The neutral is protected with 100% of the nominal value of the pole conductor

S400 M-C

MCB with protected neutral $I_{cn} = 10 \text{ kA}$, $I_{cu} = 10 \dots 50 \text{ kA}$

C according to EN 60898-1 and IEC/EN 60947-2



2CC451014F0001



2CC451018F0001

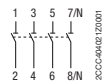

I_{cu} nach 60947-1 [kA]	I_{cn} nach 60898-1 [kA]	I_n [A]	Type name	ABB IT Number	EAN number 761 227	Pack- aging unit	Module	Weight in grams
50	10	2	S401 M-C 2NP	2CCS571103R8024	010 8480	5	2	282
25	10	3	S401 M-C 3NP	2CCS571103R8034	010 8497	5	2	282
25	10	4	S401 M-C 4NP	2CCS571103R8044	010 8503	5	2	282
25	10	6	S401 M-C 6NP	2CCS571103R8064	010 3416	5	2	282
25	10	8	S401 M-C 8NP	2CCS571103R8084	010 3423	5	2	282
25	10	10	S401 M-C 10NP	2CCS571103R8104	010 3430	5	2	282
25	10	13	S401 M-C 13NP	2CCS571103R8134	010 3447	5	2	282
25	10	16	S401 M-C 16NP	2CCS571103R8164	010 3454	5	2	282
25	10	20	S401 M-C 20NP	2CCS571103R8204	010 3461	5	2	282
10	10	25	S401 M-C 25NP	2CCS571103R8254	010 3478	5	2	282
10	10	32	S401 M-C 32NP	2CCS571103R8324	010 3485	5	2	282
10	10	40	S401 M-C 40NP	2CCS571103R8404	010 3492	5	2	282
10	10	50	S401 M-C 50NP	2CCS571103R8504	010 3508	5	2	282
10	10	63	S401 M-C 63NP	2CCS571103R8634	010 3515	5	2	282
50	10	2	S403 M-C 2NP	2CCS573103R8024	010 8527	2	4	564
25	10	3	S403 M-C 3NP	2CCS573103R8034	010 8534	2	4	564
25	10	4	S403 M-C 4NP	2CCS573103R8044	010 8541	2	4	564
25	10	6	S403 M-C 6NP	2CCS573103R8064	010 3881	2	4	564
25	10	8	S403 M-C 8NP	2CCS573103R8084	010 3898	2	4	564
25	10	10	S403 M-C 10NP	2CCS573103R8104	010 3904	2	4	564
25	10	13	S403 M-C 13NP	2CCS573103R8134	010 3911	2	4	564
25	10	16	S403 M-C 16NP	2CCS573103R8164	010 3928	2	4	564
25	10	20	S403 M-C 20NP	2CCS573103R8204	010 3935	2	4	564
10	10	25	S403 M-C 25NP	2CCS573103R8254	010 3942	2	4	564
10	10	32	S403 M-C 32NP	2CCS573103R8324	010 3959	2	4	564
10	10	40	S403 M-C 40NP	2CCS573103R8404	010 3966	2	4	564
10	10	50	S403 M-C 50NP	2CCS573103R8504	010 3973	2	4	564
10	10	63	S403 M-C 63NP	2CCS573103R8634	010 3980	2	4	564

Ordering details for auxiliary switch and signal contacts on page 1/16
 The neutral is protected with 100% of the nominal value of the pole conductor

S400 M-D

Miniature circuit breaker with protected neutral $I_{cn} = 10 \text{ kA}$

D according to EN 60898-1

I_{cn} [kA]	I_n [A]	Type name	ABB IT number	EAN number 761 227	Pack- aging unit	Module	Weight in grams
10	10	S401 M-D 10NP	2CCS571103R8101	010 3522	5	2	282
10	13	S401 M-D 13NP	2CCS571103R8131	010 3539	5	2	282
10	16	S401 M-D 16NP	2CCS571103R8161	010 3546	5	2	282
10	20	S401 M-D 20NP	2CCS571103R8201	010 3553	5	2	282
10	25	S401 M-D 25NP	2CCS571103R8251	010 3560	5	2	282
10	32	S401 M-D 32NP	2CCS571103R8321	010 3577	5	2	282
10	40	S401 M-D 40NP	2CCS571103R8401	010 3584	5	2	282
10	50	S401 M-D 50NP	2CCS571103R8501	010 3591	5	2	282
10	63	S401 M-D 63NP	2CCS571103R8631	010 3607	5	2	282
10	10	S403 M-D 10NP	2CCS573103R8101	010 3997	2	4	564
10	13	S403 M-D 13NP	2CCS573103R8131	010 4000	2	4	564
10	16	S403 M-D 16NP	2CCS573103R8161	010 4017	2	4	564
10	20	S403 M-D 20NP	2CCS573103R8201	010 4024	2	4	564
10	25	S403 M-D 25NP	2CCS573103R8251	010 4031	2	4	564
10	32	S403 M-D 32NP	2CCS573103R8321	010 4048	2	4	564
10	40	S403 M-D 40NP	2CCS573103R8401	010 4055	2	4	564
10	50	S403 M-D 50NP	2CCS573103R8501	010 4062	2	4	564
10	63	S403 M-D 63NP	2CCS573103R8631	010 4079	2	4	564

Ordering details for auxiliary switch and signal contacts on page 1/16

The neutral is protected with 100% of the nominal value of the pole conductor



2CCS451015F0001



2CCS451019F0001



S400 M-K

Miniature circuit breaker with protected neutral $I_{cu} = 10 \dots 50 \text{ kA}$



2CCS451016F0001



2CCS451020F0001



K according to IEC/EN 60947-2

I_{cu} [kA]	I_n [A]	Type name	ABB IT number	EAN number 761 227	Pack- aging unit	Module	Weight in grams
50	0.5	S401 M-K 0.5NP	2CCS571103R8157	010 3614	5	2	282
50	1	S401 M-K 1NP	2CCS571103R8217	010 3621	5	2	282
50	1.6	S401 M-K 1.6NP	2CCS571103R8257	010 3638	5	2	282
50	2	S401 M-K 2NP	2CCS571103R8277	010 3645	5	2	282
25	3	S401 M-K 3NP	2CCS571103R8317	010 3652	5	2	282
25	4	S401 M-K 4NP	2CCS571103R8337	010 3669	5	2	282
25	6	S401 M-K 6NP	2CCS571103R8377	010 3676	5	2	282
25	8	S401 M-K 8NP	2CCS571103R8407	010 3683	5	2	282
25	10	S401 M-K 10NP	2CCS571103R8427	010 3690	5	2	282
25	13	S401 M-K 13NP	2CCS571103R8447	010 3706	5	2	282
25	16	S401 M-K 16NP	2CCS571103R8467	010 3713	5	2	282
25	20	S401 M-K 20NP	2CCS571103R8487	010 3720	5	2	282
10	25	S401 M-K 25NP	2CCS571103R8517	010 3737	5	2	282
10	32	S401 M-K 32NP	2CCS571103R8537	010 3744	5	2	282
10	40	S401 M-K 40NP	2CCS571103R8557	010 3751	5	2	282
10	50	S401 M-K 50NP	2CCS571103R8577	010 3768	5	2	282
10	63	S401 M-K 63NP	2CCS571103R8597	010 3775	5	2	282
50	0.5	S403 M-K 0.5NP	2CCS573103R8157	010 4086	2	4	564
50	1	S403 M-K 1NP	2CCS573103R8217	010 4093	2	4	564
50	1.6	S403 M-K 1.6NP	2CCS573103R8257	010 4109	2	4	564
50	2	S403 M-K 2NP	2CCS573103R8277	010 4116	2	4	564
25	3	S403 M-K 3NP	2CCS573103R8317	010 4123	2	4	564
25	4	S403 M-K 4NP	2CCS573103R8337	010 4130	2	4	564
25	6	S403 M-K 6NP	2CCS573103R8377	010 4147	2	4	564
25	8	S403 M-K 8NP	2CCS573103R8407	010 4154	2	4	564
25	10	S403 M-K 10NP	2CCS573103R8427	010 4161	2	4	564
25	13	S403 M-K 13NP	2CCS573103R8447	010 4178	2	4	564
25	16	S403 M-K 16NP	2CCS573103R8467	010 4185	2	4	564
25	20	S403 M-K 20NP	2CCS573103R8487	010 4192	2	4	564
10	25	S403 M-K 25NP	2CCS573103R8517	010 4208	2	4	564
10	32	S403 M-K 32NP	2CCS573103R8537	010 4215	2	4	564
10	40	S403 M-K 40NP	2CCS573103R8557	010 4222	2	4	564
10	50	S403 M-K 50NP	2CCS573103R8577	010 4239	2	4	564
10	63	S403 M-K 63NP	2CCS573103R8597	010 4246	2	4	564

Ordering details for auxiliary switch and signal contacts on page 1/16
The neutral is protected with 100% of the nominal value of the pole conductor

S400 UC application

Miniature circuit breaker $I_{cu} = 10 \dots 50 \text{ kA}$

C according to IEC/EN 60947-2

I_{cu} [kA]	I_n [A]	Type name	ABB IT number	EAN number	Pack- aging unit	Module	Weight in grams
761 227							
50	0.5	S401M-UCC0.5	2CCS561001R1984	010 9746	10	1	145
50	1	S401M-UCC1	2CCS561001R1014	010 9753	10	1	145
50	1.6	S401M-UCC1.6	2CCS561001R1974	010 9760	10	1	145
50	2	S401M-UCC2	2CCS561001R1024	010 9777	10	1	145
10	3	S401M-UCC3	2CCS571001R1034	010 9784	10	1	145
10	4	S401M-UCC4	2CCS571001R1044	010 9791	10	1	145
10	6	S401M-UCC6	2CCS571001R1064	010 9807	10	1	145
10	8	S401M-UCC8	2CCS571001R1084	010 9814	10	1	145
10	10	S401M-UCC10	2CCS571001R1104	010 9821	10	1	145
10	13	S401M-UCC13	2CCS571001R1134	010 9838	10	1	145
10	16	S401M-UCC16	2CCS571001R1164	010 9845	10	1	145
10	20	S401M-UCC20	2CCS571001R1204	010 9852	10	1	145
10	25	S401M-UCC25	2CCS571001R1254	010 9869	10	1	145
10	32	S401M-UCC32	2CCS571001R1324	010 9876	10	1	145
10	40	S401M-UCC40	2CCS571001R1404	010 9883	10	1	145
10	50	S401M-UCC50	2CCS571001R1504	010 9890	10	1	145
10	63	S401M-UCC63	2CCS571001R1634	010 9906	10	1	145
50	0.5	S402M-UCC0.5	2CCS562001R1984	010 9913	5	2	290
50	1	S402M-UCC1	2CCS562001R1014	010 9920	5	2	290
50	1.6	S402M-UCC1.6	2CCS562001R1974	010 9937	5	2	290
50	2	S402M-UCC2	2CCS562001R1024	010 9944	5	2	290
10	3	S402M-UCC3	2CCS572001R1034	010 9951	5	2	290
10	4	S402M-UCC4	2CCS572001R1044	010 9968	5	2	290
10	6	S402M-UCC6	2CCS572001R1064	010 9975	5	2	290
10	8	S402M-UCC8	2CCS572001R1084	010 9982	5	2	290
10	10	S402M-UCC10	2CCS572001R1104	010 9999	5	2	290
10	13	S402M-UCC13	2CCS572001R1134	011 0001	5	2	290
10	16	S402M-UCC16	2CCS572001R1164	011 0018	5	2	290
10	20	S402M-UCC20	2CCS572001R1204	011 0025	5	2	290
10	25	S402M-UCC25	2CCS572001R1254	011 0032	5	2	290
10	32	S402M-UCC32	2CCS572001R1324	011 0049	5	2	290
10	40	S402M-UCC40	2CCS572001R1404	011 0056	5	2	290
10	50	S402M-UCC50	2CCS572001R1504	011 0063	5	2	290
10	63	S402M-UCC63	2CCS572001R1634	011 0070	5	2	290



1 P 125 V=



2 P 250 V=



Ordering details for auxiliary switch and signal contacts on page 1/16

Connection diagram,
single-pole (max. 125 V=) S401M-UCC

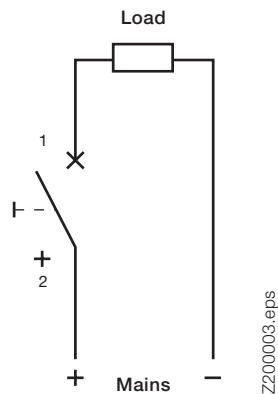

Connection diagram,
two-pole (max. 250 V=) S402M-UCC

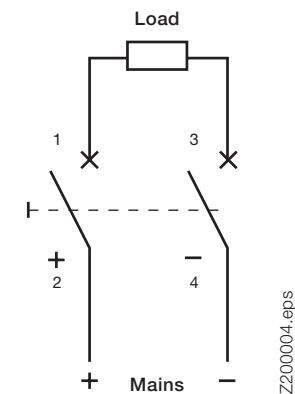

S400 UC, DC application

Miniature circuit breaker $I_{cu} = 10 \dots 50 \text{ kA}$



1 P 125 V=



2C0CC451317F0001



2 P 250 V=



2C0CC451319F0001

K according to IEC/EN 60947-2

I_{cu} [kA]	I_n [A]	Type name	ABB IT number	EAN number	Pack- aging unit	Module	Weight in grams
761 227							
50	0.5	S401M-UCZ0.5	2CCS561001R1988	011 0087	10	1	145
50	1	S401M-UCZ1	2CCS561001R1018	011 0094	10	1	145
50	1.6	S401M-UCZ1.6	2CCS561001R1978	011 0100	10	1	145
50	2	S401M-UCZ2	2CCS561001R1028	011 0117	10	1	145
10	3	S401M-UCZ3	2CCS571001R1038	011 0124	10	1	145
10	4	S401M-UCZ4	2CCS571001R1048	011 0131	10	1	145
10	6	S401M-UCZ6	2CCS571001R1068	011 0148	10	1	145
10	8	S401M-UCZ8	2CCS571001R1088	011 0155	10	1	145
10	10	S401M-UCZ10	2CCS571001R1108	011 0162	10	1	145
10	13	S401M-UCZ13	2CCS571001R1138	011 0179	10	1	145
10	16	S401M-UCZ16	2CCS571001R1168	011 0186	10	1	145
10	20	S401M-UCZ20	2CCS571001R1208	011 0193	10	1	145
10	25	S401M-UCZ25	2CCS571001R1258	011 0209	10	1	145
10	32	S401M-UCZ32	2CCS571001R1328	011 0216	10	1	145
10	40	S401M-UCZ40	2CCS571001R1408	011 0223	10	1	145
10	50	S401M-UCZ50	2CCS571001R1508	011 0230	10	1	145
10	63	S401M-UCZ63	2CCS571001R1638	011 0247	10	1	145
50	0.5	S402M-UCZ0.5	2CCS562001R1988	011 0254	10	2	290
50	1	S402M-UCZ1	2CCS562001R1018	011 0261	10	2	290
50	1.6	S402M-UCZ1.6	2CCS562001R1978	011 0278	10	2	290
50	2	S402M-UCZ2	2CCS562001R1028	011 0285	10	2	290
10	3	S402M-UCZ3	2CCS572001R1038	011 0292	10	2	290
10	4	S402M-UCZ4	2CCS572001R1048	011 0308	10	2	290
10	6	S402M-UCZ6	2CCS572001R1068	011 0315	10	2	290
10	8	S402M-UCZ8	2CCS572001R1088	011 0322	10	2	290
10	10	S402M-UCZ10	2CCS572001R1108	011 0339	10	2	290
10	13	S402M-UCZ13	2CCS572001R1138	011 0346	10	2	290
10	16	S402M-UCZ16	2CCS572001R1168	011 0353	10	2	290
10	20	S402M-UCZ20	2CCS572001R1208	011 0360	10	2	290
10	25	S402M-UCZ25	2CCS572001R1258	011 0377	10	2	290
10	32	S402M-UCZ32	2CCS572001R1328	011 0384	10	2	290
10	40	S402M-UCZ40	2CCS572001R1408	011 0391	10	2	290
10	50	S402M-UCZ50	2CCS572001R1508	011 0407	10	2	290
10	63	S402M-UCZ63	2CCS572001R1638	011 0414	10	2	290

Ordering details for auxiliary switch and signal contacts on page 1/16

Connection diagram,
single-pole (max. 125 V=) S401M-UCZ

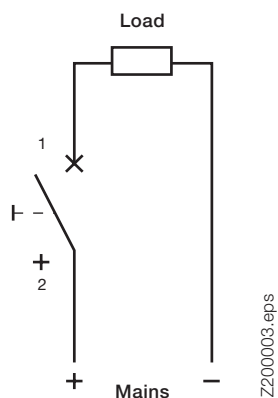

Connection diagram,
two-pole (max. 250 V=) S402M-UCZ

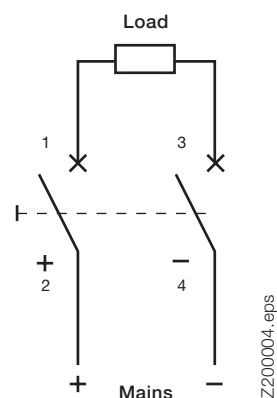

FS401

2-pole RCBO



2CCC451023F0002

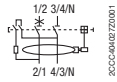

2-pole residual current operated circuit breaker with overcurrent protection, series FS401E (RCBO)

Rated breaking capacity 6 kA, B, C

$I_{\Delta n}$ [mA]	I_n [A]	I_{cn} [kA]	Type name	ABB IT number	EAN number 761 227	Pack- aging unit	Module	Weight in grams
30	13	6	FS401 E-B 13/0.03	2CCL562111E0135	010 8558	2	2	250
30	16	6	FS401 E-B 16/0.03	2CCL562111E0165	010 8565	2	2	250
30	20	6	FS401 E-B 20/0.03	2CCL562111E0205	010 9692	2	2	250
30	25	6	FS401 E-B 25/0.03	2CCL562111E0255	010 9708	2	2	250
30	32	6	FS401 E-B 32/0.03	2CCL562111E0325	010 9715	2	2	250
30	13	6	FS401 E-C 13/0.03	2CCL562111E0134	010 8572	2	2	250
30	16	6	FS401 E-C 16/0.03	2CCL562111E0164	010 8589	2	2	250
30	20	6	FS401 E-C 20/0.03	2CCL562110E0204	010 4574	2	2	250
30	25	6	FS401 E-C 25/0.03	2CCL562110E0254	010 4581	2	2	250
30	32	6	FS401 E-C 32/0.03	2CCL562110E0324	010 4598	2	2	250
100	32	6	FS401 E-C 32/0.1	2CCL562120E0324	140 0446	2	2	250

2-pole residual current operated circuit breaker with overcurrent protection, series FS401M (RCBO)

Rated breaking capacity 10 kA, B, C

30	10	10	FS401 M-B 10/0.03	2CCL562110E0105	010 9685	2	2	250
30	13	10	FS401 M-B 13/0.03	2CCL562110E0135	010 4505	2	2	250
30	16	10	FS401 M-B 16/0.03	2CCL562110E0165	010 4512	2	2	250
10	6	10	FS401 M-C 6/0.01	2CCL562000E0064	140 6493	2	2	250
30	6	10	FS401 M-C 6/0.03	2CCL562010E0064	140 6905	2	2	250
30	10	10	FS401 M-C 10/0.03	2CCL562110E0104	010 4543	2	2	250
10	13	10	FS401 M-C 13/0.01	2CCL562100E0134	010 4529	2	2	250
30	13	10	FS401 M-C 13/0.03	2CCL562110E0134	010 4550	2	2	250
10	16	10	FS401 M-C 16/0.01	2CCL562100E0164	010 4536	2	2	250
30	16	10	FS401 M-C 16/0.03	2CCL562110E0164	010 4567	2	2	250

2-pole short time delayed residual current operated circuit breaker with overcurrent protection series FS401 M K (10 kA) and FS401 E K (RCBO)

Rated breaking capacity 6 kA, C

30	10	10	FS401 M K-C 10/0.03	2CCL562310E0104	140 4031	2	2	250
30	13	10	FS401 M K-C 13/0.03	2CCL562310E0134	010 4604	2	2	250
30	16	10	FS401 M K-C 16/0.03	2CCL562310E0164	010 4611	2	2	250
30	20	6	FS401 E K-C 20/0.03	2CCL562310E0204	010 4628	2	2	250
30	25	6	FS401 E K-C 25/0.03	2CCL562310E0254	010 4635	2	2	250
30	32	6	FS401 E K-C 32/0.03	2CCL562310E0324	010 4642	2	2	250

Ordering details for auxiliary switch and signal contacts on page 1/16

FS403

4-pole RCBO



2CCC451500F0002

4-pole residual current operated circuit breaker with overcurrent protection FS403 (RCBO)

B,C

$I_{\Delta n}$ [mA]	I_n [A]	I_{cn} [kA]	Type	ABB IT number	EAN number 761 227	Pack- aging unit	Module	Gross weight in grams
30	10	10	FS403M-B10/0.03	2CCL564110E0105	140 7612	1	4	545
30	13	10	FS403M-B13/0.03	2CCL564110E0135	140 7629	1	4	545
30	16	10	FS403M-B16/0.03	2CCL564110E0165	140 7636	1	4	545
30	20	6	FS403E-B20/0.03	2CCL564111E0205	140 9357	1	4	545
30	25	6	FS403E-B25/0.03	2CCL564111E0255	140 8763	1	4	545
30	10	10	FS403M-C10/0.03	2CCL564110E0104	140 7674	1	4	545
30	13	10	FS403M-C13/0.03	2CCL564110E0134	140 7681	1	4	545
30	16	10	FS403M-C16/0.03	2CCL564110E0164	140 7698	1	4	545
30	20	6	FS403E-C20/0.03	2CCL564111E0203	140 9609	1	4	545
30	25	6	FS403E-C25/0.03	2CCL564111E0254	140 8770	1	4	545

F402, F404

2- and 4-pole residual current operated circuit breaker



2CCC451022F0002

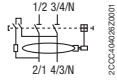

2CCC451022F0001

2-pole residual current operated circuit breaker, series F402 (RCCB)

$I_{\Delta n}$ [mA]	I_n [A]	Type name	ABB IT number	EAN number	Pack- aging unit	Module	Weight in grams
761 227							
10	25	F402 A 25/0.01	2CCF552100E0250	010 4420	2	2	250
30	25	F402 A 25/0.03	2CCF552110E0250	010 4437	2	2	250
30	40	F402 A 40/0.03	2CCF552110E0400	010 4444	2	2	250
100	40	F402 A 40/0.1	2CCF552020E0400	010 9241	2	2	250

2-pole short time delayed residual current operated circuit breaker, series F402 K

30	40	F402 A-K 40/0.03	2CCF552310E0400	010 4482	2	2	250
----	----	------------------	-----------------	----------	---	---	-----



2CCC451025F0001

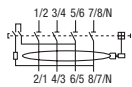

2CCC451025F0001

4-pole residual current operated circuit breaker, series F404 (RCCB)

30	25	F404 A 25/0.03	2CCF544110E0250	010 4253	1	4	430
30	40	F404 A 40/0.03	2CCF544110E0400	010 4260	1	4	430
100	40	F404 A 40/0.1	2CCF544120E0400	010 4277	1	4	430
300	40	F404 A 40/0.3	2CCF544130E0400	010 4284	1	4	430
30	63	F404 A 63/0.03	2CCF544110E0630	010 4291	1	4	430
100	63	F404 A 63/0.1	2CCF544120E0630	010 4307	1	4	430
300	63	F404 A 63/0.3	2CCF544130E0630	010 4314	1	4	430
500	63	F404 A 63/0.5	2CCF600517E0630	140 1566	1	4	430

4-pole short time delayed residual current operated circuit breaker, series F404 K (RCCB)

30	40	F404 A-K 40/0.03	2CCF544310E0400	010 4321	1	4	430
100	40	F404 A-K 40/0.1	2CCF544320E0400	010 4338	1	4	430
30	63	F404 A-K 63/0.03	2CCF544310E0630	010 4345	1	4	430

4-pole selective residual current operated circuit breaker, series F404 S (RCCB)

100	63	F404 A-S 63/0.1	2CCF544220E0630	010 4352	1	4	430
300	63	F404 A-S 63/0.3	2CCF544230E0630	010 4369	1	4	430

4-pole residual current operated circuit breaker, special design 16 2/3 Hz, series F404 LF (RCCB)

30	63	F404 A-LF 63/0.03	2CCF544110E0631	010 4376	1	4	430
300	63	F404 A-LF 63/0.3	2CCF544130E0631	010 4383	1	4	430

Ordering details for auxiliary switch and signal contacts on page 1/16

Surge arrester, Switch disconnecter Adapter for motor starter MS325



2CCC451030F0001

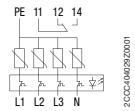

2CCC451030F0001

Surge arrester OVR404

I_{sn} (8/20 μ s) [kA]	Type name	ABB IT number	EAN number	Pack- aging unit	Module	Weight in grams
15	OVR404 TNS	2CCCF544160E0001	010 4406	1	4	430



2CCC451028F0001

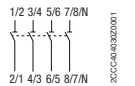

2CCC451028F0001

Switch disconnecter IS404

I_n [A]	Type name	ABB IT number	EAN number	Pack- aging unit	Module	Weight in grams
63	IS404 63	2CCCF544160E0630	010 4390	1	4	380

Ordering details for auxiliary switch and signal contacts on page 1/16



2CCC451121F0001



40160

Adapter plate for MS325 contact to busbars with plug contacts

Type name	ABB IT number	EAN number	Pack- aging unit	Weight in grams
3L	ZMS915	2CCCF002817R0001	002 1215	30
L1, N(20A)	ZMS916	2CCCF002818R0001	002 1222	30
L2, N(20A)	ZMS917	2CCCF002819R0001	002 1239	30
L3, N(20A)	ZMS918	2CCCF002820R0001	002 1246	30
2L (reversible)	ZMS919	2CCCF010620R0001	002 1253	30



40152

Auxiliary switch and signal contacts, connection support Contact pin, short

	ABB IT number	EAN number	Pack- aging unit	Weight in grams
for power supply via auxiliary busbars	2CCCF002794R0001	001 9526	1	2

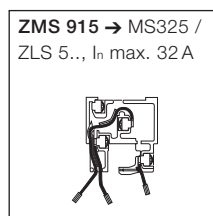

ZMS 915 → MS325 /
ZLS 5.., I_n max. 32 A

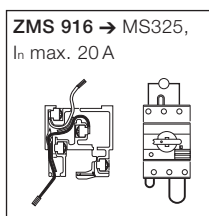

ZMS 916 → MS325,
 I_n max. 20 A

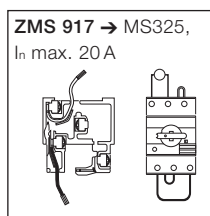

ZMS 917 → MS325,
 I_n max. 20 A

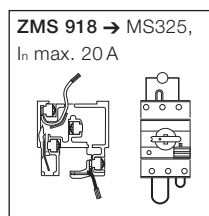

ZMS 918 → MS325,
 I_n max. 20 A

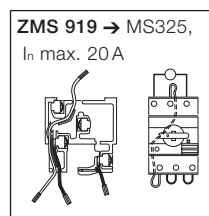

ZMS 919 → MS325,
 I_n max. 20 A

Auxiliary switch and signal contacts

MCB S400, RCCB F404, RCCB F402, RCBO FS401



2CCC451209F0001



2CCC451209F0001



2CCC451210F0001



2CCC451217F0001



2CCC451210F0001



2CCC451217F0001



2CCC451216F0001



2CCC451216F0001



2CCC451212F0001



2CCC451211F0001



2CCC451212F0001



2CCC451211F0001

The auxiliary switch and signal contacts are supplied with one contacting piece. The signal contact collective alarm are supplied with two contacting pieces.

Auxiliary switch

Type name	ABB IT number	EAN number	Pack-aging unit	Module	Weight in grams
761 227					
for left side mounting on MCB S400, RCCB F402, RCBO FS401, FS403					
1NO and 1NC	HK40011-L	2CCS500900R0081	010 0910	10	0.5 45
2NO	HK40020-L	2CCF201112R0001	011 1183	10	0.5 40
2NC	HK40002-L	2CCF201114R0001	011 1190	10	0.5 40
for right side mounting on RCB F404, MCB S400 and IS404					
1NO and 1NC	HK40011-R	2CCS500900R0214	010 8619	10	0.5 45
2NO	HK40020-R	2CCF201113R0001	011 1206	10	0.5 40
2NC	HK40002-R	2CCF201115R0001	011 1213	10	0.5 40

Signal contacts

Type name	ABB IT number	EAN number	Pack-aging unit	Module	Weight in grams
761 227					
for left side mounting on MCB S400, RCCB F402, RCBO FS401, FS403					
1NO and 1NC	SK40011-L	2CCS500900R0101	010 0934	10	0.5 45
2NO	SK40020-L	2CCF201162R0001	011 1107	10	0.5 40
2NC	SK40002-L	2CCF201164R0001	011 1114	10	0.5 40
for right side mounting on RCCB F404 and MCB S400					
1NO and 1NC	SK40011-R	2CCS500900R0215	010 8626	10	0.5 45
2NO	SK40020-R	2CCF201163R0001	011 1121	10	0.5 40
2NC	SK40002-R	2CCF201165R0001	011 1138	10	0.5 40

Signal contact collective alarm and auxiliary contact

Type name	ABB IT number	EAN number	Pack-aging unit	Module	Weight in grams
761 227					
for left side mounting					
1NO	SK40010-L SA	2CCS500900R0141	010 7964	10	0.5 45
1NO	HK40010-L SA	2CCF201212R0001	140 7902	10	0.5 45
for right side mounting					
1NO	SK40010-R SA	2CCS500900R0216	010 8633	10	0.5 45
1NO	HK40010-R SA	2CCF201213R0001	140 7919	10	0.5 45

Collective alarm, signal contact contacts the auxiliary busbars LA, LB

A cost-effective collective alarm solution can be implemented without additional wiring by using this arrangement.

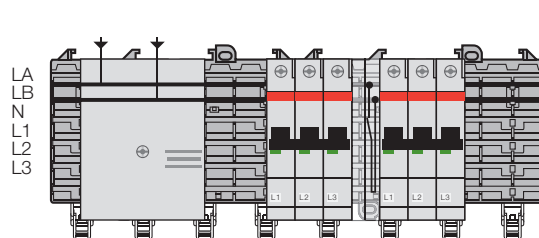

2CCC451027Z0001



Dummy, housing, Neutral disconnecter, shunt trip

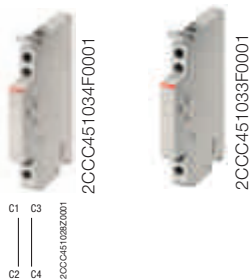

Connection support dummy housing

for left or right side mounting on MCB S400, RCCB F402, RCCB F404, RCBO FS401

Connection support	Type name	ABB IT number	EAN number	Pack-aging unit	Module	Weight in grams
	AS400	2CCS500900R0151	010 0958	761 227	10	0.5
						45

Dummy housing

Compensation to 18 mm	ZLS931	2CCS500900R0161	010 0965	10	0.5	35
-----------------------	--------	-----------------	----------	----	-----	----



Contacting pieces for auxiliary switch and signal contacts

Contacting piece for HK/SK LA, LB	ZLS632	2CCS500900R0171	010 0972	Pack contains 100 items	-	200
Contacting piece for HK/SK LA, LB	ZLS635	2CC5201307R0171	010 9265	Pack contains 10 items	-	20
Contact Pin	ZLS633	2CCS500900R0201	010 8640	Pack contains 10 items		



Neutral disconnecter

On the load side terminal two separate conductors can be clamped

Neutral disconnecter 9 mm	NT401 63	2CCS500900R0021	010 0859	10	0.5	45
Neutral disconnecter 18 mm	NT402 63	2CCS500900R0011	010 0842	10	1	58
Compensation to 18 mm for NT401 63	ZLS728	2CCS400900R0101	010 4710	1	0.5	15
				Bag contains 5 items		



Shunt trip

Function: remote opening of the device when a voltage is applied. Suitable for MCBs S400 series.

Rated voltage	Type name	ABB IT number	EAN number	Pack-aging unit	Module	Weight in grams
12–60 VAC/DC	S 2C-A1	2CDS 200 909 R0001	257 0992	801 254	1	1
110–415 VAC/DC, 110–250 VDC	S 2C-A2	2CDS 200 908 R0002	257 1005		1	1

Orders for this two types can be done over DESTO

F4C-ARI motor operating devices

Order codes, dimensions



2CCC451492F0001

Motor operating devices for residual current circuit breakers F404 25 ... 63 A

Supply voltage 12 ... 30 VAC; 12 ... 48 VDC

1 integrated auxiliary contact

Type name	ABB IT number	EAN number	Packaging unit	Modul	Weight in grams
F4C-CM	2CSF204986R0013	8012542998730	1	2	166

For Supply voltage 230V it is needed to use a safety transformer TS16/12 (2CSM161401R401R0811).

Motor operating auto-reclosing unit for residual current circuit breakers F404 25 ... 63A

Supply voltage 12 ... 30 VAC; 12 ... 48 VDC

1 integrated auxiliary contact

Type name	ABB IT number	EAN number	Packaging unit	Modul	Weight in grams
F4C-ARI	2CSF204987R0013	8012542998631	1	2	166

For Supply voltage 230V it is needed to use a safety transformer TS16/12 (2CSM161401R401R0811).

Safety transformer

Type name	ABB IT number	EAN number	Packaging unit	Weight in grams
TS16/12	2CSM161401R0811	8012542368908	1	355

Starter pack



40277

Starter pack

Contains socket bases with 3 or 4 main busbars already inserted as required and two end pieces.

Solutions available	Busbar length incl. socket end piece mm	Busbar length mm	Type name	ABB IT number	EAN number 761227	Pack-aging unit	Weight in grams
20 PLE 3L	401	357	ZLS204E20-3L	2CCA180637R0001	0109104	1	542
20 PLE 3LN	401	357	ZLS204E20-3LN	2CCA189128R0001	0109128	1	618
22 PLE 3L	437	393	ZLS204E22-3L	2CCF016420R0001	0051007	1	596
22 PLE 3LN	437	393	ZLS204E22-3LN	2CCF016421R0001	0051014	1	679
24 PLE 3L	473	429	ZLS204E24-3L	2CCF015436R0001	0021574	1	650
24 PLE 3LN	473	429	ZLS204E24-3LN	2CCF015347R0001	0021581	1	741
26 PLE 3L	509	465	ZLS204E26-3L	2CCA180639R0001	0109210	1	704
26 PLE 3LN	509	465	ZLS204E26-3LN	2CCA180642R0002	0109227	1	803
30 PLE 3L	581	537	ZLS204E30-3L	2CCF016422R0001	0051021	1	813
30 PLE 3LN	581	537	ZLS204E30-3LN	2CCF016423R0001	0051038	1	926
32 PLE 3L	617	573	ZLS204E32-3L	2CCF015348R0001	0021598	1	867
32 PLE 3LN	617	573	ZLS204E32-3LN	2CCF015349R0001	0021604	1	988
34 PLE 3L	537	609	ZLS204E34-3L	2CCF017609R0001	0109111	1	921
34 PLE 3LN	537	609	ZLS204E34-3LN	2CCF017620R0001	0108046	1	1050
36 PLE 3L	689	645	ZLS204E36-3L	2CCF407230R0001	1407230	1	975
36 PLE 3LN	689	645	ZLS204E36-3LN	2CCF407247R0001	1407247	1	1110
38 PLE 3L	725	681	ZLS204E38-3L	2CCF016424R0001	0051045	1	1029
38 PLE 3LN	725	681	ZLS204E38-3LN	2CCF016425R0001	0051052	1	1173
40 PLE 3L	761	717	ZLS204E40-3L	2CCF015350R0001	0021611	1	1084
40 PLE 3LN	761	717	ZLS204E40-3LN	2CCF015351R0001	0021628	1	1235
44 PLE 3L	833	789	ZLS204E44-3L	2CCF017621R0001	0108053	1	1192
44 PLE 3LN	833	789	ZLS204E44-3LN	2CCF017622R0001	0108060	1	1359
46 PLE 3L	869	825	ZLS204E46-3L	2CCA181086R0001	1409616	1	1250
46 PLE 3LN	869	825	ZLS204E46-3LN	2CCA181087R0001	1409623	1	1422
48 PLE 3L	905	861	ZLS204E48-3L	2CCF015352R0001	0021635	1	1300
48 PLE 3LN	905	861	ZLS204E48-3LN	2CCF015353R0001	0021642	1	1482
52 PLE 3L	977	977	ZLS204E52-3L	2CCF181080R0001	1401313	1	1410
52 PLE 3LN	977	977	ZLS204E52-3LN	2CCF181081R0001	1401320	1	1605
58 PLE 3L	1058	1058	ZLS204E58-3L	2CCF181090R0001	1411909	1	1580
58 PLE 3LN	1058	1058	ZLS204E58-3LN	2CCF181091R0001	1411916	1	1795
62 PLE 3L	1158	1114	ZLS204E62-3L	2CCF180630R0001	0108084	1	1680
62 PLE 3LN	1158	1114	ZLS204E62-3LN	2CCF180631R0001	0108091	1	1914
64 PLE 3L	1194	1150	ZLS204E64-3L	2CCF016246R0001	0051069	1	1734
64 PLE 3LN	1194	1150	ZLS204E64-3LN	2CCF016247R0001	0051076	1	1976
72 PLE 3L	1338	1294	ZLS204E72-3L	2CCA181088R0001	1409630	1	2224
72 PLE 3LN	1338	1294	ZLS204E72-3LN	2CCA181089R0001	1409647	1	1335
80 PLE 3L	1482	1438	ZLS204E80-3L	2CCF015354R0001	0021659	1	2167
80 PLE 3LN	1482	1438	ZLS204E80-3LN	2CCF015355R0001	0021666	1	2470

Sockets



2CCC451038F0001

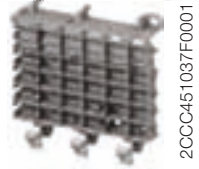

2CCC451037F0001



2CCC451119F0001



2CCC451039F0001

Socket base

	Type name	ABB IT number	EAN number	Pack-aging unit	Module	Weight in grams
8-module socket Length 144 mm	ZLS808	2CCA180160R0001	002 1796	10	8	80
6-module socket Length 108 mm	ZLS806	2CCA180161R0001	002 1789	10	6	60

Busbars for the sockets

	Type name	ABB IT number	EAN number	Pack-aging unit	Module	Weight in grams
100 A busbar plated, 10x3 mm, for L1, L2, L3, N and PE – Delivery length 1979 mm	ZLS200	2CCF002772R0001	001 5702	10	110	640
40 A auxiliary busbar plated, 5x2 mm, for LA und LB – Delivery length 1979 mm	ZLS202	2CCF002773R0001	001 5719	10	110	240

Socket end piece

	Type name	ABB IT number-	EAN number	Pack-aging unit	Module	Weight in grams
To prevent displacement of sockets and busbars	ZLS730	2CCA180702R0001	052 3535	1	– (2 pieces, left and right)	70

Additional socket, terminals

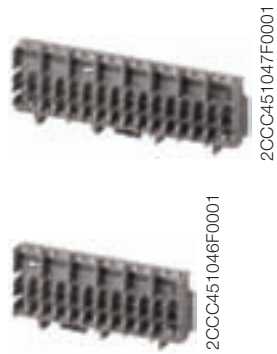

Additional socket

The additional socket can easily be fitted onto the socket base to accommodate the external N and/or PE busbars. This enables neutral connections to be made where single-pole miniature circuit breakers are used with unswitched neutral. Neutral terminals are clipped onto the additional socket and can be used as detachable neutral connections. One N busbar and/or one PE busbar can be fitted. Each socket base can be equipped with an additional socket. Because it contains an integrated 35 mm DIN-rail snap-on feature, the external N or PE busbars can be fitted anywhere in the distribution panel, even separately from the system. The additional sockets can be covered to prevent accidental contact with live parts.

Additional socket for external N and PE busbars

	Type name	ABB IT number	EAN number	Packaging unit	Module	Weight in grams
- 8-module additional socket (suitable for 8-module socket)	ZLS811	2CCF015627R0001	002 1802	10	8	34
- 6-module additional socket (suitable for 6-module socket)	ZLS810	2CCF015628R0001	002 1819	10	6	26

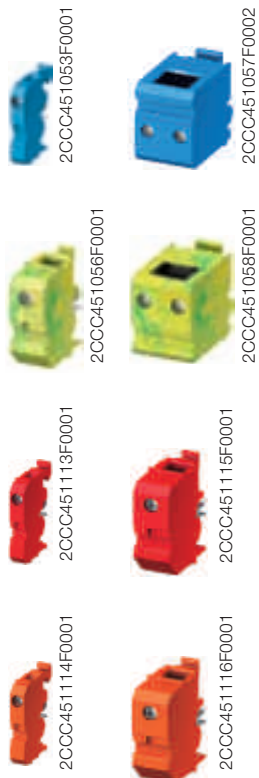

N and PE terminals

Corresponding N terminals (light blue) or PE terminals (yellow-green) are available for the power supply and the outgoing conductors of the external N and PE busbars for cross sections of a wire 1 mm² until 10 mm² (max. 32 A), 16 mm² (max. 63 A), 50 mm² (max. 100 A) and 95 mm² (max. 200 A). The terminals are fitted with label holders which can be used with the marking adapter or the self-adhesive marking label (Phoenix Contact type Cipline UC-TM):

N terminal for additional socket light blue, for external busbars

	Type name	ABB IT number	EAN number	Packaging unit	Module	Weight in grams
- up to 10 mm ²	ZLS812	2CCF015631R0001	002 1840	10	0.5	15
- up to 50 mm ²	ZLS813	2CCF015629R0001	002 1826	10	1	38
- up to 95 mm ² Supply element 200 A	ZLS254	2CCV672504R0001	052 3511	1	2	120

PE terminal for additional socket yellow-green, for external busbars

- up to 10 mm ²	ZLS815	2CCF015632R0001	002 1857	10	0.5	15
- up to 50 mm ²	ZLS816	2CCF015630R0001	002 1833	10	1	38
- up to 95 mm ² Supply element 200 A	ZLS255	2CCV672505R0001	052 3528	1	2	120

Red/orange terminals for additional socket

- up to 10 mm ²	ZLS812/ Red	2CCA181075R0001	010 7971	10	0.5	15
- up to 10 mm ²	ZLS815/ Orange	2CCA181076R0001	010 7995	10	0.5	15
- up to 50 mm ²	ZLS813/ Red	2CCA181065R0001	010 7988	10	1	38
- up to 50 mm ²	ZLS816/ Orange	2CCA181066R0001	010 8008	10	1	38

Additional socket, terminals



2CCC451061F0001

Dummy block

The light grey dummy block fills blank terminal positions. The busbars are at the same time covered against accidental.

Dummy block for additional socket

	Type name	ABB IT number	EAN number	Pack-aging unit	Module	Weight in grams
			761 227			
light grey, fills dummy terminal spaces	ZLS830	2CCF015633R0001	002 1864	10	0.5	6



40436

Cover 144 mm, cover with DIN top 18 mm

Duct cover for additional socket

	Type name	ABB IT number	EAN number	Pack-aging unit	Module	Weight in grams
			761 227			
Duct for covering, Length 144 mm	ZLS833	2CCF015638R0001	002 1895	10	8	20
Cover 18 mm wide with DIN top	ZLS832	2CCF015637R0001	002 1888	10	1	85



40435

Insulator block

The dark grey insulator block isolates the interrupted bus bar ends from one another and simultaneously marks the disconnection point externally.

Insulator block for additional socket

	Type name	ABB IT number	EAN number	Pack-aging unit	Module	Weight in grams
			761 227			
dark grey, for isolation and spacing of the external bus bars	ZLS831	2CCF015634R0001	002 1871	10	0.5	6



2CCC451062F0001

Incoming terminal block and components



2CCC451406F0001

Incoming terminal block 18 mm, 63A 2,5 mm² to 25 mm² max. 1 wire

Type name	ABB IT number	EAN number	Pack-aging unit	Module	Weight in grams
1 contact above 1 contact bottom					
L1, L3 63A	ZLS260	2CCA205305R0001	011 1572	1	90
L2, N 63A	ZLS261	2CCA205306R0001	011 1589	1	90
LA, LB 6A	ZLS262	2CCA205307R0001	011 1596	1	90



2CCC451041100F0001

Incoming terminal component 10 mm² to 95 mm² max. 1 wire

Version	Type name	ABB IT number	EAN number	Pack-aging unit	Module	Weight in grams
761 227						
Feeder component L1	ZLS251	2CCV672501R0001	050 5319	1	2	120
Feeder component L2	ZLS252	2CCV672502R0001	050 5326	1	2	120
Feeder component L3	ZLS253	2CCV672503R0001	050 5333	1	2	120
Feeder component N	ZLS250	2CCV672500R0001	050 5340	1	2	120
Feeder component N	ZLS254	2CCV672504R0001	052 3511	1	2	100
Additional socket						
Feeder component PE	ZLS255	2CCV672505R0001	052 3528	8	2	100
Additional socket						



2CCC451057F0002



2CCC451058100F0001

Incoming terminal blocks 6 mm² to 50 mm² (2 x 25 mm²) + 2 x 10 mm² (LA, LB)

Standard incoming terminal block, complete with main terminals, construction height 50 mm

Type name	ABB IT number	EAN number	Pack-aging unit	Module	Weight in grams
761 227					
50 mm ² (2 x 25 mm ²)					
3LN left	ZLS224	2CCF015196R0001	001 9816	1	180
50 mm ² (2 x 25 mm ²)					
3LN right	ZLS224R	2CCA180152R0001	051 0726	1	180
50 mm ² (2 x 25 mm ²) + 2 x 10 mm ²					
3LNAB (auxiliary busbars)	ZLS224LAB	2CCA180154R0001	005 4251	1	200
50 mm ² (2 x 25 mm ²)					
3L left	ZLS225	2CCF015197R0001	001 9823	1	150
50 mm ² (2 x 25 mm ²)					
3L right	ZLS225R	2CCA180153R0001	051 0733	1	150
50 mm ² (2 x 25 mm ²) + 2 x 10 mm ²					
3LAB (auxiliary busbars)	ZLS225LAB	2CCA180155R0001	005 4220	1	170

Cover for standard incoming terminal block

ZLS235	2CCA180069R0001	002 1543	1	4	37
--------	-----------------	----------	---	---	----

Additional parts for standard incoming terminal block

Auxiliary terminal max. 2 items

10 mm ² (for auxiliary bus bars LA, LB)	ZLS233	2CCF002786R0001	001 9151	2	-	10
N terminal for incom. term. block	ZLS232	2CCF002785R0001	001 9144			30

Incoming terminal block, low, complete with main terminals, construction height 36 mm

50 mm ² (2 x 25 mm ²), 3LN	ZLS228	2CCF015200R0001	001 9854	1	4	180
50 mm ² (2 x 25 mm ²), 3L	ZLS229	2CCF015201R0001	001 9861	1	4	150

Socket accessories



Intermediate piece

Type name	ABB IT number	EAN number	Pack-aging unit	Module	Weight in grams
light grey, fills shock-proof empty module spaces 18 mm – bag containing 5 items	ZLS725	2CCS500900R0181	761 227 010 0989	1	100
Compensation piece to 18 mm for NT 9 mm – bag containing 5 items	ZLS728	2CCS400900R0101	010 4710	1	70



Busbar insulator

dark grey, for isolation and spacing of separate busbar sections, 18 mm	ZLS238	2CCS500900R0191	010 0996	1	20
--	--------	-----------------	----------	---	----



Busbar cover

electrically protected covering of main and auxiliary busbars. The 4 modules cover can be divided. Suitable to accept extension adapter ZLS 101 4x18 mm – bag containing 5 items	ZLS100	2CCF002762R0001	001 5603	1	95
--	--------	-----------------	----------	---	----

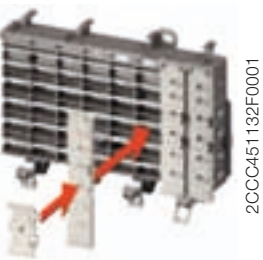

Add-on adapter

18 mm wide, can be plugged on busbar cover ZLS100. To mount conventional DIN devices with 45 mm cap size. – bag containing 10 items	ZLS101	2CCF002763R0001	001 5610	10	2
--	--------	-----------------	----------	----	---



Mounting rail adapter

Height compensation 22.5 mm, to equalize the installation depth of standard DIN-rail mounted devices alongside the SMISLINE plug-in system.	ZLS741	2CCA180081R0001	001 9632	10	3
---	--------	-----------------	----------	----	---

Combi module 32 A (LN), 6 A (LA, LB)

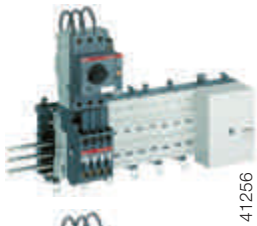

41256



41258



2CCC451059F0001

Top feed



2CCC451060F0001

Bottom feed

Combi module, wire top feed

Designation	Type name	ABB IT number	EAN number	Pack-aging unit	Module	Weight in grams
L1, L2, L3 feed top	ZLS8403LWT-S	2CCA180451R0001	005 4053	761 227	1 3	85
L1, L2, L3 feed top La, Lb	ZLS8403LABWT-S	2CCA180453R0001	005 4091		1 3	95

Combi module, wire bottom feed

L1, L2, L3 bottom feed La, Lb	ZLS8403LABWB-S	2CCA180464R0001	005 4107		1 3	95
-------------------------------	----------------	-----------------	----------	--	-----	----

The following combinations have been tested by the supplier for mechanical stability. ABB contactors can be used with the ABB motor starter if fitted with an appropriate connector. Other combinations cannot be guaranteed by the supplier with regard to mechanical stability.

Designation	With MS325 at the bottom	With MS116 on top
A9	With BEA 16/325 adapter and fixing pin (ZLS522)	With BEA 16/116 adapter and fixing pin (ZLS522)
A12	With BEA 16/325 adapter and fixing pin (ZLS522)	With BEA 16/116 adapter and fixing pin (ZLS522)
A16	With BEA 16/325 adapter and fixing pin (ZLS522)	With BEA 16/116 adapter and fixing pin (ZLS522)
A26	With BEA 26/325 adapter and fixing pin (ZLS522)	With BEA 26/325 adapter and fixing pin (ZLS522)
A9	ABB adapter and fixing pin (ZLS522)	ABB adapter and fixing pin (ZLS522)
A12	ABB adapter and fixing pin (ZLS522)	ABB adapter and fixing pin (ZLS522)
A16	ABB adapter and fixing pin (ZLS522)	ABB adapter and fixing pin (ZLS522)
A26	ABB adapter and fixing pin (ZLS522)	ABB adapter and fixing pin (ZLS522)



2CCC451338F0001

Combi module without plug-in contacts

Designation	Type name	ABB IT number	EAN number	Pack-aging unit	Module	Weight in grams
Combi module	ZLS840	2CCA180450R0001	005 4046	761 227	-	45

Combi module accessories

Connection element for combi module (3 connectors per module)	ZLS519	2CCA017429R0001	005 4268	1	-	-
Bag containing 12 items						
Fixing pins for contactor and manual motor starter	ZLS518	2CCF002792R0001	001 9465	1	-	20
Bag containing 10 items						
Fixing pins for contactor ABB A9, A12, A16, A26, AL9, AL12, AL16, AL26	ZLS522	2CCF017540R0001	010 0743	1	-	30
Bag containing 10 items						

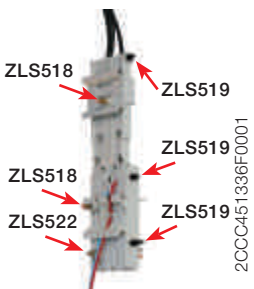

2CCC451336F0001

32 A and 63 A universal adapters



20CC451043F0001



20CC451042F0001

32 A and 63 A universal adapters

Designation	Type name	ABB IT number	EAN number	Pack-aging unit	Module	Weight in grams
			761 227			
Single adapter 32 A, bottom feed						
L1	ZLS161	2CCA180660R0001	050 5609	1	1	18
L2	ZLS162	2CCA180661R0001	050 5616	1	1	18
L3	ZLS163	2CCA180662R0001	050 5623	1	1	18
N	ZLS160	2CCA180663R0001	050 5593	1	1	18
Adapter, dummy element	ZLS164	2CCA180668R0001	050 5548	1	1	12
Single adapter 63 A, bottom feed						
L1	ZLS171	2CCA180652R0001	050 5517	1	1	20
L2	ZLS172	2CCA180653R0001	050 5524	1	1	20
L3	ZLS173	2CCA180654R0001	050 5531	1	1	20
N	ZLS170	2CCA180655R0001	050 5500	1	1	20
Adapter, dummy element	ZLS164	2CCA180668R0001	050 5548	1	1	12
Single adapter 32 A, top feed						
L1	ZLS177	2CCA180664R0001	050 5562	1	1	18
L2	ZLS178	2CCA180665R0001	050 5579	1	1	18
L3	ZLS179	2CCA180666R0001	050 5586	1	1	18
N	ZLS176	2CCA180667R0001	050 5555	1	1	18
Single adapter 63 A, top feed						
L1	ZLS167	2CCA180656R0001	050 5647	1	1	20
L2	ZLS168	2CCA180657R0001	050 5654	1	1	20
L3	ZLS169	2CCA180658R0001	050 5661	1	1	20
N	ZLS166	2CCA180659R0001	050 5630	1	1	20
Combination 32 A, bottom feed						
L1, N	ZLS180	2CCA180970R0001	052 3399	1	2	40
L2, N	ZLS181	2CCA180971R0001	052 3405	1	2	40
L3, N	ZLS182	2CCA180972R0001	052 3412	1	2	40
L1, L2, L3	ZLS183	2CCA180973R0001	052 3429	1	3	60
L1, L2, L3, N	ZLS184	2CCA180974R0001	052 3436	1	4	80
Combination 63 A, bottom feed						
L1, N	ZLS186	2CCA180975R0001	052 3443	1	2	40
L2, N	ZLS187	2CCA180976R0001	052 3450	1	2	40
L3, N	ZLS188	2CCA180977R0001	052 3467	1	2	40
L1, L2, L3	ZLS189	2CCA180978R0001	052 3474	1	3	60
L1, L2, L3, N	ZLS190	2CCA180979R0001	052 3481	1	4	80
Combination 32 A, top feed						
L1, N	ZLS191	2CCA181629R0001	051 0665	1	2	36
L2, N	ZLS192	2CCA181630R0001	051 0672	1	2	36
L3, N	ZLS193	2CCA181631R0001	051 0689	1	2	36
L1, L2, L3	ZLS194	2CCA181632R0001	051 0696	1	3	54
L1, L2, L3, N	ZLS195	2CCA181633R0001	051 0702	1	4	72



20CC451044F0001



20CC451045F0001

32 A and 63 A universal adapters, miscellaneous accessories

32 A and 63 A universal adapters

Designation	Type name	ABB IT number	EAN number	Packaging unit	Module	Weight in grams
Single adapter, wire length 300 mm, 32 A top feed						
N	ZLS176L300	2CCA181657R0001	010 0767	1	1	35
L1	ZLS177L300	2CCA181656R0001	010 0774	1	1	35
L2	ZLS178L300	2CCA181655R0001	010 0781	1	1	35
L3	ZLS179L300	2CCA181654R0001	010 0798	1	1	35
Single adapter, wire length 300 mm, 63 A bottom feed						
N	ZLS170L300	2CCA181612R0001	051 0788	1	1	35
L1	ZLS171L300	2CCA181613R0001	051 0795	1	1	35
L2	ZLS172L300	2CCA181614R0001	051 0801	1	1	35
L3	ZLS173L300	2CCA181615R0001	051 0818	1	1	35
Single adapter, wire length 300 mm, 32 A bottom feed						
N	ZLS160L300	2CCA181653R0001	010 0804	1	1	35
L1	ZLS161L300	2CCA181652R0001	010 0811	1	1	35
L2	ZLS162L300	2CCA181651R0001	010 0828	1	1	35
L3	ZLS163L300	2CCA181650R0001	010 0835	1	1	35
Single adapter, wire length 300 mm, 63 A top feed						
N	ZLS166L300	2CCA181608R0001	051 0740	1	1	35
L1	ZLS167L300	2CCA181609R0001	051 0757	1	1	35
L2	ZLS168L300	2CCA181610R0001	051 0764	1	1	35
L3	ZLS169L300	2CCA181611R0001	051 0771	1	1	35
			EAN number			
			762 227			
Connection set for	ZLS174	2CCA180671R0001	052 3382	1		–
Multi-pole adapter (Bag containing 100 items for 50 adapters)						

Identification system ILS

The individual identification system for ILS inscription panels is a DIN A5 polyester film for inkjet and laser printers with resistance to high temperatures (if laser printers are used, please check whether self-adhesive films with a thickness of 250 microns can be printed). They can also be inscribed by hand using ink, biro, pencil or felt tip.

	Type name	ABB IT number	EAN number	Packaging unit	Module	Weight in grams
			761 227			
For Laserprinter	ZLS418	2CCS400900R0211	010 4826	1 sheet	–	–
For Inkjet	ZLS419	2CCS400900R0291	010 8800	1 sheet	–	–

Locking device

Padlock adapter 3 mm	SA 1	GJF1101903R0001	010 4833	1	–	23
– Bag containing 10 items						
Padlock	SA 2	GJF1101903R0002	010 4857	1	–	20



Busbars 40 A and 100 A

40 A and 100 A busbars / selection table for sockets

Order data busbar 100 A	ABB IT number	EAN number 761227	ZLS808	ZLS806	Pack- aging unit	Length incl. end piece	Busbar length in mm	Order date busbar 40 A	ABB IT number	EAN number 761227
ZLS201E6	2CCF800158R0001	0016778	-	1	6	148	104	ZLS203E6	2CCF800218R0001	0017966
ZLS201E8	2CCF800159R0001	0016983	1	-	8	186	140	ZLS203E8	2CCF800219R0001	0018178
ZLS201E12	2CCF800160R0001	0016211	-	2	12	256	212	ZLS203E12	2CCF800220R0001	0017409
ZLS201E14	2CCF800161R0001	0016310	1	1	14	292	248	ZLS203E14	2CCF800221R0001	0017508
ZLS201E16	2CCF800162R0001	0016334	2	-	16	328	284	ZLS203E16	2CCF800222R0001	0017522
ZLS201E18	2CCF800163R0001	0016358	-	3	18	364	320	ZLS203E18	2CCF800223R0001	0017546
ZLS201E20	2CCF800164R0001	0016372	1	2	20	401	357	ZLS203E20	2CCF800224R0001	0017560
ZLS201E22	2CCF800165R0001	0016396	2	1	22	437	393	ZLS203E22	2CCF800225R0001	0017584
ZLS201E24	2CCF800166R0001	0016419	3	-	24	473	429	ZLS203E24	2CCF800226R0001	0017607
ZLS201E26	2CCF800167R0001	0016433	1	3	26	509	465	ZLS203E26	2CCF800227R0001	0017621
ZLS201E28	2CCF800168R0001	0016457	2	2	28	545	501	ZLS203E28	2CCF800228R0001	0017645
ZLS201E30	2CCF800169R0001	0016471	3	1	30	581	537	ZLS203E30	2CCF800229R0001	0017669
ZLS201E32	2CCF800170R0001	0016495	4	-	32	617	573	ZLS203E32	2CCF800230R0001	0017683
ZLS201E34	2CCF800171R0001	0016518	2	3	34	653	609	ZLS203E34	2CCF800231R0001	0017706
ZLS201E36	2CCF800172R0001	0016532	3	2	36	689	645	ZLS203E36	2CCF800232R0001	0017720
ZLS201E38	2CCF800173R0001	0016556	4	1	38	725	681	ZLS203E38	2CCF800233R0001	0017744
ZLS201E40	2CCF800174R0001	0016570	5	-	40	761	717	ZLS203E40	2CCF800234R0001	0017768
ZLS201E42	2CCF800175R0001	0016594	3	3	42	797	753	ZLS203E42	2CCF800235R0001	0017782
ZLS201E44	2CCF800176R0001	0016617	4	2	44	833	789	ZLS203E44	2CCF800236R0001	0017805
ZLS201E46	2CCF800177R0001	0016631	5	1	46	869	825	ZLS203E46	2CCF800237R0001	0017829
ZLS201E48	2CCF800178R0001	0016655	6	-	48	905	861	ZLS203E48	2CCF800238R0001	0017843
ZLS201E50	2CCF800179R0001	0016679	4	3	50	941	897	ZLS203E50	2CCF800239R0001	0017867
ZLS201E52	2CCF800180R0001	0016693	5	2	52	977	933	ZLS203E52	2CCF800240R0001	0017881
ZLS201E54	2CCF800181R0001	0016716	6	1	54	1013	969	ZLS203E54	2CCF800241R0001	0017904
ZLS201E56	2CCF800182R0001	0016730	7	-	56	1049	1005	ZLS203E56	2CCF800242R0001	0017928
ZLS201E58	2CCF800183R0001	0016754	5	3	58	1085	1041	ZLS203E58	2CCF800243R0001	0017942
ZLS201E60	2CCF800184R0001	0016785	6	2	60	1122	1078	ZLS203E60	2CCF800244R0001	0017973
ZLS201E62	2CCF800185R0001	0016808	7	1	62	1158	1114	ZLS203E62	2CCF800245R0001	0017997
ZLS201E64	2CCF800186R0001	0016822	8	-	64	1194	1150	ZLS203E64	2CCF800246R0001	0018017
ZLS201E66	2CCF800187R0001	0016846	6	3	66	1230	1186	ZLS203E66	2CCF800247R0001	0018031
ZLS201E68	2CCF800188R0001	0016860	7	2	68	1266	1222	ZLS203E68	2CCF800248R0001	0018055
ZLS201E70	2CCF800189R0001	0016884	8	1	70	1302	1258	ZLS203E70	2CCF800249R0001	0018079
ZLS201E72	2CCF800190R0001	0016907	9	-	72	1338	1294	ZLS203E72	2CCF800250R0001	0018093
ZLS201E74	2CCF800191R0001	0016921	7	3	74	1374	1330	ZLS203E74	2CCF800251R0001	0018116
ZLS201E76	2CCF800192R0001	0016945	8	2	76	1410	1366	ZLS203E76	2CCF800252R0001	0018130
ZLS201E78	2CCF800193R0001	0016969	9	1	78	1446	1402	ZLS203E78	2CCF800253R0001	0018154
ZLS201E80	2CCF800194R0001	0016990	10	-	80	1482	1438	ZLS203E80	2CCF800254R0001	0018185
ZLS201E82	2CCF800195R0001	0017010	8	3	82	1518	1474	ZLS203E82	2CCF800255R0001	0018208
ZLS201E84	2CCF800196R0001	0017034	9	2	84	1554	1510	ZLS203E84	2CCF800256R0001	0018222
ZLS201E86	2CCF800197R0001	0017058	10	1	86	1590	1546	ZLS203E86	2CCF800257R0001	0018246
ZLS201E88	2CCF800198R0001	0017072	11	-	88	1626	1582	ZLS203E88	2CCF800258R0001	0018260
ZLS201E90	2CCF800199R0001	0017096	9	3	90	1662	1618	ZLS203E90	2CCF800259R0001	0018284
ZLS201E92	2CCF800200R0001	0017119	10	2	92	1698	1654	ZLS203E92	2CCF800260R0001	0018307
ZLS201E94	2CCF800201R0001	0017133	11	1	94	1734	1690	ZLS203E94	2CCF800261R0001	0018321
ZLS201E96	2CCF800202R0001	0017157	12	-	96	1770	1726	ZLS203E96	2CCF800262R0001	0018345
ZLS201E98	2CCF800203R0001	0017171	10	3	98	1806	1762	ZLS203E98	2CCF800263R0001	0018369
ZLS201E100	2CCF800204R0001	0016006	11	2	100	1843	1799	ZLS203E100	2CCF800264R0001	0017195
ZLS201E102	2CCF800205R0001	0016020	12	1	102	1879	1835	ZLS203E102	2CCF800265R0001	0017218
ZLS201E104	2CCF800206R0001	0016044	13	-	104	1915	1871	ZLS203E104	2CCF800266R0001	0017232
ZLS201E106	2CCF800207R0001	0016068	11	3	106	1951	1907	ZLS203E106	2CCF800267R0001	0017256
ZLS201E108	2CCF800208R0001	0016082	12	2	108	1987	1943	ZLS203E108	2CCF800268R0001	0017270

Planning for the incorporation of feeder block and spare places should be taken into account.
The total lengths given above were calculated taking socket spacings and tolerances into account.
For this reason, the indicated busbar length is not necessarily a multiple of 18 mm (1 Module).

Table of contents

Technical data

Busbar system

Overview devices with a busbar system	2/2
Socket/additional socket/busbars	2/4
Incoming terminal block/Incoming terminal components	2/6
Power supply	2/8
Busbar system accessories	2/10
Definitions	2/11
Technical data overview	2/12

Miniature circuit breaker S400

Technical data overview	2/13–14
Trip characteristics applications	2/15
Trip characteristics, trip behaviour	2/16
Diagram of let through energy I^2t	2/18
Power Supply: Overload and short circuit protection	2/19
Technical data: back-up and selectivity	2/20
Back-up protection with fuses, S800 and Tmax	2/21
Selectivity to fuses	2/22
Selectivity to S800 S	2/23–24
Selectivity to S800 N	2/24–26
Selectivity to Tmax	2/27–33
Influence of ambient temperature	2/34–35
Protection of circuits with fluorescent lamps,	2/36
DC applications with S400M	
DC applications with S400UC	2/37

Residual current operated circuit breaker F404, F402

Properties, Technical data	2/38–43
----------------------------	---------

Residual current operated circuit (RCBO) breaker FS401, FS403

Properties, Technical data	2/44–45
----------------------------	---------

High performance motor starter MS325

Technical data overview	2/46
Rated breaking capacity, back-up protection	2/47

Switch disconnecter IS404

Description, Technical data overview	2/49
--------------------------------------	------

Overcurrent arrester OVR404

Technical data overview	2/50–52
Auxiliary switches and signal contacts	2/53
Accessory mounting options	2/54
Auxiliary switches and signal contacts wiring variants	2/55
Auxiliary switches and signal contacts	2/56
Left/right mounting	

Shunt trip für S400

Technical data	2/57
Motor operating devices for S404	2/57–61

Overview devices with a busbar system

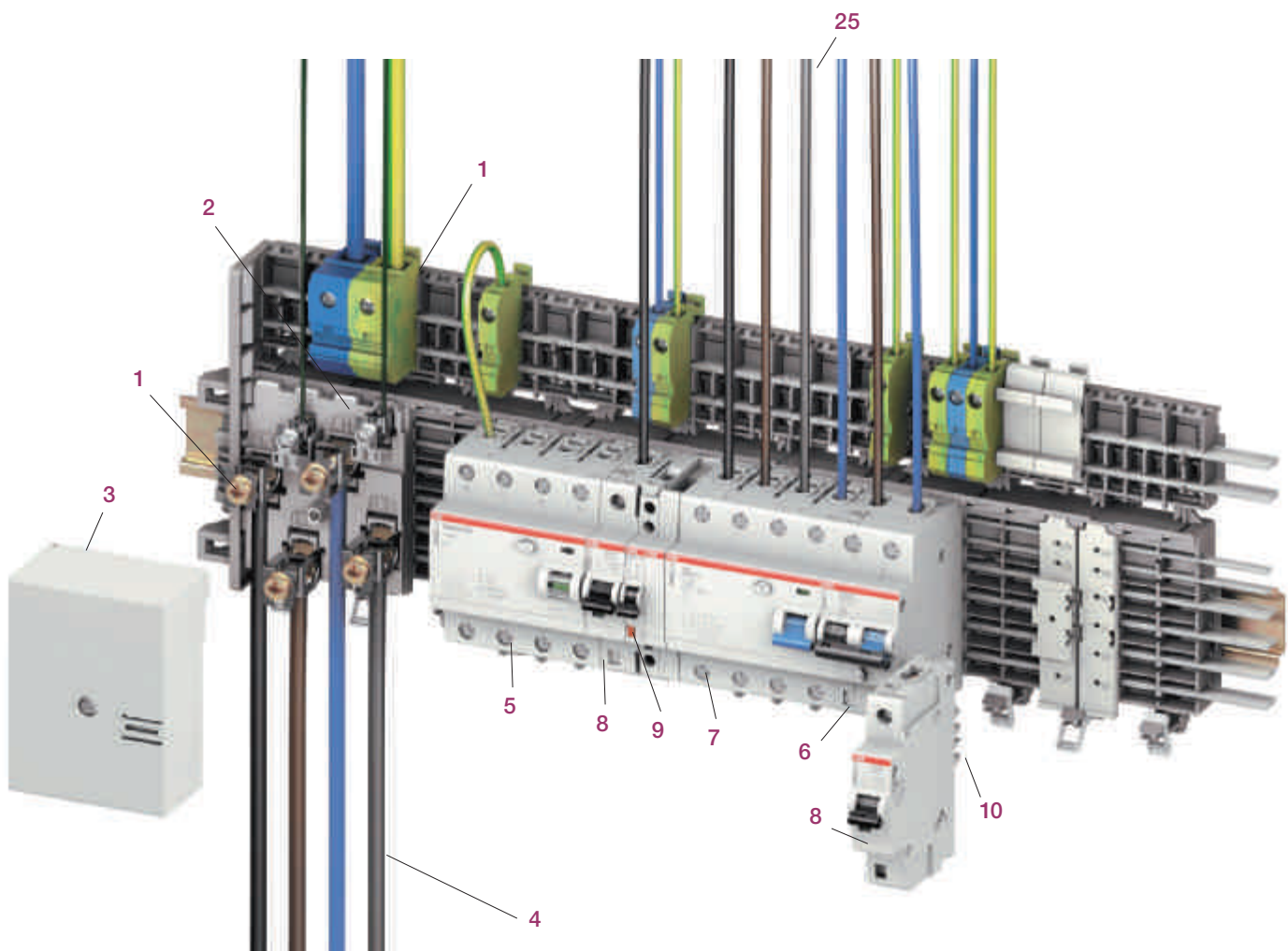

2CCC451256F0001

- | | |
|--|---|
| <p>1 Supply terminal</p> <p>2 Incoming terminal block with a max. current rating of 160A 50 mm² (2 x 25 mm²) + 2 x 10 mm² (LA, LB)</p> <p>3 Cover for incoming terminal block</p> <p>4 Supply cable</p> <p>5 Surge arrester OVR404</p> <p>6 RCBO FS401</p> <p>7 Residual-current circuit breaker F404</p> <p>8 Miniature circuit breaker S401 M</p> <p>9 Signal contact</p> <p>10 Plug contacts</p> <p>11 DIN adapter</p> <p>12 Spare way cover</p> | <p>13 Device latch</p> <p>14 Busbar L3 or DC +, -</p> <p>15 Busbar L2 or DC +, -</p> <p>16 Busbar L1 or DC +, -</p> <p>17 Busbar N</p> <p>18 Sockets, 8-module and 6-module</p> <p>19 Auxiliary busbar LA</p> <p>20 Auxiliary busbar LB</p> <p>21 Busbar N, external</p> <p>22 Busbar PE, external</p> <p>23 Additional socket</p> <p>24 N and PE terminals 32 A 1 mm² to 10 mm², 63A 16 mm² to 50 mm² and 100A 16 mm² to 95 mm², red and orange terminals for DC</p> |
|--|---|

Overview of busbar system

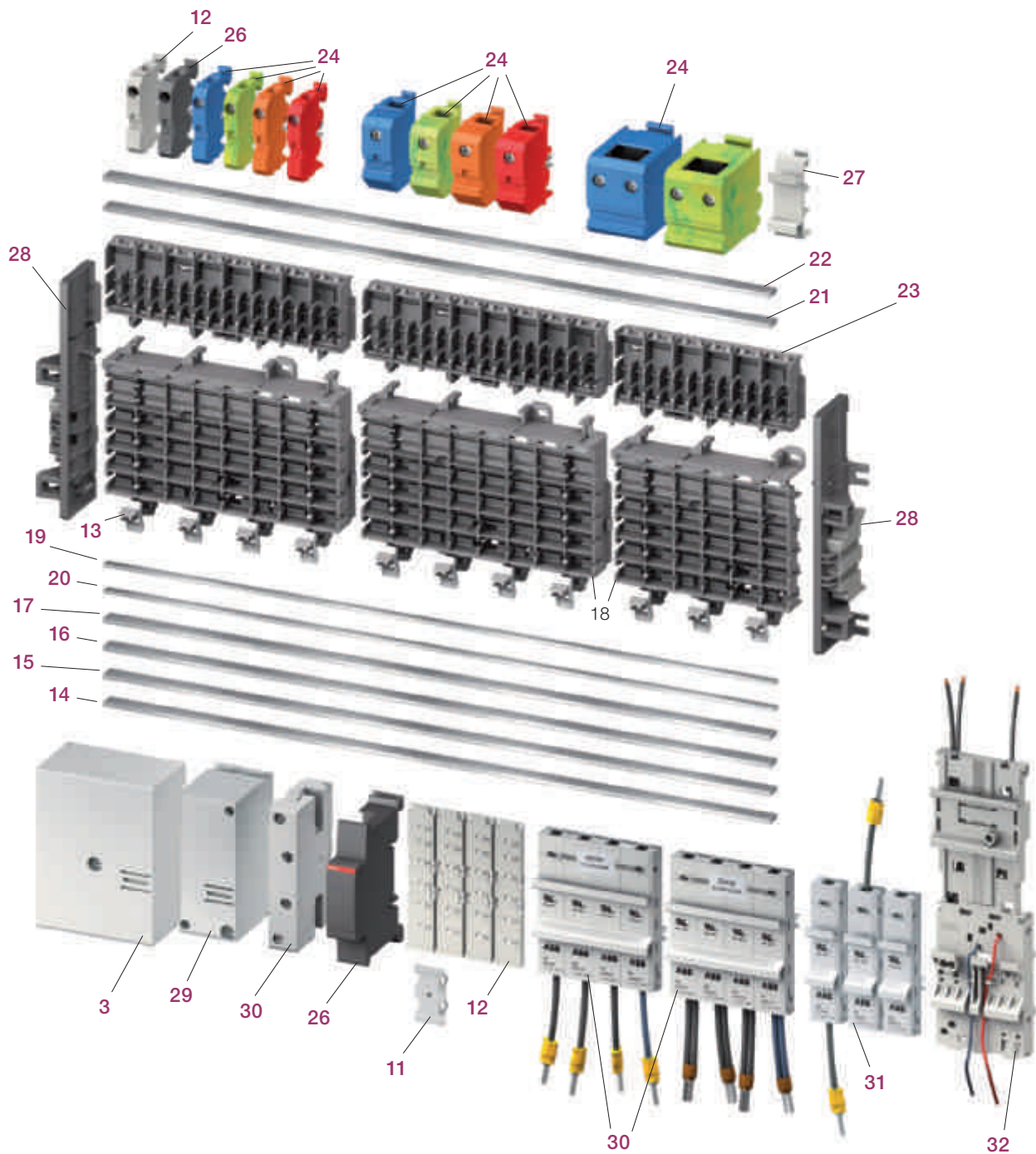

- 25 Output circuits
- 26 Busbar isolator
- 27 Dummy block an 18 mm cover with DIN top for the additional socket
- 28 Socket end piece on left and right
- 29 Incoming terminal component, centre power supply 200 A, maximum 95 mm²
- 30 Universal adapter with a current rating of 32 A, 63 A or 100 A
- 31 Combi module with a current rating of 32 A
- 32 Incoming terminal block, 63 A, maximum 25 mm²

Socket/additional socket/busbars

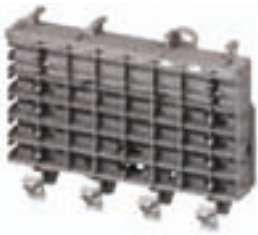

2CCC451038F0001



2CCC451037F0001

Socket bases ZLS808, ZLS806

The SMISLINE socket system is a totally new kind of assembly and connection technology for the construction of distributions. Besides the classic method of snapping the devices onto 35-mm mounting rails, the new family of devices can be directly attached to the socket bases with integrated busbars. The time-consuming process of connecting up the supply is thereby no longer needed. In addition, in the event of rearrangement or expansion, the replacement of devices in existing systems is made significantly easier.

The socket sections and the wide range of accessories make it possible to plan with the capability for expansion and to construct distribution systems of any desired size in a short period of time.

6- and 8-module sockets are installed either by screwing them onto any flat surface or by snapping them onto a 35 mm DIN mounting rail. Lateral movement or detachment of the sockets again is possible before final fixing.

In order to determine the required socket length, the space necessary for

- the devices required
- the incoming terminal block and
- any reserve spaces needed must be determined.

Snap mounting

Pull down the slide with a screwdriver until it latches (socket can be moved).

Press on front of slid:

Fixed position

(Sockets fixed)



40771



40772



The key features

- System of any desired length (even number of poles)
- Integrated busbars
- Simple device change
- Long-term planning and problem free extension possible
- Significant time savings during assembly and connection

Additional sockets ZLS808, ZLS806

The additional socket can easily be fitted onto the socket base to accommodate the external N and/or PE busbars. This enables neutral connections to be made where single-pole miniature circuit breakers are used with unswitched neutral. Neutral terminals are clipped onto the additional socket and can be used as detachable neutral connections. One N busbar and/or one PE busbar can be fitted. Each socket base can be equipped with an additional socket. Because it contains an integrated 35 mm DIN-rail snap-on feature, the external N or PE busbars can be fitted anywhere in the distribution panel, even separately from the system. The additional sockets can be covered to prevent accidental contact with live parts.



2CCC451046F0001



2CCC451047F0001



2CCC45119F0001

Busbars for the sockets and additional socket ZLS200

The busbars of size 10x3 mm can be loaded with currents up to 100 A. They are plated for perfect contact with the devices plug-in contacts. The maximum available busbar length is 1979 mm. The same busbar type is used, regardless whether it is fitted in the socket (L1, L2, L3, N) or in the additional socket (N, PE). The busbars are inserted in to the socket from the front.

Auxiliary busbars for the socket ZLS202

The 5x2 mm auxiliary busbars are intended for a common power supply of auxiliary switches and signal contacts. They are also plated and their max. delivery length is 1979 mm.

Like the main busbars, the auxiliary busbars are inserted in holders LA and LB from the front. Of course, only one auxiliary busbar can be fitted.

Incoming terminal block/Incoming terminal components

General

The incoming terminal block is used to connect cables directly to the busbars. The terminals act directly on the busbars and therefore fix the incoming terminal block. Removable terminal tops permit the connection of continuous conductors (risers) while horizontal or vertical cable entry is also possible.

Instead of using the incoming terminal block, the power supply can also be realized via a device (e.g. residual current operated circuit breaker, miniature circuit breaker or switch disconnector).

Power supply left or right, maximum 100 A.



451078F00012CCC



2CCC451077F0001



2CCC451117F0001

Power supply in centre, maximum 160 A.

A maximum of 100 A is permitted on either side. A total of 160 A must not be exceeded.

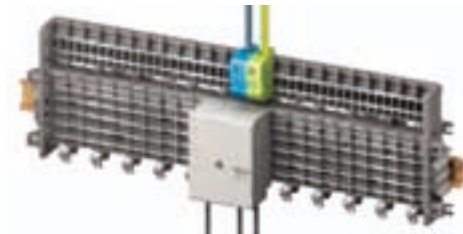

2CCC451081F0001



2CCC451354F0001

Incoming maximum 63 A

Incoming terminal blocks ZLS224, 225

A standard incoming terminal block whose cover provides protection against accidental contact. Construction height 50 mm. The base plate can be fitted with a maximum of 4 main terminals L1, L2, L3 and N for the busbars, and 2 auxiliary terminals LA and LB for the auxiliary busbars.

Incoming terminal blocks, low ZLS228, 229

Incoming terminal block with construction height of 36 mm.



2CCC451073F0001



2CCC451406F0001



2CCC451407F0001

Incoming terminal blocks ZLS260 to 262

Compact terminal block with the construction width of 18 mm for 2 poles. The maximum rated current is 63 A for L1, L2, L3N and 6 A for LA, LB.



451041F0001

Incoming terminal component ZLS250 to 255

The incoming terminal component, with an installation width of 36 mm is available as a single-pole component for the line conductors L1, L2, L3 and as neutral. The terminals act directly on the busbars and thereby fix the incoming terminal component. The incoming terminal component, L1, L2, L3 and N can be combined to meet specific needs. A maximum cable cross-section of 95 mm² can be connected to the incoming terminal component.

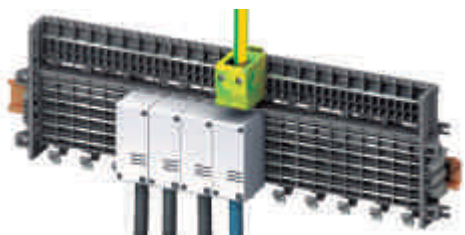

2CCC451082F0002

Incoming terminal component, in centre, maximum 200 A.
But on each side not more than 100 A.

Power supply



2CCC451076F0001

Indirect supply via residual current operated circuit breaker (RCCB) (or switch disconnecter)

The supply cable is connected at the top of the RCCB. This supply variant gives the busbars and therefore all subsequent devices RCCB protection. If several RCCB groups are planned, the busbars should be separated and spaced using the dark grey busbar insulator ZLS238. Attention must then be paid to the regulations governing protection of the residual current circuit breaker by subsequent miniature circuit breakers. The supply can also be fed in through the switch disconnecter.



2CCC451080F0001

Direct supply to residual current operated circuit breaker (or switch disconnecter)

Instead of using the incoming terminal block, the power can also be supplied via a device. In this case, the supply cable is connected to the lower terminal of the device. The residual current operated circuit breaker or switch disconnecter can be supplied with 63 A regardless of its rated current, since the plug-in connection arrangement of the device is suitable for this amount of current. For current in excess of 63 A, the incoming terminal block or the incoming terminal component should be used.



2CCC451208F0001

Supply of busbar system with DC voltage

The busbar system can be supplied using an incoming terminal block or incoming terminal component with DC voltage. The busbars can either be assigned as + or -.



2CCC451078F0001

Supply of external N and PE busbars

External N busbars means, that neutral disconnectors are not needed for the circuit breakers.

When using external N and PE busbars, the neutral or PE conductor is supplied directly to the busbar using a suitable connection terminal. Attention must be paid to appropriate insulation of the N busbar when installing several residual current operated circuit breaker groups.

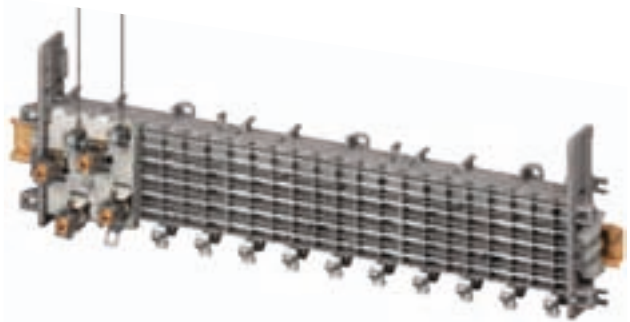

2CCC451079F0001

Supply of auxiliary busbars LA and LB

The two auxiliary busbars LA and LB can be supplied using the additional terminal ZLS 233 via a incoming terminal block. The maximum operating current of the auxiliary busbars is 40 A.

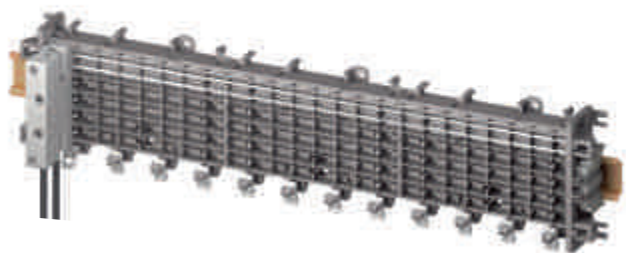

2CCC451355F0001

Incoming block for two auxiliary busbars LA, LB

The pluggable incoming block is especially for the two auxiliary busbars LA, LB. The maximum rated current is 6 A.

Busbar system accessories



Socket end piece ZLS730

To prevent displacement of sockets and busbars (particularly when installed vertically) end pieces can be fitted at the start and finish of each row of sockets. These simultaneously ensure electrically protected covering of the busbar end faces and mechanical fixing of the sockets on the mounting rail.



Intermediate piece ZLS725

The light grey intermediate piece matches the device profile and fills empty module spaces. The busbars are safely covered, so that they cannot be touched and at the same time the corresponding openings in the cover are closed up.



Busbar insulator ZLS238

The dark grey busbar insulator electrically isolates the separated busbar ends from each other (e.g. when using several RCD protected groups) and also identifies the isolation point from outside. It conforms with the device profile and its space requirement is 1 module.



Busbar cover ZLS100

If component modules or spare modules are not required, the busbar cover ensures electrically protected covering of the main and auxiliary busbars. The cover (4 modules) can be divided anywhere. The openings allow voltage measurements on the busbars without removing the cover.

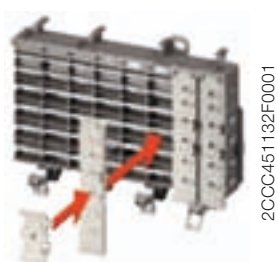

Extension adapter ZLS101

The extension adapter, single or several side by side, can be plugged into the busbar cover via the built-in holding device. This enables conventional DIN devices with 45 mm cap size to be snapped onto the SMISLINE socket. By plugging in several extension adapters one on top of the other, heights can be adjusted in multiples of 7 mm

Definitions

Rated short-circuit breaking capacity I_{cn}

According to EN 60898-1

The maximum current which a switching device can switch off without damage at a rated operational voltage and rated operational frequency. It is specified as an effective value.

Rated ultimate short-circuit breaking capacity I_{cu}

According to EN 60947-2

Ultimate short-circuit breaking capacity that a circuit breaker can switch off without damage at a rated operational voltage and rated operational frequency. It is specified as an effective value.

Rated service short-circuit breaking capacity I_{cs}

According to EN 60947-2

Service short-circuit breaking capacity that a circuit breaker can switch off without damage at a rated operational voltage and rated operational frequency. It is specified as an effective value.

Rated insulation voltage U_i

The rated insulation voltage (U_i) is the voltage to which dielectric checks and creepage distances refer. The maximum rated operational voltage must not exceed its rated insulation voltage.

Rated impulse withstand voltage U_{imp}

Peak of a withstand voltage of a specified form and polarity with which the circuit can be loaded under specified test conditions without a breakdown and to which clearances relate.

The rated impulse withstand voltage must be equal to or greater than the values of the withstand over-voltages (transient over-voltages) which occur in the system in which the device is used.

Rated short-time withstand current I_{cw}

The rated short-time withstand current is the effective value of the short-circuit current, as specified by the manufacturer for this circuit, that the circuit can conduct without damage. Unless otherwise specified, a time of 1 s shall apply.

Rated conditional short-circuit current I_{cc}

The rated conditional short-circuit current is the value of the prospective short-circuit current, as specified by the manufacturer, for a switching device combination that the latter can conduct during the total break time. The information about the specified short-circuit device must be given by the manufacturer.

Rated fused short-circuit current I_{cf}

The rated fused short-circuit current is the conditional rated short-circuit current if the short-circuit device is a fuse in accordance with IEC 60269 [IEV 441-17-21, modified].

Rated peak withstand current I_{pk}

The rated peak withstand current is the peak value of the withstand current of the circuit of a combination of switching devices, as specified by the manufacturer.

Back-up protection

Assignment of two overcurrent protective devices in series, where the protective device, generally but not necessarily on the supply side, effects the overcurrent protection with or without the assistance of the other protective device and prevents excessive stress on the latter [IEC 60947-1, definition 2.5.24].

Total selectivity

Overcurrent discrimination where, in the presence of two overcurrent protective devices in series, the protective device on the load side effects the protection without causing the other protective device to operate [IEC 60947-2, definition 2.17.2].

Partial selectivity

Overcurrent discrimination where, in the presence of two overcurrent protective devices in series, the protective device on the load side effects the protection up to a given level of overcurrent, without causing the other protective device to operate [IEC 60947-2, definition 2.17.3].

Approvals according to IEC/EN 60439-2 and UL

Busbar system

Number of poles:	max. 8 3p+N / 2 additional bars PE+N 2 bars for auxiliary circuits, LA + LB
Rated operational voltage (U _e):	690 VAC, 1000 VDC
Rated insulation voltage (U _i):	690 VAC, 1000 VDC
Rated impulse withstand voltage (U _{imp}):	8 kV
Rated current:	Main circuit: 100 A, mid feeding 160 or 200 A Auxiliary circuit: 40 A
Rated short-time withstand current (I _{cw}):	10 kA/300 ms 10 kA/50 ms for auxiliary circuit
Rated peak withstand current (I _{pk}):	17 kA
Rated fused short-circuit current (I _{cf}):	50 kA, 690 VAC
Rated peak fused short-circuit current (I _{pk}):	105 kA, 690 VAC
SCPD:	S800 High performance MCB 160 A gG DIN 00 with 50 mm ² feeder unit 200 A gG DIN 1 with 95 mm ² feeder unit 40 A gG DIN 00 with 10 mm ² feeder unit 40 A gG DIN 00 for auxiliary circuit (La+Lb)
Rated conditional short-circuit current (I _{cc}):	Main circuit and N+PE additional bars: 32.5kA, 400 VAC
Rated peak short-circuit current (I _{pk}):	68.25 kApk, 400 VAC
Back-up: circuit breaker SACE Tmax 250A	high performance circuit breaker S800, circuit breaker SACE T _{max} 250 A
Protection degree:	IP2X (to be realized by user)
Rated frequency:	50/60
Ambient air temperature:	max. 55 °C
Size of CU bars 3P+N+PE:	3 x 10 mm (30 mm ²)
Size of CU auxiliary bars La Lb:	2 x 5 mm (10 mm ²)
Size of CU additional busbars N+PE:	3 x 10 mm (30 mm ²)

	Maximum rated voltage	Maximum rated current	Borne principale
Incoming terminal block ZLS224/225/228/229	690 VAC 600 VDC	160 A LLLN, 40 A LA, LB	6 mm ² –50 mm ² , 2 x 25 mm ² LLLN, 10 mm ² LA, LB
Incoming terminal block ZLS250–255	690 VAC 600 VDC	200 A	10 mm ² –95 mm ² max. 1 wire
Incoming terminal block ZLS260–262	690 VAC 600 VDC	63 A LLLN, 6 A LA, LB	2 mm ² –25 mm ² LLLN, LA, LB max. 1 wire
Busbar ZLS200	690 VAC 600 VDC	100 A	
Busbar ZLS202	690 VAC 600 VDC	40 A	
Universal adapters 32 A	690 VAC 600 VDC	32 A LLN	
Universal adapters 63 A	690 VAC 600 VDC	63 A LLN	
Combi module	690 VAC 600 VDC	32 A LLN 6A LA, LB	
Terminals for additional socket ZLS812, 815	690 VAC 600 VDC	32 A	10 mm ²
Terminals for additional socket ZLS813, 816	690 VAC 600 VDC	100 A	16 mm ² –50 mm ²

The SMISLINE system and components are tested for vibration according to IEC 60068-2-6 (2–13.2 Hz/1 mm displacement, 13.2–100 Hz/0.7 g) and for Miniature circuit breakers (5 g, 20 frequency cycles 5 ... 150 ... 5 Hz at 0.8 rated current)

Governing standard: IEC 60068-2-6

Environmental testing – Part 2–6: Test Fc. Vibration (sinusoidal)

Technical data according to

	Busbar	Incoming terminal block	Incoming terminal component	Universal adapter	Universal adapter	Combi module
		ZLS224, 224R, 225, 225R	ZLS250, 251, 252, 253	30 A	60 A	
Maximum rated voltage:			600 V	AC		
Maximum rated current:	100 A	150 A	200 A	30 A	60 A	30 A
Rated current for supply, left or right:	100 A	100 A	100 A	–	–	–
Rated current for supply, center:	100 A	150 A	200 A	–	–	–
Resistance to Short circuits:			50 kA	with 200 A back-up fuse		
Supply cable size:		14 + 0, 1/0 AWG	8 AWG, to 3/0 AWG	–	–	–

Miniature circuit breaker

Properties



1
2
2000A/10kA/220V

2000A/10kA/220V



1
2
3
4
2000A/10kA/220V

2000A/10kA/220V



1
2
3
4
5
2000A/10kA/220V

2000A/10kA/220V



1
2
3
4
5
6
7/N
8/N
2000A/10kA/220V

2000A/10kA/220V

General Information

The SMISSLINE miniature circuit-breaker is an energy-restricting circuit-breaker that has high performance values and that is equally suitable for the industrial sector, for commercial use and for installation at home.

If a short-circuit occurs, it guarantees excellent selectivity conditions to upstream overcurrent circuit breakers while the load on equipment that is connected downstream is limited to a minimum amount.

The most important features

- High rated breaking capacity of 10 kA or 6 kA
- Optimum ease of installation and connection
- The pole conductors are protected against accidental contact
- Tripping characteristic on B, C, D, K, UCZ/UCC

Miniature circuit-breaker in accordance with standard EN 60898-1

This standard is for electrical installation material for household installations and for similar purposes. It regulates the use of miniature circuit-breakers by the layman up to a maximum of 125 A, a voltage of 440 VAC and up to a maximum of 25 kA.

Miniature circuit-breaker in accordance with standard EN60947-2

This standard is for low-voltage material used for industrial purposes. It regulates the use of circuit-breakers (and not miniature circuit-breakers) by qualified personnel up to a maximum voltage of 1000 VAC or 1500 VDC. This standard does not recognise any maximum values when it comes to current and breaking capacity. In practice, the standard is also applied to miniature circuit-breakers.

Brief description of tripping

The SMISSLINE miniature circuit breakers have a current-limiting operation. They have two different releases acting on the mechanism.

1. Thermal release, operating with a time delay, for overload protection
2. Electro-magnetic release plunger operated for short-circuit protection.

They offer:

- high short-circuit breaking capacity
- high selectivity to the back-up fuse
- In the event of short-circuits, low electrodynamic and heating effects on the cable and the point of fault location due to the drastically limited let through energy $\int i^2 dt$.

Oscillogram of a short-circuit current interruption

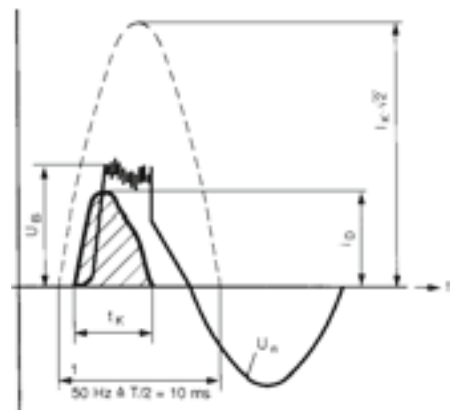

- $i_k \cdot \sqrt{2}$ = peak value of prospective short-circuit current
- i_d = Max. peak let through current of circuit breaker S 400
- U_n = Supply voltage
- U_a = Arc voltage of circuit breaker
- t_k = Total interruption time

2000A/10kA/220V

Miniature circuit breaker

Technical data

	Series: S400 M	Series: S400 M	Series: S400 M-UC
Standard	EN 60898-1	IEC/EN 60947-2	IEC/EN 60947-2
Rated voltage $U_{n\sim}$:	230/400 V~	max. 254/440 V~	230/400 V~
Rated voltage $U_{n=}$:	60 V=/1-pole 125 V=/2-pole	60 V=/1-pole 125 V=/2-pole	125 V=/1-pole 250 V=/2-pole
Max. operating voltage U_{Bmax} :	AC $U_n + 10\%$ DC 1-pole 60 V – 2-pole 125 V –	AC $U_n + 10\%$ DC 1-pole 60 V – 2-pole 125 V –	
Min. operating voltage U_{Bmin} :	12 V~, 12 V-	12 V~, 12 V-	
Rated current I_n :	6...63 A (B, D) 0.5...63 A (K, C)	0.5...63 A	
Trip characteristics:	B, C, D	C, K	C Z (Semi-conductor protection)
Number of poles:	1...4	1...4	1+2
Rated frequency f_n :	50/60 Hz (16 ^{2/3} Hz on request)	50/60 Hz (16 ^{2/3} Hz on request)	
Rated breaking capacity I_{cn} :	6 kA (S400/450... E) 10 kA (S400/450... M)		DC 50 kA \leq 2 A τ 5 ms DC 10 kA $>$ 2 A... \leq 63 A τ 15 ms AC 25 kA \leq 2 A AC 4.5 kA $>$ 3 A... \leq 25 A AC 3 kA $>$ 32 A... \leq 63 A
Ultimate breaking capacity I_{cu} at 230/400 V~		50 kA \leq 2 A 25 kA $>$ 2 A... \leq 20 A 10 kA \geq 25 A	
Ultimate breaking capacity I_{cu} at 254/440 V~		15 kA $<$ 2 A 10 kA $>$ 2 A... $<$ 10 A 6 kA $>$ 10 A	
Service breaking capacity I_{cs} at 230/400 V~		50 kA \leq 2 A 15 kA $>$ 2 A... \leq 20 A 7.5 kA \geq 25 A	AC und DC 75% von I_{cu}
Service breaking capacity I_{cs} at 254/440 V~		15 kA \leq 2 A 6 kA $>$ 2 A... \leq 10 A 3 kA $>$ 10 A	
Energy limiting class:	3 (B, C up to and including 40 A)		
Terminal at load side S400:	Opposing action stroke clamp on cylinder finger-proof suitable to clamp single-, multi- and fine-wired conductors of up to 25 mm ²	Opposing action stroke clamp on cylinder finger-proof suitable to clamp single-, multi- and fine-wired conductors of up to 25 mm ²	Opposing action stroke clamp on cylinder finger-proof suitable to clamp single-, multi- and fine-wired conductors of up to 25 mm ²
Tightening torque:	2.8 Nm	2.8 Nm	2.8 Nm
Degree of protection:	IP20	IP20	
Endurance:	$I_n < 32$ A: 20 000 operating cycles $I_n \geq 32$ A: 10 000 operating cycles	$I_n < 32$ A: 20 000 operating cycles $I_n \geq 32$ A: 10 000 operating cycles	
Climatic resistance:	Constant climate 23/83, 40/93 55/20 [°C/RF] Alternating climate 25/95 – 40/93 [°C/RF]	Constant climate 23/83, 40/93 55/20 [°C/RF] Alternating climate 25/95 – 40/93 [°C/RF]	
Mounting position:	any	any	
Storage temperature:	$T_{max} +70$ °C, $T_{min} -40$ °C	$T_{max} +70$ °C, $T_{min} -40$ °C	$T_{max} +70$ °C, $T_{min} -40$ °C
Ambient temperature:	$T_{max} +55$ °C, $T_{min} -25$ °C	$T_{max} +55$ °C, $T_{min} -25$ °C	$T_{max} +55$ °C, $T_{min} -25$ °C
from Shock protection:	30 g, at least 2 impacts, shock lasting 13 ms	30 g, at least 2 impacts, shock lasting 13 ms	30 g, at least 2 impacts, shock lasting 13 ms
Vibration resistance acc. to DIN EN 60 068-2-6:	5 g, 20 frequency cycles 5...150...5 Hz at 0.8 I_n	5 g, 20 frequency cycles 5...150...5 Hz at 0.8 I_n	DC 8500 mechanical 1500 electric $\tau = 2$ ms
Plastic:	halogen-free	halogen-free	halogen-free
Contacts:	cadmium-free	cadmium-free	cadmium-free

Miniature circuit breaker

Trip characteristics

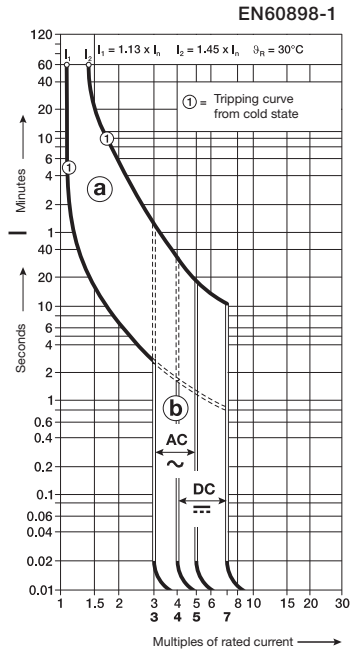

Trip characteristics: B

Thermal trip
 $1.13 \dots 1.45 \times I_n$
 Electromagnetic trip
 $3 \dots 5 \times I_n$ AC
 $4 \dots 7 \times I_n$ DC
 Calibration temperature 30°C

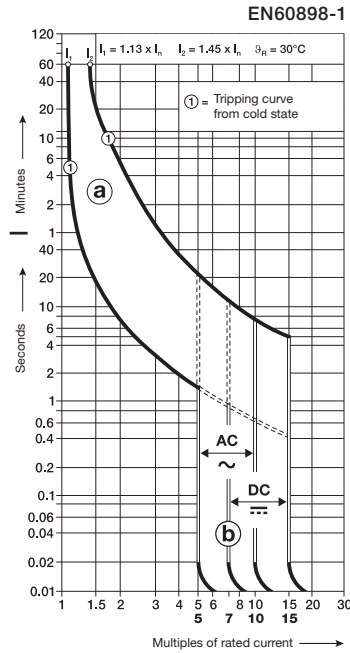

Trip characteristics: C

Thermal trip
 $1.13 \dots 1.45 \times I_n$ acc. to EN60898-1
 Thermal trip
 $1.05 \dots 1.3 \times I_n$ acc. to EN60947-2
 Electromagnetic trip
 $5 \dots 10 \times I_n$ AC
 $7 \dots 14 \times I_n$ DC
 Calibration temperature 30°C

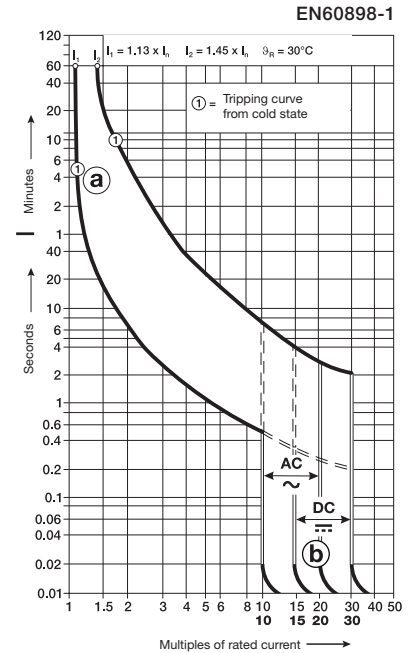

Trip characteristics: D

Thermal trip
 $1.13 \dots 1.45 \times I_n$
 Electromagnetic trip
 $10 \dots 20 \times I_n$ AC
 $10 \dots 21 \times I_n$ DC
 Calibration temperature 30°C

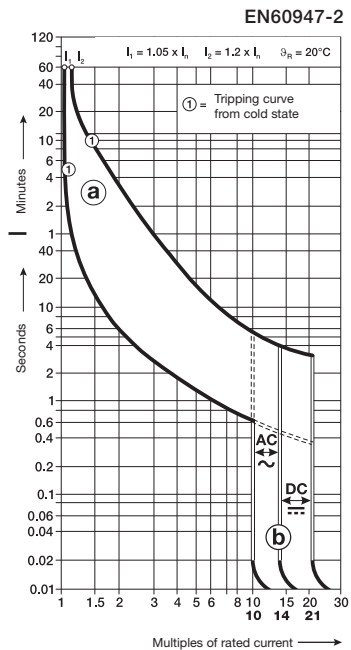

Trip characteristics: K

Thermal trip
 $1.05 \dots 1.2 \times I_n$
 Electromagnetic trip
 $8 \dots 12 \times I_n$ AC
 $8 \dots 18 \times I_n$ DC
 Calibration temperature 40°C

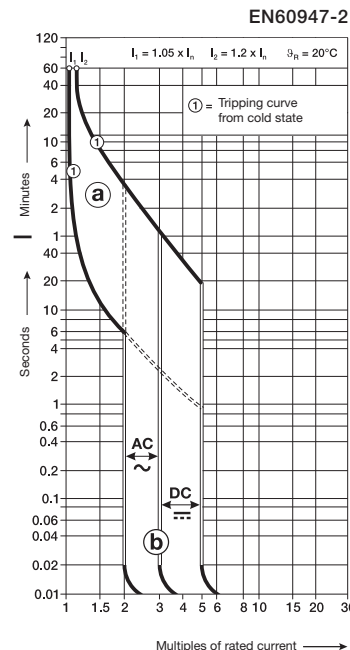

Trip characteristics: UC

Z	C
$1.05 \dots 1.35 \times I_n$	$1.13 \dots 1.45 \times I_n$
$3 \dots 5 \times I_n$ DC	$7 \dots 14 \times I_n$ DC
$2 \dots 3 \times I_n$ AC	$5 \dots 10 \times I_n$ AC
Calibration temperature 30°C		

Miniature circuit breaker

Trip characteristics

Trip characteristics example of trip curve interpretation of B-characteristics

a Thermal trip characteristics:

Lower test current I_1 = defined as non-tripping current.
 The circuit breaker withstands 1.13 times the rated current for at least 60 minutes.
 Upper test current I_2 = defined as trip current.
 The circuit breaker trips at 1.45 times the rated current within 60 minutes.

b Electro-magnetic trip characteristics AC:

The circuit breaker withstands 3 times the rated current for more than 0.1 sec. (in this example, up to around 2 sec.).
 The circuit breaker trips in less than 0.1 sec. at 5 times the rated current.

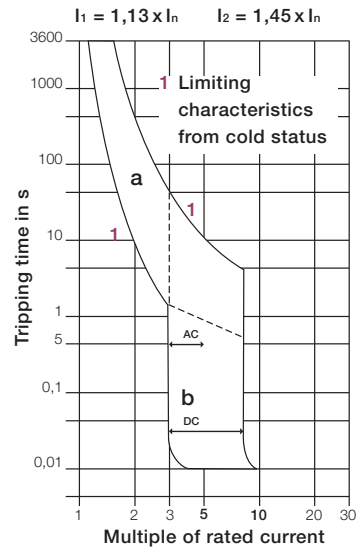

2CCC451013Z0001

Trip behaviour of different trip characteristics

Trip characteristics and current ratings	Thermal release		Trip time	Electromagnetic release		Trip time
	Test currents: lower test current I_1	upper test current I_2		Test currents: lower test current	upper test current	
B 4 to 63 A	$1.13 \times I_n$	$1.45 \times I_n$	> 1 h < 1 h	$3 \times I_n$	$5 \times I_n$	> 0.1 s < 0.1 s
C 0.5 to 63 A	$1.13 \times I_n$	$1.45 \times I_n$	> 1 h < 1 h	$5 \times I_n$	$10 \times I_n$	> 0.1 s < 0.1 s
D 6 to 63 A	$1.13 \times I_n$	$1.4 \times I_n$	> 1 h < 1 h	$10 \times I_n$	$20 \times I_n$	> 0.1 s < 0.1 s
K 0.5 to 63 A	$1.05 \times I_n$	$1.2 \times I_n$ $1.5 \times I_n$ $6.0 \times I_n$	> 2 h < 2 h < 2 min > 2 s	$8 \times I_n$	$12 \times I_n$	> 0.2 s < 0.2 s

Application characteristics: B

Miniature circuit breaker for circuits supplying loads generating no or only minor inrush currents (boilers, electric heaters, cookers).

Application characteristics: C

The 'standard' miniature circuit breaker for circuits supplying loads producing inrush currents particular to inductive loads (TV sets, fluorescent and discharge lamps) and for socket outlets.

Application characteristics: D

Miniature circuit breaker for circuits supplying loads producing very high inrush currents (transformers, capacitor banks).

Main circuit breaker for the back-up protection of downstream connected circuit breakers.

Application characteristics: K

Circuit breaker for equipment: The characteristics of these types enable the close protection requirements for equipment to be met.

Application characteristics: UC

Device protection in DC systems of up to 250 V = with a time constant of ≤ 15 ms (emergency networks, electroplating, etc.) dependent on polarity.

Miniature circuit breaker

Internal resistances at rated voltage and power losses

Internal resistances and power loss per pole (cold resistance at room temperature)

Rated current I_n A	S400 M B, C, D ¹		K		S400 M-UCC		S400 M-UCZ	
	R_i	P_v	R_i	P_v	R_i	P_v	R_i	P_v
	Ω	W	Ω	W	Ω	W	Ω	W
0.5	5.5	1.4	4.906	1.2	6.34	1.59	6.34	2.61
1	1.44	1.5	1.505	1.5	1.55	1.55	1.55	3.50
1.6	0.63	1.6	0.594	1.5	0.695	1.78	0.695	2.94
2	0.460	1.8	0.415	1.7	0.46	1.84	0.46	3.92
3	0.150	1.4	0.181	1.6	0.165	1.49	0.165	4.46
4	0.123	1.9	0.150	2.4	0.12	1.92	0.12	2.38
6	0.051	1.8	0.080	2.9	0.052	1.87	0.052	3.49
8	0.029	1.9	0.043	2.7	0.038	2.43	0.038	3.46
10	0.012	1.2	0.0165	1.7	0.0126	1.26	0.013	1.30
13	0.0112	1.9	0.0153	2.6	0.0101	1.71	0.010	2.20
16	0.0074	1.9	0.0095	2.4	0.0077	1.79	0.007	1.75
20	0.004	1.6	0.0073	2.9	0.0067	2.68	0.0067	2.52
25	0.0032	2	0.0053	3.3	0.0046	2.88	0.005	3.13
32	0.0026	2.7	0.0034	3.4	0.0025	3.58	0.0025	3.69
40	0.0026	4.2	0.0028	4.5	0.0028	4.48	0.003	4.80
50	0.0017	4.3	0.0021	5.3	0.0012	3.00	0.0012	3.00
63	0.0014	5.6	0.0015	5.9	0.0007	2.78	0.0007	3.57

¹ Currents 0.5–4 A only apply to C and K characteristics.

Miniature circuit breaker

Let through energies I^2t at 230/400 VAC

Miniature circuit breaker S400 B and D characteristics

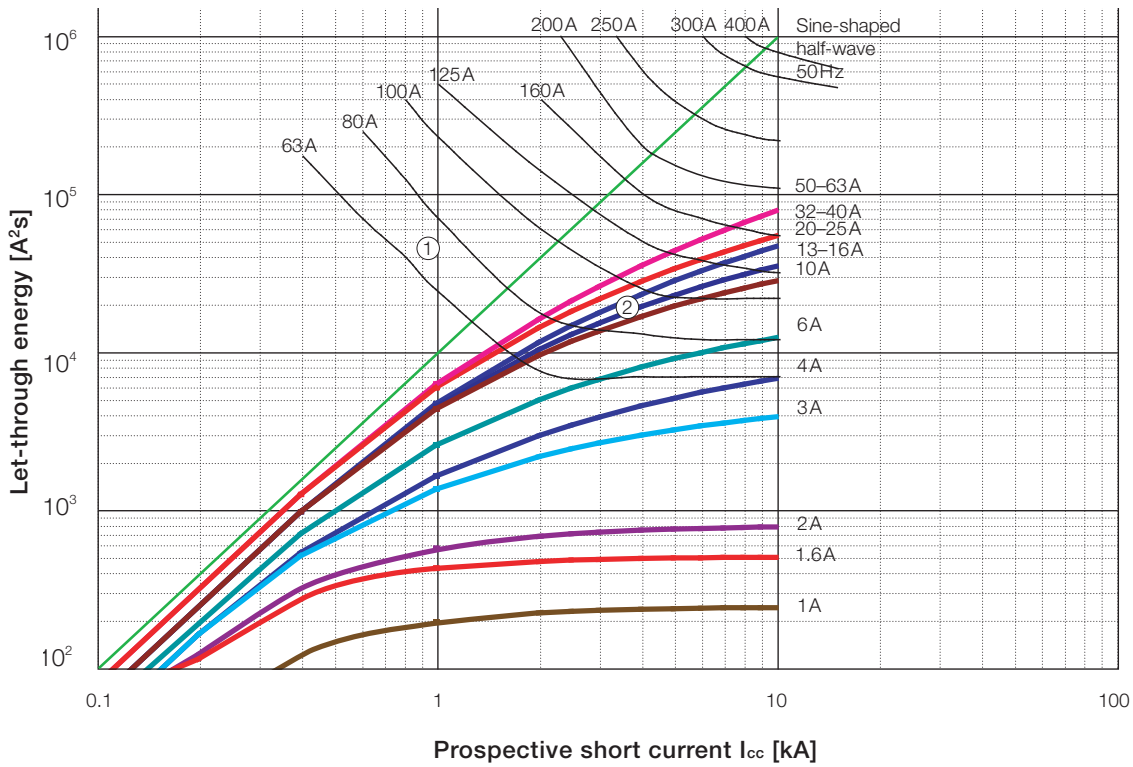

2CCC451021Z0001

Miniature circuit breaker S400 C and K characteristics

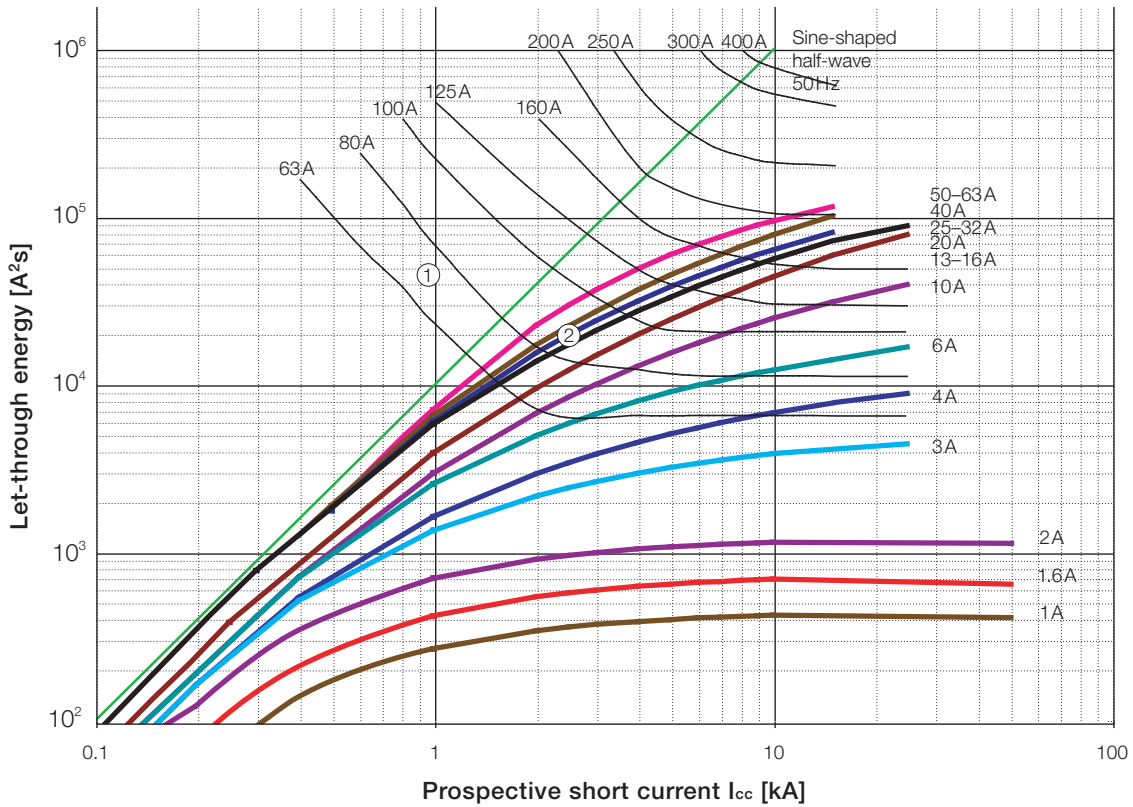

2CCC451022Z0001

① min melting I^2t , e.g. $I_n = 80A$ gL

② max. I^2t let through energy of miniature circuit breaker, e.g. B20A

Example:

- SMCB, selectivity to the upstream fuse up to the point of intersection curve ① and ②, e.g. S400 C20 to fuse 80A:
- Selectivity up to at least 2.2kA

- Let through energy values I^2t can be reduced for:
 127V ~ by a factor of 2.5
 110V ~ by a factor of 3

Power supply: overload and short-circuit protection

Overload and short-circuit protection of the plug-in socket system

Protection of the busbar system without upstream overcurrent protection

An important factor for the protection of the busbar system (sockets, incoming terminal block, incoming terminal component, adapter, combi module or terminals) is the characteristic of the rated peak withstand current I_{pk} . The rated peak withstand current I_{pk} of the SMISLINE busbar system is 17 kA.

Protection of the busbar system with upstream overcurrent protection

The rated short-circuit current I_{cf} of the SMISLINE busbar system is 50 kA.

If, on the power supply side, a circuit breaker of the type Sace Tmax 200 A, a high performance circuit breaker S800 or a NH fuse is positioned upstream of the busbar system, then due to the short-circuit current limiting effect of this protection device, a larger prospective short-circuit current of up to 50 kA for the plug-in socket system is permissible.

Overload and short-circuit protection of devices on the busbar system

The rated short-circuit breaking capacity (or rated breaking capacity) of the protective devices, together with the maximum short-circuit current at the installation location of the devices on the busbar system, must be taken into consideration.

This is not only relevant for the SMISLINE busbar system, but is also applicable to the distribution construction.

Miniature circuit breaker

If the prospective short-circuit current at the installation location of a miniature circuit breaker is not greater than its rated breaking capacity, no back-up protection via an upstream overcurrent protection device is necessary.

If the prospective short-circuit current at the installation location of a miniature circuit breaker is greater than its rated short-circuit breaking capacity, the current ratings of the upstream overcurrent protection device must not exceed the table values in the back-up tables (catalogue, page 2/20 onwards).

Residual-current circuit breaker

A back-up fuse with max. 100 A gL/gG or a high performance circuit breaker S800 100 A is required for short-circuit protection upstream or downstream (see Coordination table, page 2/42). A back-up fuse is not required up to the level of the internal short-circuit withstand rating. Thermal protection can be ensured by means of downstream miniature circuit breakers, but only if the rated currents do not exceed the value of the current rating of the residual-current circuit breaker in consideration of a utilisation factor.

Surge arrester OVR

An upstream overcurrent protection device with max. 160 A gL/gG is necessary for short-circuit protection (in the case of non-independent interruptions of the secondary current).

Back-up fuses for devices with a universal adapter

In principle, the same requirements apply as for directly plugged-in devices.

Miniature circuit breaker

Back-up and selectivity dates

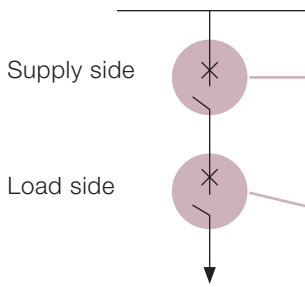

S800N - S400E @ 230/400V												
L.	Char.	I _{cu} [kA]	I _n [A]	E.								
				S800N								
				B, C, D								
S400E	B	6	6	25	32	40	50	63	80	100	125	
			10	36	36	36	36	36	36	36	36	36
			13	36	36	36	36	36	36	36	36	36
			16	36	36	36	36	36	36	36	36	36
			20	36	36	36	36	36	36	36	36	36
			25	36	36	36	36	36	36	36	36	36
			32	36	36	36	36	36	36	36	36	36
			40	36	36	36	36	36	36	36	36	36
			50	36	36	36	36	36	36	36	36	36
			63	36	36	36	36	36	36	36	36	36

Example 1: With a S800 nominal current 50A is a Back-up protection till a nominal current of 25A to a S400 given. The Back-up protection ist till 36kA.

Example 2: There is no Back-up protection between supply side and the load side given.

Back-up protection

The tables given provide the value (in kA, referring to the breaking capacity) for which the back-up protection among the combination of selected circuit breakers is verified. The tables cover the possible combinations between S800 and those between the above mentioned circuit breakers and the ABB series of modular circuit breakers S400.

The values indicated in the tables refer to the voltage:

- V_n of 230/400VAC

L.	Char.	I _{cu} [kA]	I _n [A]	E.								
				S800S								
				D								
S400M S450M	C	50	0.5	25	32	40	50	63	80	100	125	
			1	T	T	T	T	T	T	T	T	T
			1.6	T	T	T	T	T	T	T	T	T
			2	T	T	T	T	T	T	T	T	T
			3	0.7	2	4	T	T	T	T	T	T
			4	0.6	1.2	2	4	7	T	T	T	T
		25	6	0.5	0.9	1.1	1.8	2.5	9	T	T	T
			8	0.4	0.5	0.8	1	1.3	2.5	3.5	6.7	6.7
			10	0.4	0.5	0.8	1	1.3	2.5	3.5	6.7	6.7
			13	0.4	0.5	0.8	1	1.3	2.5	3	5.1	5.1
			16	0.5	0.8	1	1.3	2.3	3	5.1	5.1	5.1
15	20	0.7	1	1.2	2.1	2.7	4.3	4.3	4.3	4.3		
	25	0.7	1	1.2	2.1	2.7	4.3	4.3	4.3	4.3		
	32	0.9	1	1.7	2.2	3.4	3.4	3.4	3.4	3.4		
	40	1	1.7	2.2	3.4	3.4	3.4	3.4	3.4	3.4		
	50	1.4	1.7	2.1	2.1	2.1	2.1	2.1	2.1	2.1		

Example 1: In this combination is a selectivity switch off till 5.1 kA given.

Example 2: There is no selectivity.

Selective protection

The tables given provide the value (in kA, referring to the breaking capacity) for which the selective protection is verified among the combination of selected circuit breakers. The tables cover the possible combinations between S800 and the ABB series of modular circuit breakers.

The values in the table represent the maximum value obtainable of discrimination between supply side circuit breaker and load side circuit breaker referring to the voltage:

- V_n of 230/400VAC

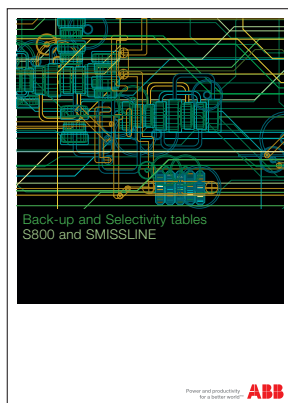

More Back-up- and Selektivty tables:
see www.abb.ch

- Catalogue 2CCC451039L0203

Miniature circuit breaker

Back-up protection with fuses, S800 and Tmax

a) If the short-circuit current at the point of installation of the circuit breaker is not greater than the nominal breaking capacity of the MCB, an upstream fuse is not needed. If a fuse is fitted upstream for installation reasons, any nominal current may be selected for the fuse.

b) If the short-circuit current at the point of installation of the circuit breaker is greater than its nominal breaking capacity, the nominal currents of the upstream fuses must not exceed the values specified in the table (back-up protection of the circuit breaker).

Upstream: Fuse NH..gL/gG

L.	I _{cu} [kA]	I _{cn} [kA]	I _n [A] all types	NH gL/gG													
				125	160												
S400M FS401M FS403M	10	10		50	35												

S800S – S400M (SMISSLINE) @ 230/400 V

L.	Char.	I _{cu} [kA]	I _{cn} [kA]	I _n [A]	S800S														
					B, C, D, K														
					50														
S400M FS401M FS403M	B, D	10	4*...16	25	32	40	50	63	80	100	125								
			20		50	50	50	50	50	50	50	50	50						
			25			50	50	50	50	50	50	50	50						
			32				50	50	50	50	50	50	50						
			40						50	50	50	50	50						
			50								50	50	50						
			63														50	50	

L.	Char.	I _{cu} [kA]	I _{cn} [kA]	I _n [A]	S800S														
					B, C, D, K														
					50														
S400M	C, K	15	50	0.5...2	25	32	40	50	63	80	100	125							
			25	3...20	50	50	50	50	50	50	50	50	50						
				25			50	50	50	50	50	50	50						
				32				50	50	50	50	50	50						
				40						50	50	50	50						
				50								50	50	50					
			63														50	50	

S800N – S400M (SMISSLINE) @ 230/400 V

L.	Char.	I _{cu} [kA]	I _{cn} [kA]	I _n [A]	S800N													
					B, C, D													
					36													
S400M FS401M FS403M	B, D	10	4*...16	25	32	40	50	63	80	100	125							
			20		36	36	36	36	36	36	36	36						
			25			36	36	36	36	36	36	36						
			32				36	36	36	36	36	36						
			40						36	36	36	36						
			50									36	36					
			63														36	36

L.	Char.	I _{cu} [kA]	I _{cn} [kA]	I _n [A]	S800 N														
					B, C, D														
					36														
S400M	C, K	15	50	0.5...2	25	32	40	50	63	80	100	125							
			25	3...20	36	36	36	36	36	36	36	36							
				25			36	36	36	36	36	36	36						
				32				36	36	36	36	36	36						
				40						36	36	36	36						
				50								36	36						
			63														36	36	

E. = Upstream
L. = Downstream
Selectivity limits are specified in kA

Sace Tmax – S400 @ 230/400 V

Downstream	Version	I _n [A]	Up-Stream I _{cu} [kA]	T1	T1	T1	T2	T3	T4	T2	T3	T4	T2	T4	T2	T4	T4
				B	C	N	N	N	N	S	S	S	H	H	L		V
S400E FS401E/403E	B, C	6...10	6	16	25	36	36	36	36	50	50	50	70	70	85	120	200
		13...63		16	25	30	36		36	40	40	40	30	40	40	40	
S400M FS401M/403M	C, K	0.5...10	10	16	25	30	36	36	36	40	40	40	50	40	50	40	40
		13...63		16	25	30	36	25	36	40	25	40	50	40	50	40	40
S400M FS401M/403M	B, D	6...10	10	16	25	30	36	36	36	40	40	40	50	40	50	40	40
		13...63		16	25	30	36	25	36	40	25	40	50	40	50	40	40

Consulting the back-up table

This table provides the value (in kA) for which the back-up protection is ensured between a given combination of circuit breakers. The table covers possible combinations between the S800 or SACE series Tmax and between SMISSLINE miniature circuit breakers 400 M.

Miniature circuit breaker

Selectivity to fuses gL/gG

In a low voltage distribution system service continuity is much desired. This means, that two or more in series connected over-current protection devices should operate selective in case of an overload or a short circuit. Selectivity is achieved, if only the protective device closest to the fault location operates. Selectivity between fuse and circuit breaker is assured, if the let through energy of the downstream installed circuit breaker does not reach the value of the melting energy of the upstream connected fuse. In case of a short circuit a selective interruption of the fault current by the SMISSLINE miniature circuit breaker is assured up to the values indicated in the tables. The information is based on the average operating curves of the upstream connected fuses.

Fuse gL/gG – S400M @ 230/400 V												
		Upstream	Fuse gL/gG									
Downstream	Char.	In [A]	16	20	25	35	50	63	80	100	125	160
S400M FS401M FS403M	B, C	≤ 2	1	1.2	4	>15 *	>15 *	>15 *	>15 *	>15 *	>15 *	>15 *
		3	0.3	0.7	1.2	4.6	6	6	6	6	6	6
		4	0.3	0.6	0.9	2.8	6	6	6	6	6	6
		6	0.2	0.5	0.8	2	3.3	5.5	6	6	6	6
		8	0.2	0.4	0.7	1.7	2.8	4.5	6	6	6	6
		10	0.2	0.4	0.7	1.5	2.5	3.5	5	6	6	6
		13			0.7	1.5	2.5	3.5	5	6	6	6
		16				1.3	2	2.9	4.1	6	6	6
		20					1.8	2.6	3.5	5	6	6
		25					1.8	2.6	3.5	5	6	6
		32						2.2	3	4	6	6
		40							2.5	4	6	6
50/63								3.5	5	6		

Fuse gL/gG – S400M @ 230/400 V												
		Upstream	Fuse gL/gG									
Downstream	Char.	In [A]	16	20	25	35	50	63	80	100	125	160
S400M	D, K	≤ 2	0.3	1.2	4	>15 *	>15 *	>15 *	>15 *	>15 *	>15 *	>15 *
		3	0.3	0.7	1.2	4.6	6	6	6	6	6	6
		4	0.3	0.6	0.9	2.8	6	6	6	6	6	6
		6			0.7	1.7	3	5.9	6	6	6	6
		8				1.3	2.2	3.6	6	6	6	6
		10					1.7	2.5	4	6	6	6
		13						2.2	3.1	4.6	6	6
		16							3.1	4.6	6	6
		20							2.6	3.5	6	6
		25								3.5	6	6
		32									5.5	6
		40										6
50/63												

E. = Upstream L. = Downstream
 T = total selectivity up to breaking capacity of downstream miniature circuit breaker
 Selectivity limits are specified in kA

* only applies to IEC/EN 60947-2 characteristics C and K

Miniature circuit breaker S400M

Selectivity to S800S

S800S – S400M (SMISSLINE) @ 230/400V

L.	Char.	S.	S800S											
			I _{cu} [kA]	B										
				50										
		I _n [A]	25	32	40	50	63	80	100	125				
S400M FS401M FS403M	B	10	I _{cn} [kA]	6			0.4	0.5	0.6	0.9	1.4	2.4		
				10				0.4	0.5	0.7	0.9	1.3		
				13					0.5	0.7	0.9	1.2		
				16						0.7	0.9	1.2		
				20							0.9	1.2		
				25							0.9	1.2		
				32							0.7	1		
				40							0.7	1		
				50								0.9		
				63								0.9		

S800S – S400M (SMISSLINE) @ 230/400V

L.	Char.	S.	S800S												
			I _{cu} [kA]	C											
				50											
		I _n [A]	25	32	40	50	63	80	100	125					
S400M FS401M FS403M	B	10	I _{cn} [kA]	6		0.4	0.5	0.6	0.9	1.3	2.2	4.4			
				10		0.3	0.4	0.5	0.6	0.8	1.2	1.8			
				13			0.3	0.4	0.5	0.6	0.8	1.2	1.7		
				16			0.3	0.4	0.5	0.6	0.8	1.2	1.7		
				20				0.4	0.5	0.6	0.8	1.1	1.6		
				25				0.4	0.5	0.6	0.8	1.1	1.6		
				32					0.4	0.5	0.7	0.9	1.3		
				40						0.5	0.7	0.9	1.3		
				50							0.7	0.9	1.2		
				63								0.8	1.1		

L.	Char.	S.	S800S										
			I _{cu} [kA]	B									
				50									
		I _n [A]	25	32	40	50	63	80	100	125			
S400M FS401M FS403M	C	50	0.5	T	T	T	T	T	T	T	T	T	
			1	3	T	T	T	T	T	T	T	T	
			1.6	1	1	T	T	T	T	T	T	T	
			2	0	1	1.2	T	T	T	T	T	T	
			3	0	0.6	0.7	1	2.4	T	T	T	T	
			4	0	0.5	0.6	0.9	1.5	2.8	T	T	T	
		25	6			0.4	0.5	0.6	0.9	1.4	2.4		
			8				0.4	0.5	0.7	0.9	1.3		
			10				0.4	0.5	0.7	0.9	1.3		
			13					0.5	0.7	0.9	1.2		
			16						0.7	0.9	1.2		
			20							0.9	1.2		
	15	25							0.9	1.2			
		32							0.7	1			
		40							0.7	1			
		50								0.9			
		63								0.9			

L.	Char.	S.	S800S										
			I _{cu} [kA]	C									
				50									
		I _n [A]	25	32	40	50	63	80	100	125			
S400M FS401M FS403M	C	50	0.5	T	T	T	T	T	T	T	T	T	
			1	T	T	T	T	T	T	T	T	T	
			1.6	1	T	T	T	T	T	T	T	T	
			2	0	0.9	T	T	T	T	T	T	T	
			3	0	0.4	0.7	1.1	1.9	5.8	T	T	T	
			4	0	0.4	0.6	0.9	1.3	2.4	5.5	T	T	
		25	6			0.4	0.5	0.6	0.9	1.3	2.2	4.4	
			8				0.3	0.4	0.5	0.6	0.8	1.2	1.8
			10				0.3	0.4	0.5	0.6	0.8	1.2	1.8
			13				0.3	0.4	0.5	0.6	0.8	1.2	1.7
			16				0.3	0.4	0.5	0.6	0.8	1.2	1.7
			20					0.4	0.5	0.6	0.8	1.1	1.6
	15	25					0.4	0.5	0.6	0.8	1.1	1.6	
		32						0.4	0.5	0.7	0.9	1.3	
		40							0.5	0.7	0.9	1.3	
		50								0.7	0.9	1.2	
		63									0.8	1.1	

L.	Char.	S.	S800S											
			I _{cu} [kA]	B										
				50										
		I _n [A]	25	32	40	50	63	80	100	125				
S400M	D	10	I _{cn} [kA]	6			0.5	0.7	1.1	1.8	3.3			
				8				0.6	0.9	1.2	1.8			
				10						0.9	1.2	1.8		
				13							1	1.4		
				16								1.4		
				20										
				25										
				32										
				40										
				50										
				63										

L.	Char.	S.	S800S										
			I _{cu} [kA]	C									
				50									
		I _n [A]	25	32	40	50	63	80	100	125			
S400M	D	10	I _{cn} [kA]	6		0.4	0.5	0.7	1	1.6	2.9	5.8	
				8			0.5	0.6	0.8	1.1	1.6	2.5	
				10				0.6	0.8	1.1	1.6	2.5	
				13					0.7	0.9	1.3	1.8	
				16						0.9	1.3	1.8	
				20							0.9	1.3	
				25								1.3	
				32									
				40									
				50									
				63									

L.	Char.	S.	S800S										
			I _{cu} [kA]	B									
				50									
		I _n [A]	25	32	40	50	63	80	100	125			
S400M	K	50	0.5	T	T	T	T	T	T	T	T	T	
			1	1	5	T	T	T	T	T	T	T	
			1.6	0	1	2.1	T	T	T	T	T	T	
			2	0	1	0.7	2.1	T	T	T	T	T	
			3	0	0.4	0.7	1.1	2.3	7.8	T	T	T	
			4	0	0.4	0.6	0.9	1.5	2.8	7	T	T	
		25	6				0.5	0.7	1.1	1.8	3.3		
			8					0.6	0.9	1.2	1.8		
			10						0.9	1.2	1.8		
			13							1	1.4		
			16								1.4		
			20										
	10	25											
		32											
		40											
		50											
		63											

L.	Char.	S.	S800S										
			I _{cu} [kA]	C									
				50									
		I _n [A]	25	32	40	50	63	80	100	125			
S400M	K	50	0.5	T	T	T	T	T	T	T	T	T	
			1	2	T	T	T	T	T	T	T	T	
			1.6	1	2.1	T	T	T	T	T	T	T	
			2	0	0.7	2.1	T	T	T	T	T	T	
			3	0	0.4	0.7	1.1	2	5.8	T	T	T	
			4	0	0.4	0.6	0.9	1.3	2.4	5.6	T	T	
		25	6			0.4	0.5	0.7	1	1.6	2.9	5.8	
			8				0.5	0.6	0.8	1.1	1.6	2.5	
			10					0.6	0.8	1.1	1.6	2.5	
			13						0.7	0.9	1.3	1.8	
			16							0.9	1.3	1.8	
			20								0.9	1.3	
	10	25									1.3		
		32											
		40											
		50											
		63											

S. = Upstream L. = Downstream
 T = total selectivity up to breaking capacity of downstream miniature circuit breaker
 Selectivity limits are specified in kA

Miniature circuit breaker S400M

Selectivity to S800S and S800N

S800S – S400M (SMISSLINE) @ 230/400V

L.	Char.	S.		S800S							
		I _{cu} [kA]	I _n [A]	D							
				50							
S400M FS401M FS403M	B	10	6	0.5	0.9	1.1	1.8	2.5	9	T	T
			10	0.4	0.5	0.8	1	1.3	2.5	3.5	6.7
			13	0.4	0.5	0.8	1	1.3	2.3	3	5.1
			16		0.5	0.8	1	1.3	2.3	3	5.1
			20			0.7	1	1.2	2.1	2.7	4.3
			25			0.7	1	1.2	2.1	2.7	4.3
			32				0.9	1	1.7	2.2	3.4
			40					1	1.7	2.2	3.4
			50						1.4	1.7	2.1
			63							1.6	2.1

L.	Char.	S.		S800S							
		I _{cu} [kA]	I _n [A]	D							
				50							
S400M FS401M FS403M	C	50	0.5	T	T	T	T	T	T	T	T
			1	T	T	T	T	T	T	T	T
			1.6	T	T	T	T	T	T	T	T
			2	T	T	T	T	T	T	T	T
			3	0.7	2	4	T	T	T	T	T
			4	0.6	1.2	2	4	7	T	T	T
		25	6	0.5	0.9	1.1	1.8	2.5	9	T	T
			8	0.4	0.5	0.8	1	1.3	2.5	3.5	6.7
			10	0.4	0.5	0.8	1	1.3	2.5	3.5	6.7
			13	0.4	0.5	0.8	1	1.3	2.3	3	5.1
			16		0.5	0.8	1	1.3	2.3	3	5.1
			20			0.7	1	1.2	2.1	2.7	4.3
		15	25			0.7	1	1.2	2.1	2.7	4.3
			32				0.9	1	1.7	2.2	3.4
			40					1	1.7	2.2	3.4
			50						1.4	1.7	2.1
			63							1.6	2.1

L.	Char.	S.		S800S							
		I _{cu} [kA]	I _n [A]	D							
				50							
S400M	D	10	6	0.5	0.8	1.4	2.3	3.3	T	T	T
			8	0.5	0.6	1	1.4	1.8	3.6	5	9
			10	0.5	0.6	1	1.4	1.8	3.6	5	9
			13		0.5	0.8	1.1	1.4	2.4	3.1	4.7
			16			0.8	1.1	1.4	2.4	3.1	4.7
			20				0.8	1	1.6	2	2.9
			25					1	1.6	2	2.9
			32						1.5	1.8	2.6
			40							1.7	2.4
			63								2

L.	Char.	S.		S800S							
		I _{cu} [kA]	I _n [A]	D							
				50							
S400M	K	50	0.5	T	T	T	T	T	T	T	T
			1	T	T	T	T	T	T	T	T
			1.6	T	T	T	T	T	T	T	T
			2	2.1	T	T	T	T	T	T	T
			3	0.7	1.2	4	T	T	T	T	T
			4	0.6	0.9	2	4	7	T	T	T
		25	6	0.5	0.8	1.4	2.3	3.3	T	T	T
			8	0.5	0.6	1	1.4	1.8	3.6	5	T
			10	0.5	0.6	1	1.4	1.8	3.6	5	T
			13		0.5	0.8	1.1	1.4	2.4	3.1	4.7
			16			0.8	1.1	1.4	2.4	3.1	4.7
			20				0.8	1	1.6	2	2.9
		10	25					1	1.6	2	2.9
			32						1.5	1.8	2.6
			40							1.7	2.4
			50								2
			63								

E. = Upstream L. = Downstream
T = total selectivity up to breaking capacity of downstream miniature circuit breaker
Selectivity limits are specified in kA

Miniature circuit breaker S400M

Selectivity to S800N

S800N – S400M (SMISSLINE) @ 230/400V

L.	Char.	S.	S800 N								
			I _{cu} [kA]	B							
				I _n [A]	25	32	40	50	63	80	100
S400M FS401M FS403M	B	10	6			0.4	0.5	0.6	0.9	1.4	2.4
			10				0.4	0.5	0.7	0.9	1.3
			13					0.5	0.7	0.9	1.2
			16						0.7	0.9	1.2
			20							0.9	1.2
			25							0.9	1.2
			32							0.7	1
			40							0.7	1
			50								0.9
			63								0.9

S800N – S400M (SMISSLINE) @ 230/400V

L.	Char.	S.	S800N								
			I _{cu} [kA]	C							
				I _n [A]	25	32	40	50	63	80	100
S400M FS401M FS403M	B	10	6		0.4	0.5	0.6	0.9	1.3	2.2	4.4
			10		0.3	0.4	0.5	0.6	0.8	1.2	1.8
			13		0.3	0.4	0.5	0.6	0.8	1.2	1.7
			16		0.3	0.4	0.5	0.6	0.8	1.2	1.7
			20			0.4	0.5	0.6	0.8	1.1	1.6
			25			0.4	0.5	0.6	0.8	1.1	1.6
			32				0.4	0.5	0.7	0.9	1.3
			40					0.5	0.7	0.9	1.3
			50						0.7	0.9	1.2
			63							0.8	1.1

L.	Char.	S.	S800 N								
			I _{cu} [kA]	B							
				I _n [A]	25	32	40	50	63	80	100
S400M FS401M FS403M	C	50	0.5	T	T	T	T	T	T	T	T
			1	3	T	T	T	T	T	T	T
			1.6	1	1	T	T	T	T	T	T
			2	0	1	1.2	T	T	T	T	T
			3		0	0.6	0.7	1	2.4	T	T
			4		0	0.5	0.6	0.9	1.5	2.8	T
		25	6			0.4	0.5	0.6	0.9	1.4	2.4
			8				0.4	0.5	0.7	0.9	1.3
			10				0.4	0.5	0.7	0.9	1.3
			13					0.5	0.7	0.9	1.2
			16						0.7	0.9	1.2
			20							0.9	1.2
	15	25							0.9	1.2	
		32							0.7	1	
		40							0.7	1	
		50								0.9	
		63								0.9	

L.	Char.	S.	S800N								
			I _{cu} [kA]	C							
				I _n [A]	25	32	40	50	63	80	100
S400M FS401M FS403M	C	50	0.5	T	T	T	T	T	T	T	T
			1	T	T	T	T	T	T	T	T
			1.6	1	T	T	T	T	T	T	T
			2	0	0.9	T	T	T	T	T	T
			3	0	0.4	0.7	1.1	1.9	5.8	T	T
			4	0	0.4	0.6	0.9	1.3	2.4	5.5	T
		25	6		0.4	0.5	0.6	0.9	1.3	2.2	4.4
			8		0.3	0.4	0.5	0.6	0.8	1.2	1.8
			10		0.3	0.4	0.5	0.6	0.8	1.2	1.8
			13		0.3	0.4	0.5	0.6	0.8	1.2	1.7
			16		0.3	0.4	0.5	0.6	0.8	1.2	1.7
			20			0.4	0.5	0.6	0.8	1.1	1.6
	15	25			0.4	0.5	0.6	0.8	1.1	1.6	
		32				0.4	0.5	0.7	0.9	1.3	
		40					0.5	0.7	0.9	1.3	
		50						0.7	0.9	1.2	
		63							0.8	1.1	

L.	Char.	S.	S800N								
			I _{cu} [kA]	B							
				I _n [A]	25	32	40	50	63	80	100
S400M	D	10	6				0.5	0.7	1.1	1.8	3.3
			8					0.6	0.9	1.2	1.8
			10						0.9	1.2	1.8
			13							1	1.4
			16								1.4
			20								
			25								
			32								
			40								
			50								
63											

L.	Char.	S.	S800N								
			I _{cu} [kA]	C							
				I _n [A]	25	32	40	50	63	80	100
S400M	D	10	6		0.4	0.5	0.7	1	1.6	2.9	5.8
			8			0.5	0.6	0.8	1.1	1.6	2.5
			10				0.6	0.8	1.1	1.6	2.5
			13					0.7	0.9	1.3	1.8
			16						0.9	1.3	1.8
			20							0.9	1.3
			25								1.3
			32								
			40								
			50								
63											

L.	Char.	S.	S800N								
			I _{cu} [kA]	B							
				I _n [A]	25	32	40	50	63	80	100
S400M	K	50	0.5	T	T	T	T	T	T	T	T
			1	1	5	T	T	T	T	T	T
			1.6	0	1	2.1	T	T	T	T	T
			2	0	1	0.7	2.1	T	T	T	T
			3		0	0.4	0.7	1.1	2.3	7.8	T
			4		0	0.4	0.6	0.9	1.5	2.8	7
		25	6				0.5	0.7	1.1	1.8	3.3
			8					0.6	0.9	1.2	1.8
			10						0.9	1.2	1.8
			13							1	1.4
			16								1.4
			20								
	10	25									
		32									
		40									
		50									
		63									

L.	Char.	S.	S800N								
			I _{cu} [kA]	C							
				I _n [A]	25	32	40	50	63	80	100
S400M	K	50	0.5	T	T	T	T	T	T	T	T
			1	2	T	T	T	T	T	T	T
			1.6	1	2.1	T	T	T	T	T	T
			2	0	0.7	2.1	T	T	T	T	T
			3	0	0.4	0.7	1.1	2	5.8	T	T
			4	0	0.4	0.6	0.9	1.3	2.4	5.6	T
		25	6		0.4	0.5	0.7	1	1.6	2.9	5.8
			8			0.5	0.6	0.8	1.1	1.6	2.5
			10				0.6	0.8	1.1	1.6	2.5
			13					0.7	0.9	1.3	1.8
			16						0.9	1.3	1.8
			20							0.9	1.3
	10	25								1.3	
		32									
		40									
		50									
		63									

E. = Upstream L. = Downstream
 T = total selectivity up to breaking capacity of downstream miniature circuit breaker
 Selectivity limits are specified in kA

Miniature circuit breaker S400M

Selectivity to S800N

S800N – S400M (SMISLINE) @ 230/400V

L.	Char.	S.		S800N							
		I _{cu} [kA]	I _{cn} [kA]	D							
				36							
		I _n [A]	25	32	40	50	63	80	100	125	
S400M FS401M	B	10	6	0.5	0.9	1.1	1.8	2.5	9	T	T
			10	0.4	0.5	0.8	1	1.3	2.5	3.5	6.7
			13	0.4	0.5	0.8	1	1.3	2.3	3	5.1
			16		0.5	0.8	1	1.3	2.3	3	5.1
			20			0.7	1	1.2	2.1	2.7	4.3
			25			0.7	1	1.2	2.1	2.7	4.3
			32				0.9	1	1.7	2.2	3.4
			40					1	1.7	2.2	3.4
			50						1.4	1.7	2.1
			63							1.6	2.1

L.	Char.	S.		S800N							
		I _{cu} [kA]	I _{cn} [kA]	D							
				36							
		I _n [A]	25	32	40	36	63	80	100	125	
S400M FS401M	C	50	0.5	T	T	T	T	T	T	T	T
			1	T	T	T	T	T	T	T	T
			1.6	T	T	T	T	T	T	T	T
			2	T	T	T	T	T	T	T	T
			3	0.7	2	4	T	T	T	T	T
		25	4	0.6	1.2	2	4	7	T	T	T
			6	0.5	0.9	1.1	1.8	2.5	9	T	T
			8	0.4	0.5	0.8	1	1.3	2.5	3.5	6.7
			10	0.4	0.5	0.8	1	1.3	2.5	3.5	6.7
			13	0.4	0.5	0.8	1	1.3	2.3	3	5.1
	15	16		0.5	0.8	1	1.3	2.3	3	5.1	
		20			0.7	1	1.2	2.1	2.7	4.3	
		25			0.7	1	1.2	2.1	2.7	4.3	
		32				0.9	1	1.7	2.2	3.4	
		40					1	1.7	2.2	3.4	
	50						1.4	1.7	2.1		
	63							1.6	2.1		

L.	Char.	S.		S800N							
		I _{cu} [kA]	I _{cn} [kA]	D							
				36							
		I _n [A]	25	32	40	50	63	80	100	125	
S400M	D	10	6	0.5	0.8	1.4	2.3	3.3	T	T	T
			8	0.5	0.6	1	1.4	1.8	3.6	5	9
			10	0.5	0.6	1	1.4	1.8	3.6	5	9
			13		0.5	0.8	1.1	1.4	2.4	3.1	4.7
			16			0.8	1.1	1.4	2.4	3.1	4.7
			20				0.8	1	1.6	2	2.9
			25					1	1.6	2	2.9
			32						1.5	1.8	2.6
			40							1.7	2.4
			50								2
63											

L.	Char.	S.		S800N							
		I _{cu} [kA]	I _{cn} [kA]	D							
				36							
		I _n [A]	25	32	40	50	63	80	100	125	
S400M	K	50	0.5	T	T	T	T	T	T	T	T
			1	T	T	T	T	T	T	T	T
			1.6	T	T	T	T	T	T	T	T
			2	2.1	T	T	T	T	T	T	T
			3	0.7	1.2	4	T	T	T	T	T
		25	4	0.6	0.9	2	4	7	T	T	T
			6	0.5	0.8	1.4	2.3	3.3	T	T	T
			8	0.5	0.6	1	1.4	1.8	3.6	5	T
			10	0.5	0.6	1	1.4	1.8	3.6	5	T
			13		0.5	0.8	1.1	1.4	2.4	3.1	4.7
	10	16			0.8	1.1	1.4	2.4	3.1	4.7	
		20				0.8	1	1.6	2	2.9	
		25					1	1.6	2	2.9	
		32						1.5	1.8	2.6	
		40							1.7	2.4	
	50								2		
	63										

E. = Upstream L. = Downstream
T = total selectivity up to breaking capacity of downstream miniature circuit breaker
Selectivity limits are specified in kA

Miniature circuit breaker S400M

Selectivity to Sace Tmax T1

Tmax T1 – @ 230/400V

		S.	T1											
		Version	B, C, N											
		Release	TM											
		I _n [A]	160											
L.	Char.	I _n [A]	16	20	25	32	40	50	63	80	100	125	160	
S400M FS401M FS403M	B	6	5.5	5.5	5.5	5.5	5.5	5.5	5.5	10	10	10	10	
		8		5.5	5.5	5.5	5.5	5.5	5.5	10	10	10	10	
		10			3	3	3	3	4.5	7.5	8.5	10	10	10
		13				3	3	3	4.5	7.5	8.5	10	10	10
		16					3	3	4.5	5	7.5	10	10	10
		20						3	5	6	10	10	10	10
		25							5	6	10	10	10	10
		32									6	7.5	10	10
		40										7.5	10	10
		50											7.5	10
63												10		

Tmax T1 – @ 230/400V

		S.	T1											
		Version	B											
		Release	TM											
		I _n [A]	160											
L.	Char.	I _n [A]	16	20	25	32	40	50	63	80	100	125	160	
S400M FS401M FS403M	C	≤ 2	50	50	50	50	50	50	50	50	50	50	50	50
		3	16	16	16	16	16	16	16	16	16	16	16	16
		4	16	16	16	16	16	16	16	16	16	16	16	16
		6	5.5	5.5	5.5	5.5	5.5	5.5	5.5	16	16	16	16	16
		8		5.5	5.5	5.5	5.5	5.5	5.5	16	16	16	16	16
		10			3	3	3	3	4.5	7.5	8.5	16	16	16
		13				3	3	3	4.5	7.5	8.5	16	16	16
		16					3	3	4.5	5	7.5	16	16	16
		20							3	5	6	16	16	16
		25								5	6	10	10	10
		32									6	7.5	10	10
		40										7.5	10	10
		50											7.5	10
63												10		

Tmax T1 – @ 230/400V

		S.	T1											
		Version	C											
		Release	TM											
		I _n [A]	160											
L.	Char.	I _n [A]	16	20	25	32	40	50	63	80	100	125	160	
S400M FS401M FS403M	C	≤ 2	50	50	50	50	50	50	50	50	50	50	50	50
		3	25	25	25	25	25	25	25	25	25	25	25	25
		4	25	25	25	25	25	25	25	25	25	25	25	25
		6	5.5	5.5	5.5	5.5	5.5	5.5	5.5	25	25	25	25	25
		8		5.5	5.5	5.5	5.5	5.5	5.5	25	25	25	25	25
		10			3	3	3	3	4.5	7.5	8.5	25	25	25
		13				3	3	3	4.5	7.5	8.5	25	25	25
		16					3	3	4.5	5	7.5	25	25	25
		20							3	5	6	25	25	25
		25								5	6	10	10	10
		32									6	7.5	10	10
		40										7.5	10	10
		50											7.5	10
63												10		

E. = Upstream L. = Downstream
T = total selectivity up to breaking capacity of downstream miniature circuit breaker
Selectivity limits are specified in kA

Miniature circuit breaker S400M

Selectivity to Sace Tmax T1

Tmax T1 – @ 230/400V

		S.	T1											
		Version	N											
		Release	TM											
		I _n [A]	160											
L.	Char.	I _n [A]	16	20	25	32	40	50	63	80	100	125	160	
S400M FS401M FS403M	C	≤ 2	50	50	50	50	50	50	50	50	50	50	50	50
		3	25	25	25	25	25	25	25	25	25	25	25	25
		4	25	25	25	25	25	25	25	25	25	25	25	25
		6	5.5	5.5	5.5	5.5	5.5	5.5	5.5	25	25	25	25	25
		8		5.5	5.5	5.5	5.5	5.5	5.5	10	25	25	25	25
		10			3	3	3	3	4.5	7.5	8.5	25	25	25
		13				3	3	3	4.5	7.5	8.5	25	25	25
		16					3	4.5	5	7.5	25	25	25	25
		20						3	5	6	25	25	25	25
		25							5	6	10	10	10	10
		32								6	7.5	10	10	10
		40									7.5	10	10	10
		50										7.5	10	10
		63											7.5	10

Tmax T1 – @ 230/400V

		S.	T1											
		Version	B, C, N											
		Release	TM											
		I _n [A]	160											
L.	Char.	I _n [A]	16	20	25	32	40	50	63	80	100	125	160	
S400M	D	6	5.5	5.5	5.5	5.5	5.5	5.5	5.5	10	10	10	10	10
		8		5.5	5.5	5.5	5.5	5.5	5.5	10	10	10	10	10
		10			3	3	3	3	3	5	8.5	10	10	10
		13				2	2	2	2	3	7.5	10	10	10
		16					2	2	2	3	4.5	8	10	10
		20						2	2.5	4	6.5	11	10	10
		25							2	4	6	9.5	10	10
		32								3	6	9.5	10	10
		40									5	8	10	10
		50										5	9.5	10
63											9.5	10	10	

Tmax T1 – @ 230/400V

		S.	T1											
		Version	B, C, N											
		Release	TM											
		I _n [A]	160											
L.	Char.	I _n [A]	16	20	25	32	40	50	63	80	100	125	160	
S400M	K	≤ 2	16	16	16	16	16	16	16	16	16	16	16	16
		3	16	16	16	16	16	16	16	16	16	16	16	16
		4	16	16	16	16	16	16	16	16	16	16	16	16
		6	5.5	5.5	5.5	5.5	5.5	5.5	5.5	16	16	16	16	16
		8		5.5	5.5	5.5	5.5	5.5	5.5	16	16	16	16	16
		10			3	3	3	3	3	6	8.5	16	16	16
		13				3	3	3	3	4.5	7.5	16	16	16
		16					2	3	3.5	5.5	16	16	16	16
		20						2	3.5	5.5	6.5	16	16	16
		25							2	4.5	6	9.5	10	10
		32								4	6	9.5	10	10
		40									5	8	10	10
		50										6	9.5	10
		63											9.5	10

E. = Upstream L. = Downstream
 T = total selectivity up to breaking capacity of downstream miniature circuit breaker
 Selectivity limits are specified in kA

Miniature circuit breaker S400M

Selectivity to Sace Tmax T1, T2

Tmax T2 – S400M @ 230/400V

		S.	T2																				
		Version	N, S, H, L																				
		Release	TM, M												EL								
		I _n [A]	160																				
L.	Char.	I _n [A]	12.5	16	20	25	32	40	50	63	80	100	125	160	10	25	63	100	160				
S400M	K	≤ 2	25	25	25	25	25	25	25	25	25	25	25	25	25	25	25	25	25	25			
		3	25	25	25	25	25	25	25	25	25	25	25	25	25	25	25	25	25	25	25		
		4	25	25	25	25	25	25	25	25	25	25	25	25	25	25	25	25	25	25	25	25	
		6	5.5	5.5	5.5	5.5	5.5	5.5	5.5	5.5	10	10	10	10	10		25	25	25	25	25	25	
		8			5.5	5.5	5.5	5.5	5.5	5.5	10	10	10	10	10		25	25	25	25	25	25	
		10			3	3	3	3	3	3	10	8.5	10	10	10		25	25	25	25	25	25	
		16					2	3	3	3	4.5	7.5	10	10	10			25	25	25	25	25	
		20					2		3	3.5	5.5	6.5	10	10				25	25	25	25	25	
		25							2	3.5	5.5	6	9.5	10				10	10	10	10	10	
		32										4.5	6	9.5	10				10	10	10	10	10
		40										3	5	8	10					10	10	10	10
		50										2	3	6	9.5					9.5	9.5	9.5	9.5
		63											3		9.5								9.5

Tmax T1 – @ 230/400V

		S.	T1											
		Version	B, C, N											
		Release	TM											
		I _n [A]	160											
L.	Char.	I _n [A]	16	20	25	32	40	50	63	80	100	125	160	
S400M	K	≤ 2	36	36	36	36	36	36	36	36	36	36	36	36
		3	25	25	25	25	25	25	25	25	25	25	25	25
		4	25	25	25	25	25	25	25	25	25	25	25	25
		6	5.5	5.5	5.5	5.5	5.5	5.5	5.5	25	25	25	25	25
		8		5.5	5.5	5.5	5.5	5.5	5.5	10	12	25	25	25
		10			3	3	3	3	3	6	8.5	25	25	25
		13				3	3	3	3	4.5	7.5	25	25	25
		16					2	3	3.5	5.5	25	25	25	25
		20						2	3.5	5.5	6.5	11	25	25
		25							2	4.5	6	9.5	10	10
		32									4	6	9.5	10
		40										5	8	10
		50											6	9.5
		63												9.5

E. = Upstream L. = Downstream
T = total selectivity up to breaking capacity of downstream miniature circuit breaker
Selectivity limits are specified in kA

Miniature circuit breaker S400M

Selectivity to Sace Tmax T2

Tmax T2 – S400M @ 230/400V

		S.	T2																		
		Version	N, S, H, L																		
		Release	TM, M												EL						
		I _n [A]	160																		
L.	Char.	I _n [A]	12.5	16	20	25	32	40	50	63	80	100	125	160	10	25	63	100	160		
S400M FS401M FS403M	B	6	5.5	5.5	5.5	5.5	5.5	5.5	5.5	5.5	10	10	10	10	10		10	10	10	10	
		8			5.5	5.5	5.5	5.5	5.5	5.5	10	10	10	10	10		10	10	10	10	
		10			3	3	3	3	3	4.5	7.5	8.5	10	10	10		10	10	10	10	
		13			3			3	3	4.5	7.5	7.5	10	10	10		10	10	10	10	
		16						3	3	4.5	5	7.5	10	10	10			10	10	10	
		20						3			3	5	6	10	10	10			10	10	10
		25									3	5	6	10	10	10			10	10	10
		32									3		6	7.5	10	10			10	10	10
		40											5.5	7.5	10	10				10	10
		50											3	5	7.5	10				10	10
63												5		10					10		

		S.	T2																		
		Version	N																		
		Release	TM, M												EL						
		I _n [A]	160																		
L.	Char.	I _n [A]	12.5	16	20	25	32	40	50	63	80	100	125	160	10	25	63	100	160		
S400M FS401M FS403M	C	≤ 2	36	36	36	36	36	36	36	36	36	36	36	36	36	36	36	36	36	36	
		3	25	25	25	25	25	25	25	25	25	25	25	25	25	25	25	25	25	25	
		4	25	25	25	25	25	25	25	25	25	25	25	25	25	25	25	25	25	25	
		6	5.5	5.5	5.5	5.5	5.5	5.5	5.5	5.5	25	25	25	25	25		25	25	25	25	
		8			5.5	5.5	5.5	5.5	5.5	5.5	25	25	25	25	25		25	25	25	25	
		10			3	3	3	3	3	4.5	7.5	8.5	10	25	25		25	25	25	25	
		13			3			3	3	4.5	7.5	7.5	10	25	25		25	25	25	25	
		16						3	3	4.5	5	7.5	10	25	25			25	25	25	
		20						3			3	5	6	10	25	25			25	25	25
		25									3	5	6	10	10	10			10	10	10
		32									3		6	7.5	10	10			10	10	10
		40											5.5	7.5	10	10				10	10
		50											3	5	7.5	10				10	10
63												5		10					10		

		S.	T2																		
		Version	S, H, L																		
		Release	TM, M												EL						
		I _n [A]	160																		
L.	Char.	I _n [A]	12.5	16	20	25	32	40	50	63	80	100	125	160	10	25	63	100	160		
S400M FS401M FS403M	C	≤ 2	50	50	50	50	50	50	50	50	50	50	50	50	50	50	50	50	50	50	
		3	25	25	25	25	25	25	25	25	25	25	25	25	25	25	25	25	25	25	
		4	25	25	25	25	25	25	25	25	25	25	25	25	25	25	25	25	25	25	
		6	5.5	5.5	5.5	5.5	5.5	5.5	5.5	5.5	25	25	25	25	25		25	25	25	25	
		8			5.5	5.5	5.5	5.5	5.5	5.5	25	25	25	25	25		25	25	25	25	
		10			3	3	3	3	3	4.5	7.5	8.5	25	25	25		25	25	25	25	
		13			3			3	3	4.5	7.5	7.5	25	25	25		25	25	25	25	
		16						3	3	4.5	5	7.5	25	25	25			25	25	25	
		20						3			3	5	6	10	10	10			25	25	25
		25									3	5	6	10	10	10			10	10	10
		32									3		6	7.5	10	10			10	10	10
		40											5.5	7.5	10	10				10	10
		50											3	5	7.5	10				10	10
63												5		10					10		

S. = Upstream

L. = Downstream

T = total selectivity up to breaking capacity of downstream miniature circuit breaker
Selectivity limits are specified in kA

Miniature circuit breaker S400M

Selectivity to Sace Tmax T2

Tmax T2 – S400M @ 230/400V

		S.	T2																		
		Version	N, S, H, L																		
		Release	TM, M												EL						
		I _n [A]	160																		
L.	Char.	I _n [A]	12.5	16	20	25	32	40	50	63	80	100	125	160	10	25	63	100	160		
S400M	D	6	5.5	5.5	5.5	5.5	5.5	5.5	5.5	5.5	10	10	10	10	10		10	10	10	10	
		8			5.5	5.5	5.5	5.5	5.5	5.5	10	10	10	10	10		10	10	10	10	10
		10			3	3	3	3	3	3	5	8.5	10	10	10		10	10	10	10	10
		16						2	2	2	3	5	8	10	10			10	10	10	10
		20						2		2	3	4.5	6.5	10	10			10	10	10	10
		25								2	2.5	4	6	9.5	10			10	10	10	10
		32										4	6	9.5	10			10	10	10	10
		40										3	5	8	10				10	10	10
		50										2	3	5	9.5				9.5	9.5	9.5
		63											3		9.5						9.5

		S.	T2																		
		Version	N																		
		Release	TM, M												EL						
		I _n [A]	160																		
L.	Char.	I _n [A]	12.5	16	20	25	32	40	50	63	80	100	125	160	10	25	63	100	160		
S400M	K	≤ 2	36	36	36	36	36	36	36	36	36	36	36	36	36	36	36	36	36	36	
		3	25	25	25	25	25	25	25	25	25	25	25	25	25	25	25	25	25	25	25
		4	25	25	25	25	25	25	25	25	25	25	25	25	25	25	25	25	25	25	25
		6	5.5	5.5	5.5	5.5	5.5	5.5	5.5	5.5	25	25	25	25	25		25	25	25	25	25
		8			5.5	5.5	5.5	5.5	5.5	5.5	25	25	25	25	25		25	25	25	25	25
		10			3	3	3	3	3	3	25	8.5	25	25	25		25	25	25	25	25
		16					2	3	3	4.5	7.5	25	25	25	25			25	25	25	25
		20					2		3	3.5	5.5	6.5	25	25	25			25	25	25	25
		25							2	3.5	5.5	6	9.5	10	10			10	10	10	10
		32										4.5	6	9.5	10			10	10	10	10
		40										3	5	8	10				10	10	10
		50										2	3	6	9.5				9.5	9.5	9.5
		63											3		9.5						9.5

		S.	T2																		
		Version	S, H, L																		
		Release	TM, M												EL						
		I _n [A]	160																		
L.	Char.	I _n [A]	12.5	16	20	25	32	40	50	63	80	100	125	160	10	25	63	100	160		
S400M	K	≤ 2	50	50	50	50	50	50	50	50	50	50	50	50	50	50	50	50	50	50	
		3	25	25	25	25	25	25	25	25	25	25	25	25	25	25	25	25	25	25	25
		4	25	25	25	25	25	25	25	25	25	25	25	25	25	25	25	25	25	25	25
		6	5.5	5.5	5.5	5.5	5.5	5.5	5.5	5.5	25	25	25	25	25		25	25	25	25	25
		8			5.5	5.5	5.5	5.5	5.5	5.5	25	25	25	25	25		25	25	25	25	25
		10			3	3	3	3	3	3	10	8.5	25	25	25		25	25	25	25	25
		16					2	3	3	4.5	7.5	25	25	25	25			25	25	25	25
		20					2		3	3.5	5.5	6.5	25	25	25			25	25	25	25
		25							2	3.5	5.5	6	9.5	10	10			10	10	10	10
		32										4.5	6	9.5	10			10	10	10	10
		40										3	5	8	10				10	10	10
		50										2	3	6	9.5				9.5	9.5	9.5
		63											3		9.5						9.5

S. = Upstream

L. = Downstream

T = total selectivity up to breaking capacity of downstream miniature circuit breaker
Selectivity limits are specified in kA

Miniature circuit breaker S400M

Selectivity to Sace Tmax T3

Tmax T3 – S400M, 230/400V

		S.	T3						
		Version	N, S						
		Release	TM, M						
		I _n [A]	250						
L.	Char.	I _n [A]	63	80	100	125	160	200	250
S400M FS401M FS403M	B	6	10	10	10	10	10	10	10
		8	10	10	10	10	10	10	10
		10	7.5	8.5	10	10	10	10	10
		13	7.5	7.5	10	10	10	10	10
		16	5	7.5	10	10	10	10	10
		20	5	6	10	10	10	10	10
		25	5	6	10	10	10	10	10
		32		6	7.5	10	10	10	10
		40			7.5	10	10	10	10
		50			5	7.5	10	10	10
		63			5	6	10	10	10

Tmax T3 – S400M, 230/400V

		S.	T3						
		Version	N, S						
		Release	TM, M						
		I _n [A]	250						
L.	Char.	I _n [A]	63	80	100	125	160	200	250
S400M	D	6	10	10	10	10	10	10	10
		8	10	10	10	10	10	10	10
		10	5	8.5	10	10	10	10	10
		16	3	5	8	10	10	10	10
		20	3	4.5	6.5	10	10	10	10
		25	2.5	4	6	9.5	10	10	10
		32		4	6	9.5	10	10	10
		40			5	8	10	10	10
		50			3	5	9.5	10	10
		63			3	5	9.5	10	10

		S.	T3						
		Version	N						
		Release	TM, M						
		I _n [A]	250						
L.	Char.	I _n [A]	63	80	100	125	160	200	250
S400M FS401M FS403M	C	≤ 2	36	36	36	36	36	36	36
		3	25	25	25	25	25	25	25
		4	25	25	25	25	25	25	25
		6	25	25	25	25	25	25	25
		8	25	25	25	25	25	25	25
		10	7.5	8.5	25	25	25	25	25
		13	7.5	7.5	25	25	25	25	25
		16	5	7.5	25	25	25	25	25
		20	5	6	25	25	25	25	25
		25	5	6	10	10	10	10	10
		32		6	7.5	10	10	10	10
		40			7.5	10	10	10	10
		50			5	7.5	10	10	10
63			5	6	10	10	10		

		S.	T3						
		Version	N						
		Release	TM, M						
		I _n [A]	250						
L.	Char.	I _n [A]	63	80	100	125	160	200	250
S400M	K	≤ 2	36	36	36	36	36	36	36
		3	25	25	25	25	25	25	25
		4	25	25	25	25	25	25	25
		6	25	25	25	25	25	25	25
		8	25	25	25	25	25	25	25
		10	25	25	25	25	25	25	25
		16	4.5	7.5	10	25	25	25	25
		20	4.5	5.5	6.5	25	25	25	25
		25	3.5	5.5	6	9.5	10	10	10
		32		4.5	6	9.5	10	10	10
		40			5	8	10	10	10
		50			3	6	9.5	10	10
		63			3	5.5	9.5	10	10

		S.	T3						
		Version	S						
		Release	TM, M						
		I _n [A]	250						
L.	Char.	I _n [A]	63	80	100	125	160	200	250
S400M FS401M FS403M	C	≤ 2	50	50	50	50	50	50	50
		3	25	25	25	25	25	25	25
		4	25	25	25	25	25	25	25
		6	25	25	25	25	25	25	25
		8	25	25	25	25	25	25	25
		10	7.5	8.5	25	25	25	25	25
		13	7.5	7.5	25	25	25	25	25
		16	5	7.5	25	25	25	25	25
		20	5	6	25	25	25	25	25
		25	5	6	10	10	10	10	10
		32		6	7.5	10	10	10	10
		40			7.5	10	10	10	10
		50			5	7.5	10	10	10
63			5	6	10	10	10		

		S.	T3						
		Version	S						
		Release	TM, M						
		I _n [A]	250						
L.	Char.	I _n [A]	63	80	100	125	160	200	250
S400M	K	≤ 2	50	50	50	50	50	50	50
		3	25	25	25	25	25	25	25
		4	25	25	25	25	25	25	25
		6	25	25	25	25	25	25	25
		8	25	25	25	25	25	25	25
		10	25	25	25	25	25	25	25
		16	4.5	7.5	10	25	25	25	25
		20	4.5	5.5	6.5	25	25	25	25
		25	3.5	5.5	6	9.5	10	10	10
		32		4.5	6	9.5	10	10	10
		40			5	8	10	10	10
		50			3	6	9.5	10	10
		63			3	5.5	9.5	10	10

S. = Upstream

L. = Downstream

T = total selectivity up to breaking capacity of downstream miniature circuit breaker
Selectivity limits are specified in kA

Miniature circuit breaker 10 kA S400M

Selectivity to Sace Tmax T4

Tmax T4 – S400M, 400/415V

		S.	T4													
		Version	N, S, H, L, V													
		Release	TM, M										EL			
		I _n [A]	250										250		320	
L.	Char.	I _n [A]	20	25	32	50	80	100	125	160	200	250	100	160	250	320
S400M FS401M FS403M	B	6	7.5	7.5	7.5	7.5	10	10	10	10	10	10	10	10	10	10
		8	7.5	7.5	7.5	7.5	10	10	10	10	10	10	10	10	10	10
		10	5	5	5	6.5	9	10	10	10	10	10	10	10	10	10
		13		5	5	6.5	8	10	10	10	10	10	10	10	10	10
		16		5	5	6.5	8	10	10	10	10	10	10	10	10	10
		20				5	7.5	10	10	10	10	10	10	10	10	10
		25				5	7.5	10	10	10	10	10	10	10	10	10
		32				5	7.5	10	10	10	10	10	10	10	10	10
		40					6.5	10	10	10	10	10	10	10	10	10
		50					5	10	10	10	10	10	10	10	10	10
		63						10	10	10	10	10	10	10	10	10
S400M FS401M FS403M	C	≤ 2	50	50	50	50	50	50	50	50	50	50	50	50	50	50
		3	50	50	50	50	50	50	50	50	50	50	50	50	50	
		4	50	50	50	50	50	50	50	50	50	50	50	50	50	
		6	7.5	7.5	7.5	7.5	50	50	50	50	50	50	50	50	50	
		8	7.5	7.5	7.5	7.5	50	50	50	50	50	50	50	50	50	
		10	5	5	5	6.5	9	50	50	50	50	50	50	50	50	
		13		5	5	6.5	8	50	50	50	50	50	50	50	50	
		16		5	5	6.5	8	50	50	50	50	50	50	50	50	
		20				5	7.5	50	50	50	50	50	50	50	50	
		25				5	7.5	10	10	10	10	10	10	10	10	
		32				5	7.5	10	10	10	10	10	10	10	10	
40					6.5	10	10	10	10	10	10	10	10			
50					5	10	10	10	10	10	10	10	10			
63						10	10	10	10	10	10	10	10			
S400M	D	≤ 2	10	10	10	10	10	10	10	10	10	10	10	10	10	
		3	10	10	10	10	10	10	10	10	10	10	10	10		
		4	10	10	10	10	10	10	10	10	10	10	10	10		
		6	7.5	7.5	7.5	7.5	10	10	10	10	10	10	10	10		
		8	7.5	7.5	7.5	7.5	10	10	10	10	10	10	10	10		
		10	5	5	5	5	9	10	10	10	10	10	10	10		
		16				4	5.5	10	10	10	10	10	10	10		
		20				4	5	10	10	10	10	10	10	10		
		25				4	4.5	10	10	10	10	10	10	10		
		32					4.5	10	10	10	10	10	10	10		
		40					4.5	10	10	10	10	10	10	10		
50						10	10	10	10	10	10	10				
63							10	10	10	10	10	10				
S400M	K	≤ 2	50	50	50	50	50	50	50	50	50	50	50	50	50	
		3	50	50	50	50	50	50	50	50	50	50	50	50		
		4	50	50	50	50	50	50	50	50	50	50	50	50		
		6	7.5	7.5	7.5	7.5	50	50	50	50	50	50	50	50		
		8	7.5	7.5	7.5	7.5	50	50	50	50	50	50	50	50		
		10		5	5	5	9	50	50	50	50	50	50	50		
		16		5		5	8	50	50	50	50	50	50	50		
		20				5	6	50	50	50	50	50	50	50		
		25				5	6	10	10	10	10	10	10	10		
		32				5	6	10	10	10	10	10	10	10		
		40					5.5	10	10	10	10	10	10	10		
50					5	10	10	10	10	10	10	10				
63						10	10	10	10	10	10	10				

E. = Upstream L. = Downstream
T = total selectivity up to breaking capacity of downstream miniature circuit breaker
Selectivity limits are specified in kA

Miniature circuit breaker, RCBO

Influence of ambient temperature

Allowable current of miniature circuit breakers and RCBO FS401, FS403 depending on ambient temperature and max. load current for row mounted miniature circuit breakers.

Practical procedure

Conditions often arise which allow for simple consideration of the ambient temperature and thermal influences of row mounted circuit breakers according to EN 60898 and EN 60947-2. The following procedure has proven to be effective:

1. Selection of circuit breaker according to the rated current of the equipment or the current carrying capacity of the cable depending on which of these is the lower value.
2. Consideration of thermal factors
 - for an ambient temperature of 40°C: $I_B \leq 0,9 \times I_n$
 - for thermal influence of row mounted circuit breakers subject to the same loads: $I_B \leq 0,75 \times I_n$
3. This results in the rated current of the circuit breaker to be selected for $I_n \leq 1,5$ times the relevant current according to point 1.

This procedure considers all thermal influence factors and results in an optimum choice of the rated current for the circuit breaker.

Example: Current carrying capacity required of the cable: 4 A. Selected rated current of circuit breaker taking thermal influence into consideration: $I_n \geq 1,5 \times 4 \text{ A} \geq 6 \text{ A}$.

Basis for the simplified procedure

1. Different ambient temperature

The thermal releases are set to a reference ambient temperature. For trip characteristic K, this is 40°C, for trip characteristics B, C and D, this is 30°C. At different ambient temperatures, the specified current values change by around 6% per 10°C difference in temperature.

For more accurate calculations and very high or very low ambient temperatures, the following tables apply:

2. Influence of row mounted devices at continuous load

If the circuit breakers are lined up close to one another and have equally high load levels, a correction factor must be taken. This influence can be reduced if fillers and/or spacers (9 mm wide) are used.

Influence of adjacent devices S400/FS401/FS403

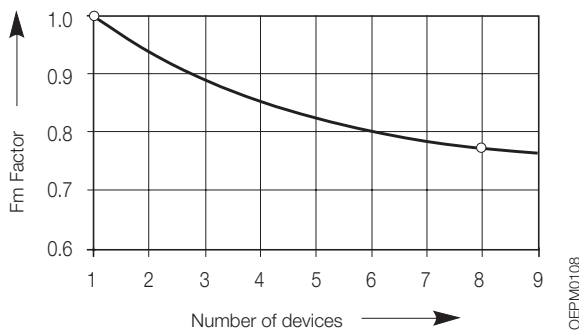

Influence of adjacent devices	
Correction factor Fm	
No. of adjacent devices	correction factor
1	1
2	0.95
3	0.9
4	0.86
5	0.82
6	0.795
7	0.78
8	0.77
9	0.76
>9	0.76

Miniature circuit breaker

Influence of ambient temperature

Max. operating currents depending on ambient temperature for S400 miniature circuit breakers of trip characteristics B, C, D, UC-C and UC-Z

I _n (A)	Ambient temperature T (°C)										
	0	10	15	20	25	30	35	40	45	50	55
0.5*	0.58	0.55	0.53	0.52	0.51	0.50	0.48	0.47	0.46	0.44	0.43
1.0*	1.15	1.09	1.07	1.04	1.02	1.0	0.97	0.94	0.91	0.89	0.86
1.6*	1.85	1.75	1.71	1.67	1.63	1.6	1.55	1.50	1.46	1.42	1.38
2.0*	2.31	2.19	2.13	2.08	2.03	2.0	1.93	1.88	1.83	1.77	1.72
3.0*	3.5	3.32	3.24	3.16	3.09	3.0	2.93	2.85	2.77	2.69	2.61
4.0*	4.6	4.37	4.27	4.17	4.07	4.0	3.86	3.76	3.66	3.56	3.45
6.0	6.9	6.59	6.44	6.29	6.14	6.0	5.83	5.68	5.53	5.37	5.22
8.0	9.2	8.84	8.63	8.42	8.22	8.0	7.81	7.6	7.39	7.19	6.98
10.0	11.5	10.9	10.7	10.4	10.2	10.0	9.65	9.39	9.14	8.88	8.63
13.0	15.0	14.4	14.0	13.7	13.3	13.0	12.7	12.3	12.0	11.6	11.3
16.0	18.5	17.6	17.2	16.8	16.4	16.0	15.6	15.2	14.7	14.3	13.9
20.0	23.1	22.1	21.6	21.0	20.5	20.0	19.5	19.0	18.5	18.0	17.5
25.0	28.9	27.5	26.9	26.3	25.6	25.0	24.3	23.7	23.0	22.4	21.8
32.0	37.0	35.3	34.5	33.7	32.8	32.0	31.2	30.4	29.5	28.7	27.9
40.0	46.2	44.1	43.0	42.0	41.0	40.0	39.0	37.9	36.9	35.9	34.9
50.0	57.7	55	53.7	52.4	51.1	50.0	48.6	47.3	46.0	44.7	43.4
63.0	72.7	69.3	67.7	66.1	64.5	63.0	61.3	59.7	58.1	56.4	54.8

* only applies to C

Max. operating currents depending on ambient temperature for S400 miniature circuit breakers of trip characteristic K

I _n (A)	Ambient temperature T (°C)										
	10	15	20	25	30	35	40	45	50	55	
0.5	0.54	0.52	0.51	0.50	0.49	0.47	0.5	0.45	0.43	0.42	
1.0	1.14	1.12	1.09	1.07	1.0	1.02	1.0	0.96	0.94	0.91	
1.6	1.85	1.81	1.77	1.73	1.7	1.65	1.6	1.56	1.52	1.48	
2.0	2.29	2.23	2.18	2.13	2.1	2.03	2.0	1.93	1.87	1.82	
3.0	3.48	3.40	3.32	3.25	3.2	3.09	3.0	2.93	2.85	2.77	
4.0	4.58	4.48	4.38	4.28	4.2	4.07	4.0	3.87	3.77	3.66	
6.0	6.91	6.76	6.61	6.46	6.3	6.15	6.0	5.85	5.69	5.54	
8.0	9.24	9.03	8.82	8.62	8.4	8.21	8.0	7.79	7.59	7.38	
10.0	11.5	11.2	11.0	10.7	10.5	10.2	10.0	9.69	9.43	9.18	
13.0	15.1	14.7	14.4	14.0	13.7	13.4	13.0	12.7	12.3	12.0	
16.0	18.4	18.0	17.6	17.2	16.8	16.4	16.0	15.6	15.2	14.8	
20.0	23.0	22.5	22.0	21.5	20.9	20.4	20.0	19.4	18.9	18.4	
25.0	28.9	28.3	27.6	27.0	26.3	25.7	25.0	24.4	23.8	23.1	
32.0	36.9	36.1	35.3	34.4	33.6	32.8	32.0	31.1	30.3	29.5	
40.0	46.2	45.1	44.1	43.1	42.1	41.1	40.0	39.0	38.0	37.0	
50.0	57.7	56.4	55.1	53.8	52.5	51.3	50.0	48.7	47.4	46.1	
63.0	72.5	70.9	69.3	67.7	66.1	64.5	63.0	61.3	59.6	58.0	

Miniature circuit breaker

Protection of circuits with fluorescent lamps

Protection of circuits with fluorescent lamps

The following table gives the maximum permissible number of fluorescent lamps which can be protected by a single-pole circuit breaker of characteristic. The figure for multi-pole circuit breakers is reduced by 20%.

Rated current	FL not compensated			FL compensated in parallel			FL with electronic ballast		
	KVG			KVG			EVG ¹⁾		
	18/20 W	36/40 W	58/65 W	18/20 W	36/40 W	58/65 W	18/20 W	36/40 W	58/65 W
13	35	30	19	41	41	27	21	21	10
16	43	37	24	51	51	33	26	26	12
20	53	46	30	64	64	41	33	33	15
25	66	58	37	82	82	53	42	42	19

¹⁾ EVG: Two-lamp version, lamps switched together, electronic ballast
KVG: Conventional ballast

Use of miniature circuit breakers S400 M for DC systems

A standard miniature circuit breaker type S400 M and S400 E can be used in a DC system by observing the following conditions: Single pole miniature circuit breaker max. 60 VDC. 2-pole miniature circuit breaker with 2-poles in series max. 125 VDC. The polarity needs not to be taken into account. Load connection can either be at the top or at the bottom of the MCB.

Example of permissible DC voltages depending on the number of poles and the circuit configuration in earthed DC systems:

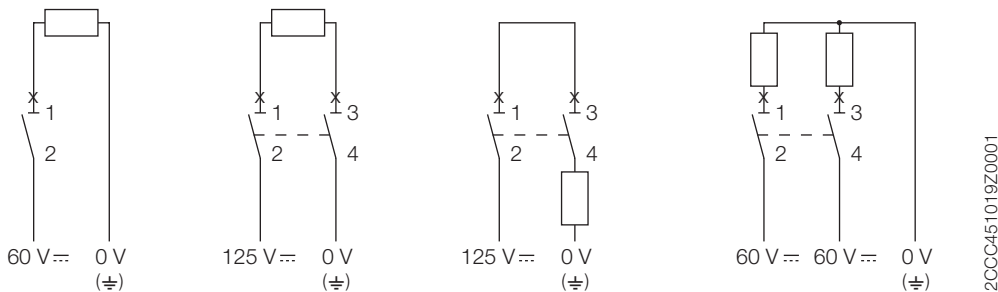

Example of permissible DC voltages depending on the number of poles in unearthed DC systems:

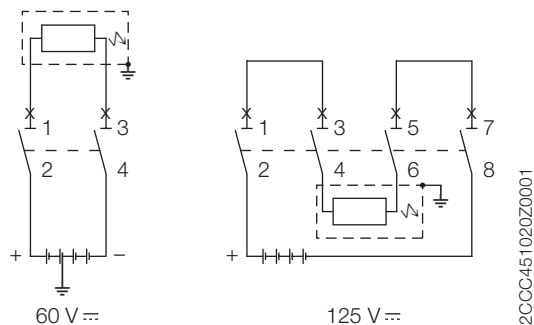

Miniature circuit breaker S400UC

UC = Universal Current = AC/DC

S400UC MCBs can be used in the one-pole version as 125 V d.c., and in the 2-pole version with series connection of two poles up to 250 V d.c..

For DC incoming supply from above

S400 UC-... MCBs have, in the area of arc chutes, permanent magnets, it is therefore necessary to take into account the polarity during the installation process. Doing so ensures that in the case of a short circuit the magnetic field of the permanent magnets corresponds with the electromagnetic field of the short-circuit current, therefore safely leading the short circuit into the arc chute. Incorrect polarities may cause damage to the MCB. **This is why – in the case of top-fed devices – terminal 1 must be connected to (-) and terminal 3 (+).**

Example for permissible voltages between the conductors depending on the number of poles and circuit layout:

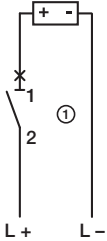
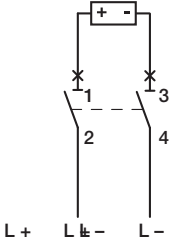
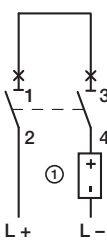
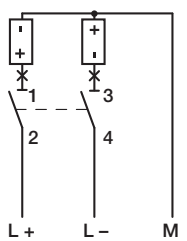
voltage U_N				
between conductors	125 V d.c.	250 V d.c.	250 V d.c.	250 V d.c.
voltage U_N				
between conductor and earth supply	125 V d.c.	125 V d.c.	250 V d.c.	125 V d.c.
				

Residual current operated circuit breaker F402, F404

Properties



2CCC451365F0001

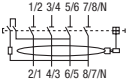

2CCC451365Z0001

General information about residual current operated circuit breakers

The residual current operated circuit breaker prevents personal injury and damage to property caused by electric current. Use of this circuit breaker is required in various national and international standards for electrical installations.

Modern residual current operated circuit breakers respond to small residual currents. Interruption occurs in a fraction of a second even before a hazardous situation for people, animals and property can arise.

The principle of magnetic tripping independent of the supply voltage ensures perfect and safe operation even in the event of undervoltage and neutral interruptions.







The key features

- High short-circuit resistance 10 kA
- Sensitive for alternating and pulsating DC residual currents
- 2- and 4-pole types
- Nominal residual trip currents 10, 30, 100, 300 and 500 mA
- Snap-on auxiliary switches and signal contacts
- Nominal currents 25, 40, 63 A
- Double terminals

According to the wave form of the earth leakage currents they are sensitive to, the RCDs may be classed as:

- A type (for alternating and/or pulsating current with DC components)
- AC type (for alternating current only)

ABB SMISLINE RCD's are all type A.

Shape of the fault current		Correct RDC function	
		alternating current Type AC	pulsating current sensitiv Type A
sinusoidal a.c.	 rampant		
	 slowly rising		
pulsating d.c.	 rampant with or without overlapping DC components		
	 slowly rising		

2CCC451096Z0001

Selectivity

RCDs raise similar issue to those surrounding the installation of MCBs, and in particular the need to reduce to a minimum the parts of the system out of order in the event of a fault.

For RCBOs the problem of selectivity in the case of short-circuit currents may be handled with the same specific criteria as for MCBs.

However, for correct residual current protection, the more important aspects are linked to tripping times. Protection against contact voltages is only effective if the maximum times indicated on the safety curve are not exceeded.

Residual current operated circuit breaker

Properties

Partial selectivity

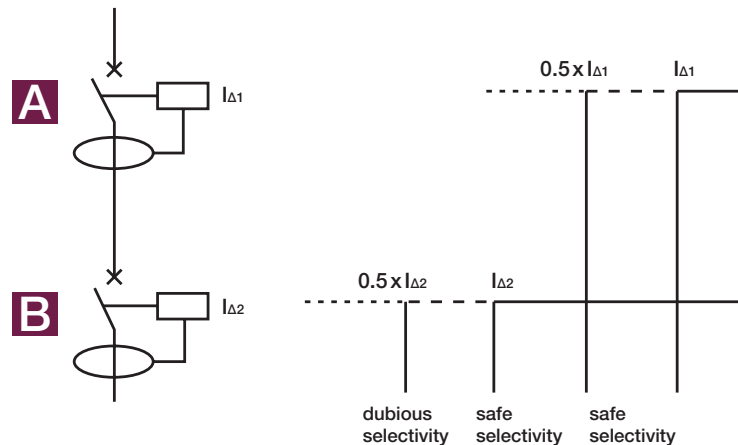

2C0C451087Z0001

Total selectivity

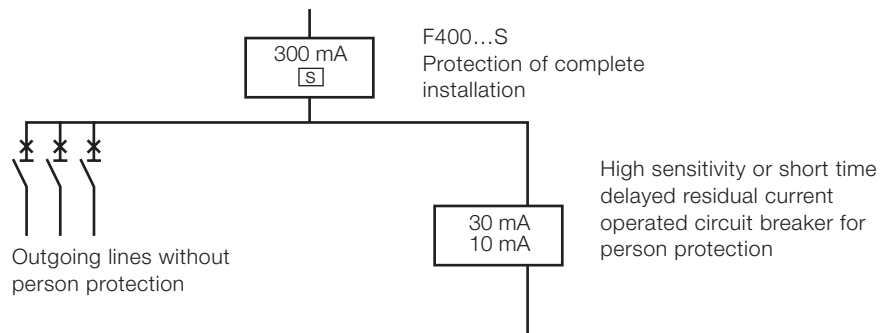

Z20302.eps

Amperometric (partial) selectivity

Selectivity may be created by placing low-sensitivity RCDs upstream and higher-sensitivity RCDs downstream.

An essential condition which must be satisfied in order to achieve selective co-ordination is that the $I_{\Delta 1}$ value of the breaker upstream (main breaker) is more than double the $I_{\Delta 2}$ value of the breaker downstream. The operative rule to obtain an amperometric (partial) selectivity is $I_{\Delta n}$ of the upstream breaker = $3 \times I_{\Delta n}$ of the downstream breaker (e. g.: F404, 300 mA upstream; F402, 100 mA downstream).

In this case, selectivity is partial and only the downstream breaker trips for earth fault currents $I_{\Delta 2} < I_{\Delta m} < 0,5 \times I_{\Delta 1}$.

Chronometric (total) selectivity

To achieve total selectivity, delayed or selective RCDs must be installed.

The tripping times of the two devices connected in series must be co-ordinated so that the total interruption time t_2 of the downstream breaker is less than the upstream breaker's no-response limit time t_1 , for any current value. In this way, the downstream breaker completes its opening before the upstream one.

To completely guarantee total selectivity, the I_{Δ} value of the upstream device must also be more than double that of the downstream device in accordance with IEC 64-8/563.3, comments. The operative rule to obtain an amperometric (partial) selectivity is $I_{\Delta n}$ of the upstream breaker = $3 \times I_{\Delta n}$ of the downstream breaker (e. g.: F404, S type, 300 mA upstream).

For safety reasons, the delayed tripping times of the upstream breaker must always be below the safety curve.

Residual current operated circuit breaker

Standard, short-time delayed and selective type

The use of multiple electronic reactors for the supply of fluorescent lamps instead generates permanent leakage currents and inrush currents that can provoke nuisance tripping of a standard residual current breaker.

IT system loads and other electronic equipment (e.g. dimmers, computers, inverters) with capacitive input filters connected between the phases and ground can also generate permanent earth leakage currents whose sum may provoke the nuisance tripping of a standard residual current breaker.

For these situations, the SHORT-TIME DELAY breakers allow a greater number of devices to be connected to the installation.

Soft-starters for motors are loads which can generate high-frequency capacitive currents (provoked by the harmonics) toward ground or fed into the network. Also in this case, the use of SHORT-TIME DELAY residual breakers reduces the sensibility to nuisance tripping.

Compared with standard type breakers, SHORT-TIME DELAY residual current breakers are therefore characterised, for any given sensibility, by:

- Higher residual trip current
- Tripping time delay
- Better resistance to overvoltages, harmonics and impulse disturbances.

Regulations

The tests set out in the IEC 61008 and IEC 61009 standards verify the resistance of residual current breakers to unwanted tripping provoked by operation overvoltages, using a ring wave impulse shape of $0.5 \mu\text{s}/100 \text{kHz}$. All residual current circuit-breakers are required to pass this test with a peak current value of 200 A.

For what concerns atmospheric overvoltages, the IEC 61008 and 61009 standards prescribe the $8/20 \mu\text{s}$ surge test with a 3000 A peak current, but limit the requirement to residual current devices classified as selective; no test is required for other types.

The ABB range of SHORT-TIME DELAY anti- nuisance tripping breakers and blocks pass the general $0.5 \mu\text{s}/100 \text{kHz}$ ring wave test and also withstand the $8/20 \mu\text{s}$ impulse test with the same peak current of 3000 A prescribed for selective devices.

The F402 K and F404 K should therefore be used to prevent unwanted tripping.

Three different types of Residual current operated circuit breaker

- standard RCD 30 mA
- selective RCD 300 mA [S]
- short-time delay RCD 30 mA [K]

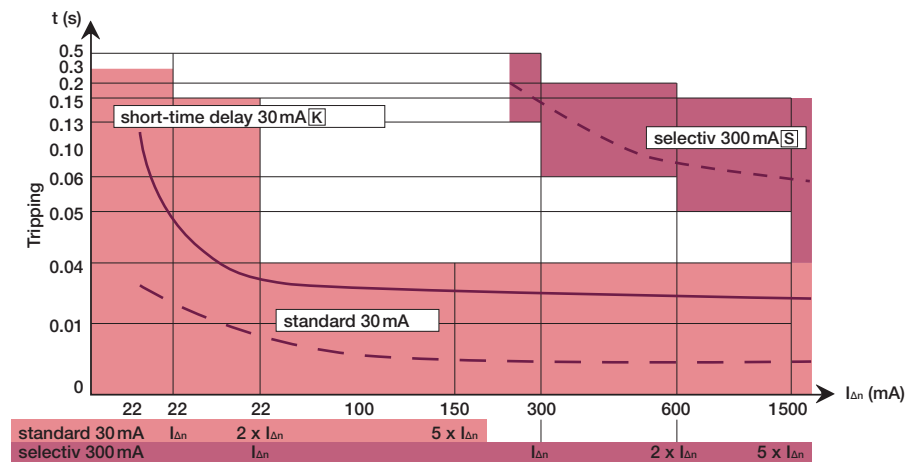

- The standard RCD 30 mA tripp after circa 22 mA and a release time of ≤ 35 ms.
- The selective RCD 300 mA tripp after circa 200 mA and a release time of circa 180 ms.
- The short-time delay RCD 30 mA tripp after circa 25 mA and a release time of 100 ... 120 ms.

Residual current operated circuit breaker

Standard, short-time delayed and selective type

Unwanted tripping

In the event of disturbance in the mains, the RCDs normally present in the system are tripped, breaking the circuit even in the absence of a true earth fault.

Disturbances of this kind are most often caused by:

- operation overvoltages caused by inserting or removing loads (opening or closing protection of control devices, starting and stopping motors, switching fluorescent lighting systems on and off, etc.)
- overvoltages of atmospheric origin, caused by direct or indirect discharges on the electrical line.

Under these circumstances, breaker tripping is unwanted, since it does not satisfy the need to avoid the risks due to direct and indirect contacts. On the contrary, the sudden and unjustified interruption of the power supply may result in very serious problems.

SHORT-TIME DELAY RCDs

The ABB range of SHORT-TIME DELAY anti-disturbance residual current circuitbreakers and blocks was designed to overcome the problem of unwanted tripping due to overvoltages of atmospheric or operation origin.

The electronic circuit in these devices can distinguish between temporary leakage caused by disturbances on the mains and permanent leakage due to actual faults, only breaking the circuit in the latter case.

SHORT-TIME DELAY residual current circuit-breakers and blocks have a slight delay into the tripping time, but this does not compromise the safety limits set by the Standards in force (release time at $2 I_{\Delta n} = 150$ ms).

Guaranteeing conventional residual current protection, their installation in the electrical circuit therefore allows any unwanted tripping to be avoided in domestic and industrial systems in which service continuity is essential.

This delay makes the SHORT-TIME DELAY residual current devices especially suited for installations involving motor starters/variable speed drives, fluorescent lamps or IT/electronic equipment.

Table of RDC selectivity

		Upstream $I_{\Delta n}$ [mA]	10	30	100	300	300	500	500
Downstream $I_{\Delta n}$ [mA]			inst	inst	inst	inst	S	inst	S
10	inst			■	■	■	■	■	■
30	inst				■	■	■	■	■
100	inst					■	■		■
300	inst								
300	S								
500	inst								
500	S								

inst = instantaneous S = selective ■ = amperometric (partial) selectivity ■ = chronometric (total) selectivity

Residual current operated circuit breaker

Technical data

	F402	F404
Rated voltage U_n :	230 V	230/400 V
Number of poles:	2	4
Rated frequency f_n :	50/60 Hz	50/60 Hz (for Type LF 16 ² / ₃ Hz)
Rated breaking capacity I_m :		1000 A
Total trip time (average value)		
– at $I_{\Delta n}$	≤ 300 ms	≤ 300 ms
– at 5 $I_{\Delta n}$	≤ 40 ms	≤ 40 ms
Delay time at 5 $I_{\Delta n}$:	–	–
Resistance to short circuits (kA):	10 kA	10 kA
	in conjunction with an upstream fuse gL / gG 100 A or a high performance MCB S800, 100 A	in conjunction with an upstream fuse gL / gG 100 A or a high performance MCB S800, 100 A
Connection load side terminal	Double lift terminal touch finger-proof, suitable for connecting single-, multi- and fine-wire conductors of up to 25 mm ²	
Degree of protection:	IP20 inside panel IP40	IP20 inside panel IP40
Endurance:	> 5000 operating cycles	> 5000 operating cycles
Resistance to climate acc. to:	EN 61008	EN 61008
Mounting position:	any	any
Ambient temperature:	–25 °C ... +40 °C	–25 °C ... +55 °C acc. to EN 61009
Vibration resistance:	5 g 5 ... 150 ... 5 Hz	5 g 5 ... 150 ... 5 Hz
Plastic parts:	halogen-free	halogen-free
Contacts:	cadmium-free	cadmium-free

	F402...K	F404...K	F404...S
Rated voltage U_n :	230 V	230/400 V	230/400 V
Number of poles:	2	4	4
Rated frequency f_n :	45 ... 60 Hz	45 ... 60 Hz	45 ... 60 Hz
Resistance to surge current:	3 kA 8/20 μs	3 kA 8/20 μs	5 kA 8/20 μs
Total trip time (average value)			
– at $I_{\Delta n}$	240 ms	120 ... 300 ms	150 ... 500 ms
– at 5 $I_{\Delta n}$	≤ 40 ms		40 ... 150 ms
Delay time at 5 $I_{\Delta n}$:	10 ms	10 ms	90 ms
Resistance to short circuits (kA):	10 kA	10 kA	10 kA
	in conjunction with an upstream fuse gL / gG 100 A or a high performance MCB S800 100 A		
Connection load side terminal	Double lift terminal touch finger-proof, suitable for connecting single-, multi- and fine-wire conductors of up to 25 mm ²		
Degree of protection:	IP20 in panel IP40	IP20 in panel IP40	IP20 in panel IP40
Endurance:	> 5000 operating cycles	> 5000 operating cycles	> 5000 operating cycles
Resistance to climate acc. to:	EN 61008	EN 61008	EN 61008
Mounting position:	any	any	any
Ambient temperature:	–25 °C ... +40 °C	–25 °C ... +55 °C	–25 °C ... +40 °C
Vibration resistance:	5 g 5 ... 150 ... 5 Hz	5 g 5 ... 150 ... 5 Hz	5 g 5 ... 150 ... 5 Hz
Plastic parts:	halogen-free	halogen-free	halogen-free
Contacts:	cadmium-free	cadmium-free	cadmium-free

Residual current operated circuit breaker

Technical data

Coordination tables between Short Circuit Protection Devices (SCPD) and F404 RCCBs

If you are using an RCCB you must verify that the Short Circuit Protection Device (SCPD) protects it from the effects of high current that arise under short-circuit conditions. The IEC/EN 61008 provides some tests to verify the behaviour of RCCB in short-circuit conditions. The tables below provide the maximum withstanding short-circuit current expressed in eff. kA for which the RCCBs are protected thanks to the coordination with the SCPD with a rated current (thermal protection) less than or equal to the rated current of the associated RCCB.

	F404 25 A	F404 40 A	F404 63 A
gG fuse 25 A	100		
gG fuse 40 A	60	60	
gG fuse 63 A	40	40	40
gG fuse 100 A	20	20	25
S403M	10	10	10
S803N	20	20	20
S803S	25	25	25

Internal resistances and power losses of RCCBs and RCBOs

Internal resistances and power losses per pole (cold resistance at room temperature)

4-pole RCCB F404

in A	R _i mΩ	P _v W
25	2.1	1.3
40	2.0	3.2
63	1.1	4.4

2-pole RCCB F402

Type	R _i mΩ	P _v W
25 A/10 mA	8.8	5.5
25 A/30 mA	6.1	3.8
40 A/30 mA	5.8	9.3

4-pole RCBO FS403

Type	R _i Ω	P _v W
B10/0.03	45.06	4.5
B13/0.03	43.19	7.3
B16/0.03	28.64	7.3
B20/0.03	22.62	9.0
B25/0.03	16.18	10.1
C10/0.03	42.11	4.5
C13/0.03	43.12	7.3
C16/0.03	28.25	7.2
C20/0.03	24.46	9.8
C25/0.03	16.23	10.1

2-pole RCBO FS401

Type	R _i Ω	P _v W
C10/0.03	0.0170	1.71
C13/0.01	0.0210	3.58
C13/0.03	0.0150	2.55
C16/0.01	0.0130	3.33
C16/0.03	0.0104	2.67
B16/0.03	0.0109	2.45
B13/0.03	0.0150	3.33
C20/0.03	0.0080	3.20
C25/0.03	0.0070	4.38
C32/0.03	0.0054	5.53

Residual current operated circuit breaker FS401



2C0C451364F0002



2C0C451364F0001

Residual current operated circuit breakers with overcurrent protection (RCBO)

The SMISSLINE residual current operated circuit breakers with overcurrent protection (RCBO) are ideal for protecting people and property in all new and existing distribution systems. The combination of standby current and cable protection in one single device greatly simplifies planning and offers cost benefits. Using a RCBO can e.g. satisfy the minimum level of protection required by regulations in an apartment or in a particular distribution system. Should a residual current arise, only the circuit directly affected is switched off while all other circuits remain in operation.

The short time-delayed residual current operated circuit breaker with overcurrent protection FS401 K is a version particularly suited to unfavourable distribution and load situations. Without limiting the personal protection function in any way, the electronic short time delay prevents nuisance tripping which may arise as a result of capacitive discharge currents.

	FS401	FS401K
Rated voltage U_n :	230 V ~	230 V ~
Upstream fuses and Selectivity limits:	For backup and selectivity, the details for the miniature circuit breakers S400 E and S400 M Page 2/19 to 2/36	
Number of poles:	2-pole (1PN)	2-pole (1PN)
Rated frequency f_n :	50/60 Hz	50/60 Hz
Rated breaking capacity I_{en} :	10 kA – 230 V ~ (10–16 A nominal current) 6 kA – 230 V ~ (20–32 A nominal current)	10 kA – 230 V ~ (10–16 A nominal current) 6 kA – 230 V ~ (20 A nominal current)
Current limitation class:	3	3
Total cut-off time (average value) acc. to	EN 61009-1	EN 61009-1
– at I_n	40 ms	240 ms
– at $5 I_{\Delta n}$	25 ms	35 ms
Delay time at $5 I_{\Delta n}$:	–	10 ms
Connection cross-sections	Opposing action stroke clamp on cylinder, touch finger-proof. Suitable for connecting single, multi- and fine-wire conductors of up to 25 mm ²	
Terminal at load end	single, multi- and fine-wire conductors of up to 25 mm ²	
Degree of protection:	IP20 inside panel IP40	IP20 inside panel IP40
Endurance:	> 5000 operating cycles	> 5000 operating cycles
Resistance to climate, acc. to:	EN 61009	EN 61009
Mounting position:	any	any
Ambient temperature:	–25°C ... +40°C	–25°C ... +40°C
Vibration resistance:	5 g 5 ... 150 ... 5 Hz	5 g 5 ... 150 ... 5 Hz
Plastic parts:	halogen-free	halogen-free
Contacts:	cadmium-free	cadmium-free

Please notice:

For the influence of the ambient temperature and the thermal influences of row mounted RCBO's it is necessary to calculate with the same correction factors like with MCB's.

Residual current operated breaker FS403



2CCC451518F0001

4-pole RCBO from the ABB SMISLINE protective devices range

The combination of circuit protection and a residual current protection in one device as 4-pole RCBO simplifies both – planning and installation. It enables you to provide perfect protection in one device. This protection consists of:

- Short circuit protection
- Overload protection
- Residual current protection
- Preventive fire protection

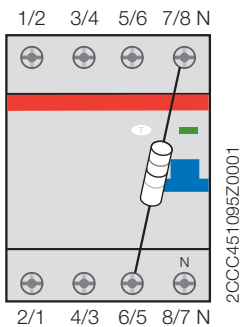

2CCC451095Z0001

High rated short-circuit breaking capacity of 10 kA, conforming to EN 61009-1

The I_{cn} 10 kA short-circuit breaking capacity of the RCBO complies with standard EN 61009-1. This standard specifies testing and usage of RCBO's for household and similar uses. The devices can also be used by non-professionals.

Features and benefits of the new devices:

- Overall width of 72 mm (4 modules)
- Rated sensitivity 30 mA
- Current rating 10 A to 32 A
- B and C tripping characteristics
- Easy Drive double deck terminals on the output side for connecting two conductors in one chamber. The two chambers can accommodate conductors with different cross sections.

	FS403
Rated voltage U_n	230/400V
Number of poles	4
Rated frequency f_n	50/60 Hz
Rated breaking capacity I_{cn}	10 kA (10 A to 16 A) 6 kA (20 A to 25 A)
Current limitation class	3
Total cut-off time acc. to EN 61009	
at I_n	40 ms
at $5x I_n$	25 ms
Connection cross-section	max. 25 mm ² flexible wire with wire end sleeve
Terminal at load side	Possible to connect 2 wires in one chamber. Both chambers could be used with two different cross-sections.
Tightening torque	2.8 Nm
Degree of protection	IP20
Endurance	>5000
Resistance to climate	EN 61009
Ambient temperature	-25°C ... +40°C
Mounting position	any
Vibration resistance	EN 61009
Plastic parts	halogen-free
Contacts	cadmium-free
Standard	EN61009-1, S+ (in preparation)

Accessory:

Auxiliary- and signal contacts are to attach on to the left of the device through the customer.

Please notice:

For the influence of the ambient temperature and the thermal influences of row mounted RCBO's it is necessary to calculate with the same correction factors like with MCBs. Please see page 2/34.

High performance manual motor starter MS325



2CCC451396F0001

General

The MS325 is a circuit breaker with a motor protection characteristic. It is intended above all for industrial applications (MCC) or in distribution systems without a back-up fuse. It also fulfils its traditional function to provide thermal overload protection and short-circuit protection for other sectors of installation technology.

Major features

- Compact design
- Very high rated breaking capacity
- Clear indication of switching position
- Phase failure protection
- Temperature compensation
- Test relase possibility
- Internal, slide-in undervoltage release
- Snap-on auxiliary and signal contact blocks
- Other accessories

	Manual motor starter MS325
Rated voltage U_n :	690 V ~
Rated current I_n (A): (14 adjustment ranges 0.1 ... 25 A):	25
Number of poles:	3
Rated frequency f_n :	50/60 Hz
Rated breaking capacity I_{es} :	100/50 kA
Total disconnection time at short-circuit (50 kA/25 A range):	1.5 ms
Cable cross-section C_u cable or strand	
– at top:	1 x 10 mm ² / 2 x 4 mm ²
– at bottom:	max. 4 mm ²
Degree of protection:	IP20
Endurance:	
– Electrical operations (25 A, AC-3):	100 000
– Mechanical operations:	100 000
Resistance to climate:	IEC/CEI 60068-2-30
Mounting position:	any
Ambient temperature:	–25 °C ... +50 °C
Temperature compensation:	–25 °C ... +50 °C
Vibration resistance:	5 g (50 m/s ²) 5 ... 150 ... 5 Hz
Specifications:	60947-2, 60497-4-1
Plastic parts:	halogen-free
Contacts:	cadmium-free

High performance manual motor starter MS325

Rated-breaking capacity, back-up protection

Thermal release, Adjustment ranges	Magnetic release, Activation current (average value) regardless of thermal setting	Operating breaking capacity I_{cs}			
		230 V~ kA	400 V~ kA	500 V~ kA	690 V~ kA
0.1 – 0.16	1.6	100	100	100	100
0.16 – 0.25	2.5	100	100	100	100
0.25 – 0.4	4	100	100	100	100
0.4 – 0.63	6.3	100	100	100	100
0.63 – 1	12	100	100	100	100
1 – 1.6	19	100	100	100	100
1.6 – 2.5	30	100	100	100	40
2.5 – 4	48	100	100	60	10
4 – 6.3	75	100	100	40	7
6.3 – 9	108	100	100	30	5
9 – 12.5	150	100	75	27	4.5
12.5 – 16	192	100	60	25	4
16 – 20	240	100	55	22	3.5
20 – 25	300	100	50	20	3

Back-up protection

Maximum rated tripping currents

a) If the short-circuit current at the place of installation of the manual motor starter MS325 is no higher than the specified service breaking capacity, a back-up fuse can be omitted. If a back-up fuse is fitted for installation reasons, its rated current may be selected as high as required.

b) If the short-circuit current at the place of installation of the manual motor starter MS325 is higher than its service breaking capacity, the rated current of the back-up fuse must not exceed the value given in the following table.

Thermal release, Adjustment ranges	Magnetic release, Activation current (average value) regardless of thermal setting	Maximum rated tripping current of upstream back-up fuse gL/gG			
		230 V~ kA	400 V~ kA	500 V~ kA	690 V~ kA
0.1 – 0.16	1.6				
0.16 – 0.25	2.5				
0.25 – 0.4	4				
0.4 – 0.63	6.3				
0.63 – 1	12	Short-circuit proof: No back-up fuses needed			
1 – 1.6	19				
1.6 – 2.5	30				25
2.5 – 4	48			40	40
4 – 6.3	75			50	40
6.3 – 9	108			80	50
9 – 12.5	150		80	80	50
12.5 – 16	192		80	100	50
16 – 20	240		100	100	50
20 – 25	300		125	125	50

High performance manual motor starter MS325

DC operating voltages and rated breaking capacities

Internal resistances and power losses of high performance manual motor starter at rated current

Internal resistances and power loss per pole (cold resistance at room temperature)

Adjustment range in A	R_i Ω	P_v W
0.1 – 0.16	71.1	1.8
0.16 – 0.25	27.1	1.7
0.25 – 0.4	12.3	2.0
0.4 – 0.63	5.17	0.8
0.63 – 1	2.09	2.1
1 – 1.6	0.805	0.9
1.6 – 2.5	0.34	2.1
2.5 – 4	0.141	2.3
4 – 6.3	0.051	2.1
6.3 – 9	0.0224	1.8
9 – 12.5	0.0122	1.9
12.5 – 16	0.0081	2.1
16 – 20	0.0048	1.9
20 – 25	0.0035	2.2

Connection of single-phase motors at 230 V~

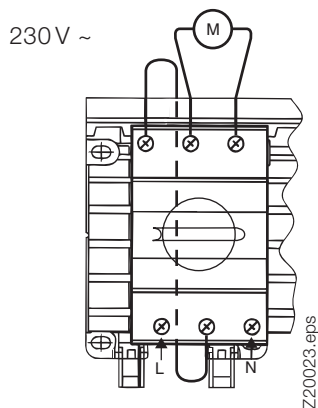

for:

- oil-burner motors
- small fans
- flap motors
- delivery pumps
- special drives
- Batching systems etc.

Manual motor starter ready for installation fitted with special base plate and the corresponding plug-in contacts (L1 and N), in accordance with ordering details, page 1.1/15.

2CCC451016Z0001

Switch disconnecter

Technical data



2CCC451366F0001

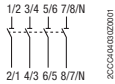

General switch disconnecter

When used in a smissline socket system, the switch disconnecter can be used instead of the incoming terminal block for up to 63 A.

With the smissline IS404 switch disconnecter, individual loads, groups of loads or entire system parts can be separated or connected to the input supply.

The key features of the switch disconnecter

- Input supply switch
- On-Off function
- Clear indication of switching position
- Snap-on auxiliary switch available
- Uniform smissline design

Technical data for switch disconnecter IS404

Rated voltage U_n :	230/400 V ~
Rated current I_n :	63 A
Rated frequency f_n :	50 Hz
Number of poles:	4
Rated impulse withstand voltage:	6 kV
Connection cross-sections C_u :	At top, touch finger-proof. Suitable for connecting up single-, multi- and fine-wire conductors of up to 25 mm ²
Degree of protection:	IP40
Endurance, mechanical/electrical:	5000 operating cycles
Mounting position:	any
Ambient temperature:	-25 °C ... +40 °C
Specifications:	EN/IEC 60947-3
Approvals:	SEV
Weight (approx.):	250 g
Switching duty:	AC-22A
Plastic parts:	halogen-free
Contacts:	cadmium-free

Surge arrester OVR

Properties



2CCC451367F0001

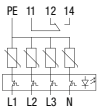

2CCC451367F0001

Description of product

The 'OVR' surge protector is a 4-pole type II surge arrester meeting the requirements of IEC 61643-11.

The OVR is used to protect low voltage distribution systems and devices from overvoltages (DIN VDE 100) caused by remote lightning strikes or switching operations.

Typical sites of use are main and sub-distribution for low voltage systems where the arrester is plugged in directly on to the SMISLINE busbar system.

Display and maintenance

The protective elements (high-performance varistors) are monitored thermally. In the event of a defect, this monitor automatically disconnects the overloaded high-performance varistors from the power supply and the operating indication changes from green to red. This status is also indicated by the signalling contact. In such cases, the arrester should be replaced immediately because the downstream devices are no longer protected against overvoltages.

If the operating indication is neither green nor red, you should check whether the connections are correct. You must also check whether there is any supply voltage.

If the device is connected correctly, the operating display (LED) lights up green.

The surge arrester requires no maintenance. A regular visual check is recommended.

Warning: When taking insulation resistance measurements on the electrical system, the arrester should be disconnected from the power supply since otherwise the measurement may be affected by the arrester characteristics. The enclosed sticker with the corresponding note should be placed in a clear position on the distribution board.

Assembly

Site of installation and electrical connection

The 'OVR' surge arrester installed at the input supply of the system to be protected.

The OVR404 is plugged in directly on to the SMISLINE busbar system.

Earth conductor rating

The OVR should be linked to ground potential using the shortest route possible.

The earth conductor supplied with the device can be used for this purpose. The connection must be as short as possible. The minimum cross-section is 6 mm².

Running cables

Protected and unprotected cables (also including the earth conductor) must not be routed directly parallel to one another. They should be separated such that surge interference from unprotected to protected cables cannot occur. Cables should cross one another at right angles.

Surge arrester OVR Coordination

Coordination between surge arrester

To have a complete protection it is necessary to have coordination between different surge arrester types.

Coordination between OVR type 1 and 2

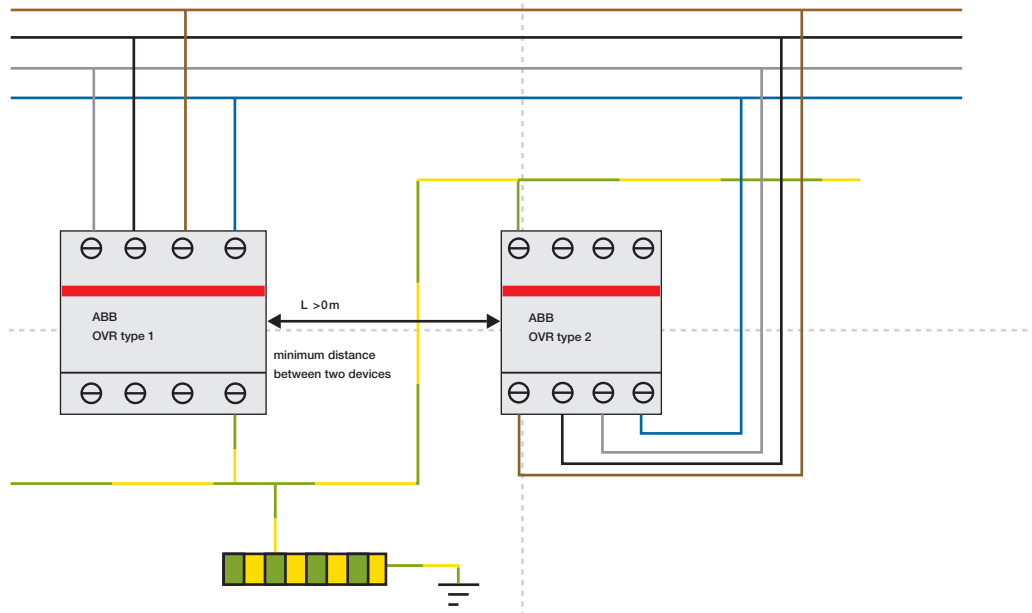

2CCC45109070001

Coordination between OVR type 2

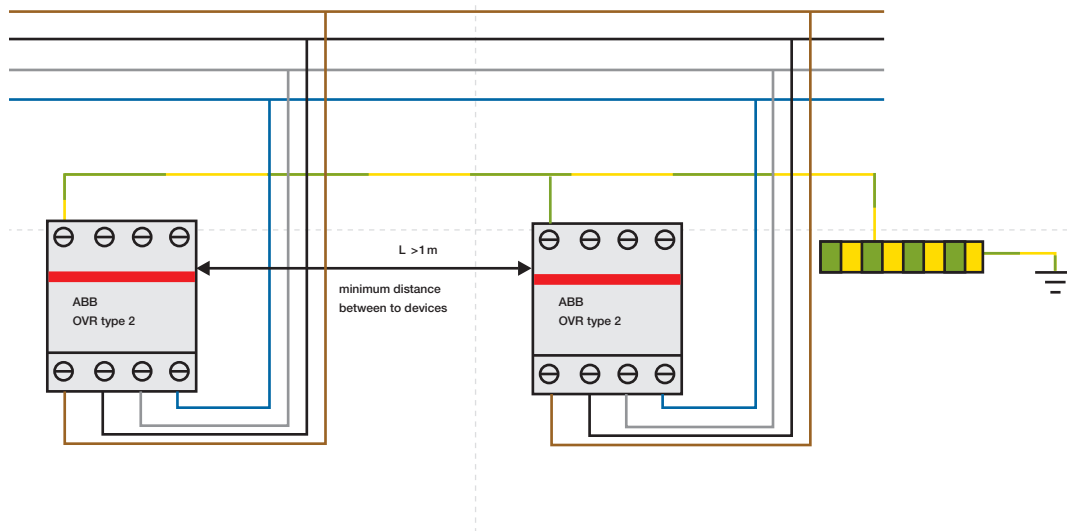

2CCC45109170001

Surge arrester OVR

Technical data

Rated voltage U_n :	230/400 V AC
Max. Continuous voltage U_c :	275 V AC
Number of poles:	4 (TN-S system)
Power consumption at U_n :	1.2 W per device
Requirement class according to IEC 61643-1:	Type 2
Rated leakage surge current I_n (8/20 μ s):	15 kA
Max. leakage surge current I_{smax} (8/20 μ s):	30 kA
Protection level U_p at $I_{sn} \leq 1.5$ kV	
U_p at $I_s = 5$ kV:	≤ 1 kV
Max. leakage surge current I_{sg} (8/20 μ s):	100 kA 4-pole
Response time t_a :	≤ 25 ms
Connection cross-sections PE / L1/L2/L3/N:	Opposing action stroke clamp on cylinder, touch finger-proof. Suitable for connecting up single-, multi- and fine-wire conductors up to 25 mm ²
Max. Back-up fuse:	160 A gL/gG / 25 kA
Short-circuit withstandability with max. Back-up fuse:	25 kA
Signal contact max. operating voltage:	250 V AC
max. load current:	2 A
1 changeover contact:	11/12 normally closed contact, 11/14 normally open contact
Temperature range:	-25 ... +60 °C
Degree of protection:	IP 20
Plastic parts:	halogen-free
Contacts:	cadmium-free

Surge protection TN-S system

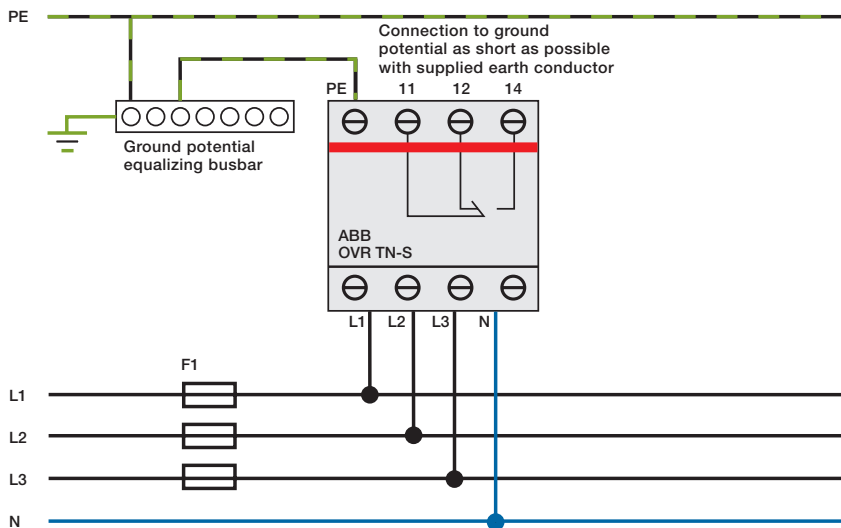

2CCC451017Z0001

Auxiliary switches and signal contacts

Description, Technical data



General

The auxiliary switches and signal contacts are snapped on to the left of the protective devices. On the miniature circuit breakers an optional mounting on the right is also possible. For auxiliary switches and signal contacts supplied via SMISLINE auxiliary busbars LA or LB a version with integrated contacting pieces is available. Conventional supply via the terminals of the auxiliary devices is possible.

Function

The auxiliary switch works in the same way as the main contacts. The signal contact only operates when the protective device trips. This can be simulated with the white test button. Each time the signal contact is tripped, it must be reset to its starting position using the orange-coloured reset button. Auxiliary switch and signal contacts have special contacts which ensure high switching reliability even in systems with low voltages or low currents (PLC, signal systems etc.).



Auxiliary switch contacts operate at the same time as the contacts of the protective device (activated manually or automatically).

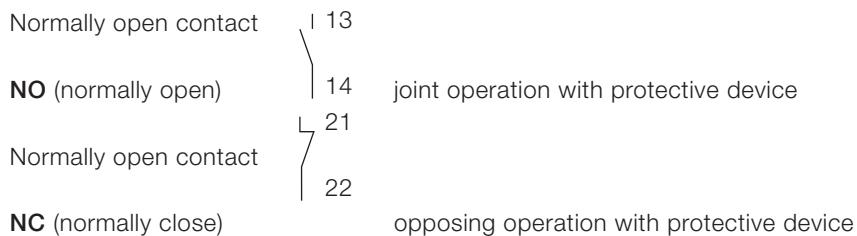

Signal contacts only operate when the protective device is tripped electrically as a result of a short-circuit, a fault current or overcurrent (undervoltage for MS325).

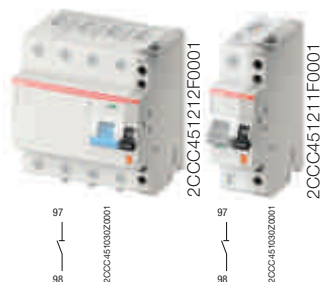
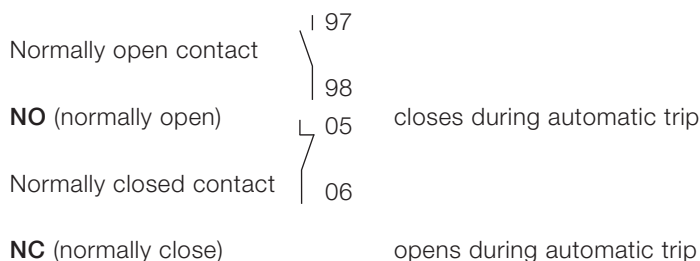

Technical data for auxiliary switch and signal contact

	Signal contact SK400	Auxiliary switch HK400
Rated voltage U_n :	400 V	400 V
Rated impulse withstand voltage:	4 kV	4 kV
Rated current:		
– I_{th} :	6 A	6 A
– AC15	2 A/230 V / 1 A/400 V	2 A/230 V / 1 A/400 V
– DC13	0.55 A/125 V=	0.55 A/125 V=
– DC13	0.27 A/250 V=	0.27 A/250 V=
Minimum current/voltage:	10 mA 12 V=	10 mA 12 V=
(to ensure reliable electrical operation)		
Connection cross-sections:	2 x 1.5 mm ² strand with sleeve	2 x 1.5 mm ² strand with sleeve
Plastic parts:	Free of halogen und cadmium	Free of halogen und cadmium
Internal resistance R_i :	0.0065 Ω	0.0065 Ω
Power loss at rated current P_v :	0.24 W	0.24 W
Ambient temperature:	$T_{max.} +55^\circ\text{C}$ $T_{min.} -25^\circ\text{C}$	$T_{max.} +55^\circ\text{C}$ $T_{min.} -25^\circ\text{C}$
Anzugsdrehmoment Klemmen:	1 Nm	1 Nm

Accessory mounting

Options for protective devices

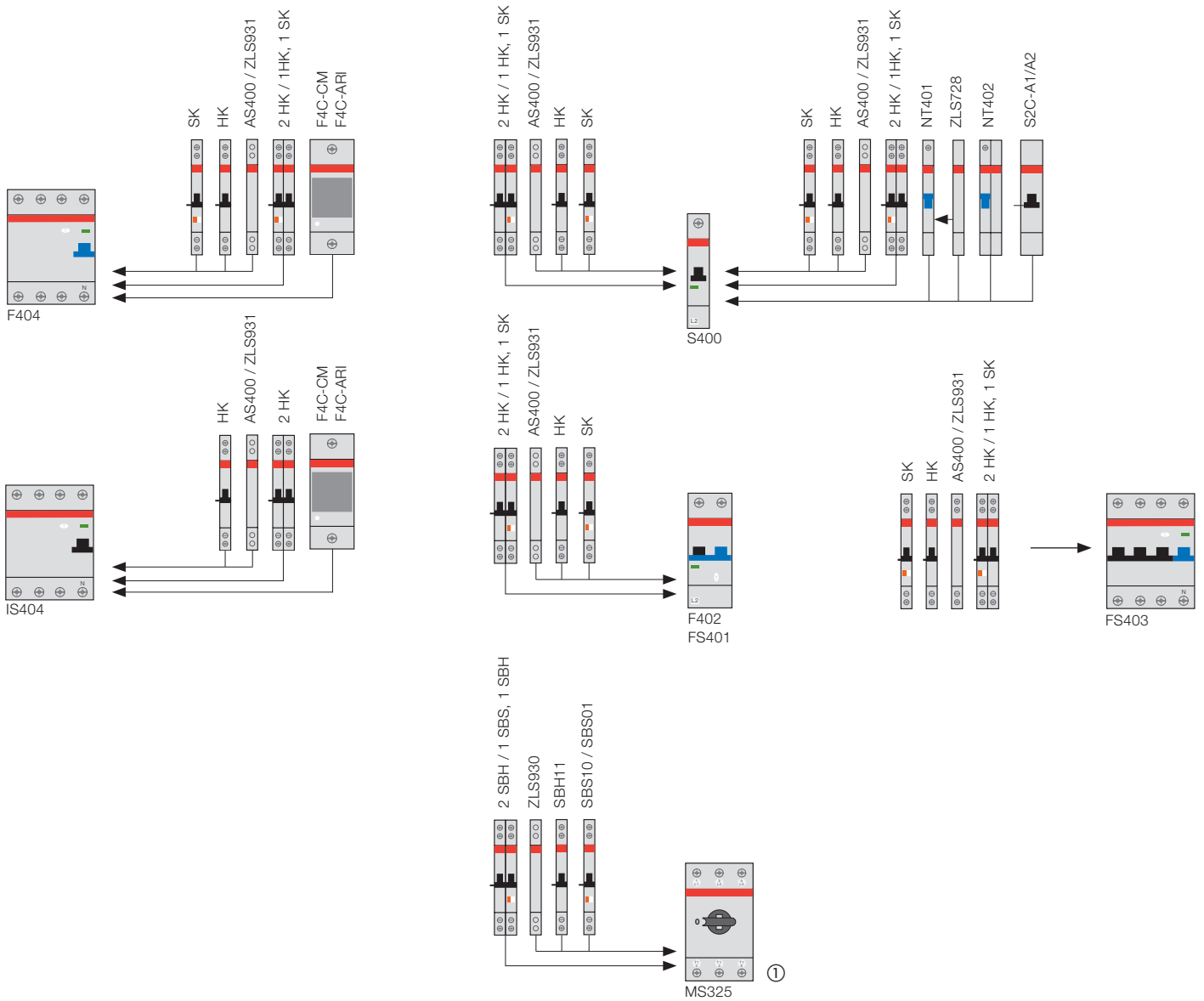

On each protective device can be mounted:

- 1 auxiliary switch
- or 1 signal contact
- or 2 auxiliary contact switches
- or 1 auxiliary switch and 1 signal contact

Contact description signal contact

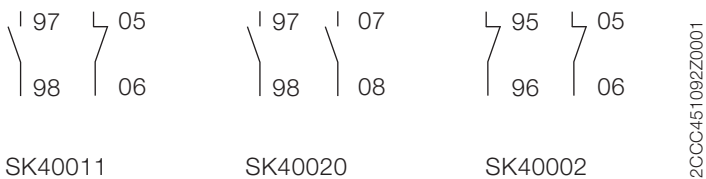

Contact description auxiliary switch

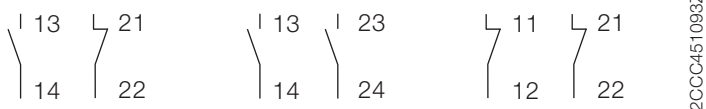

① If you use an auxiliary switch and a signal contact you must connect first the signal contact on the MS325

Auxiliary switches and signal contacts

Wiring variants

1. Wiring without auxiliary busbars LA, LB

Wiring of auxiliary switch and signal contact blocks without contact to the auxiliary busbars LA and LB.

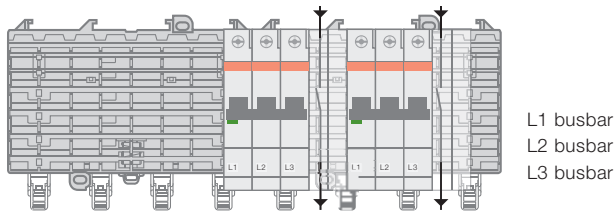

2. Input contacts the auxiliary busbars LA, LB. Standard output wiring.

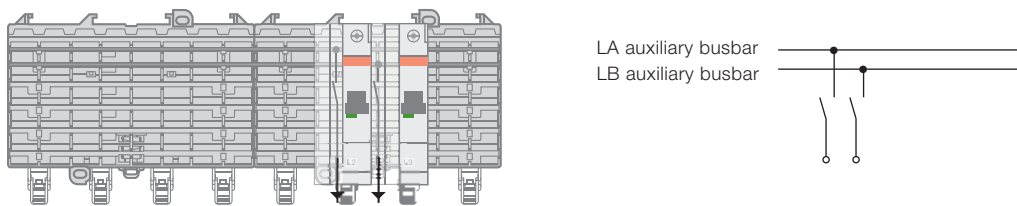

3. Collective alarm, signal contact contacts the auxiliary busbars LA, LB

A cost-effective collective alarm solution can be implemented without additional wiring by using this arrangement.

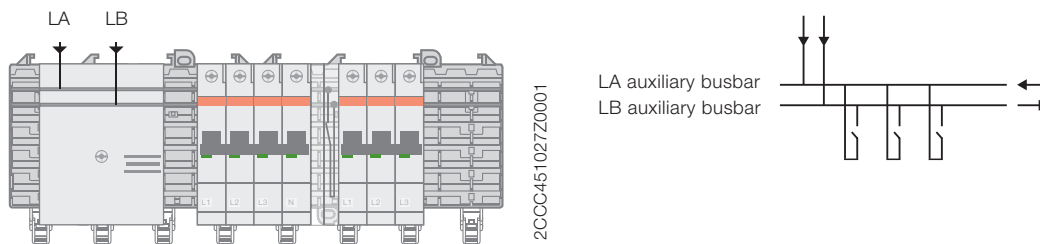

3. Collective alarm, SK40010-L and SK40010-R with S402 UC MCB

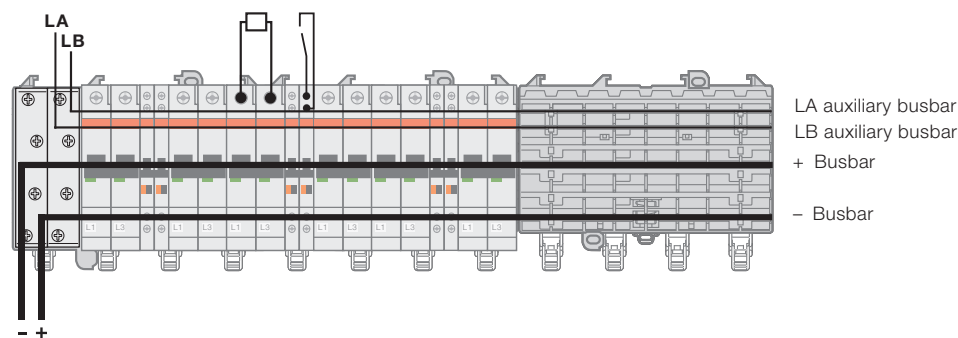

2-pole miniature circuit breakers S4020C with the signal contact collective alarm (SK400 10-L SA and SK400 10-R SA) mounted on the left and right of the miniature circuit breakers. A space-saving arrangement is possible by arranging the auxiliary and signal contacts in this way.

Auxiliary switches and signal contacts

Contact arrangements to auxiliary busbars



2CCC451136F0001

Left/right mounting of auxiliary switch/signal contact for miniature circuit breaker Space-saving on the socket system

By mounting the auxiliary switches/signal contacts alternately on the left and right, the installation width on the SMISLINE socket system can be reduced. A dummy housing is therefore not needed when just using auxiliary switches or signal contacts.

S400 miniature circuit breakers with auxiliary switches mounted on left and right:
25% space saving

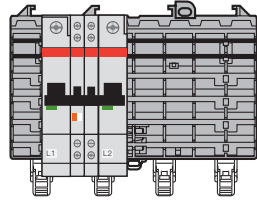

S400 miniature circuit breakers with NT40163 9 mm on the right and S400 with auxiliary switch on the left:
20% space saving

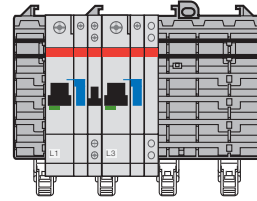

Supply options for auxiliary busbars LA and LB

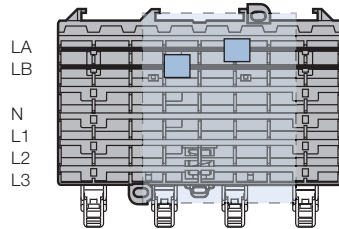

Supply option for auxiliary busbars using incoming terminal block.

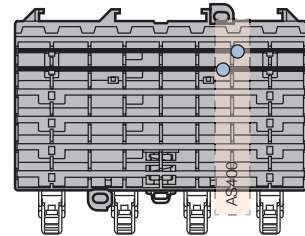

Supply option for auxiliary busbars using incoming terminal block.

Positioning of contacting piece ZLS632 on auxiliary switch and signal contact

The small auxiliary switch/signal contact contacting piece can be simply and quickly changed from the position of the LA to the LB auxiliary busbar by reversing it by 180 degree.

HK/SK 1NO, 1NC

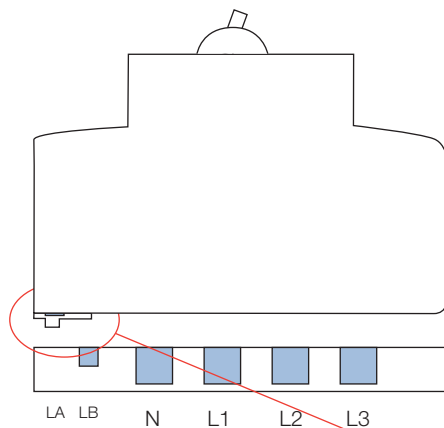

SK Collective alarm

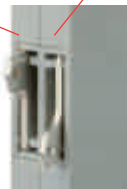
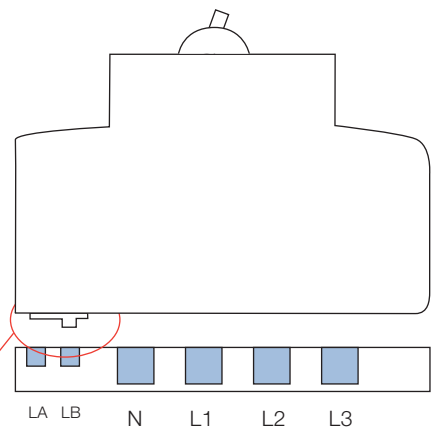

2CCC451163F0001

Shunt trip for S400, motor operating device for F404



2CCC451422F0001

Shunt trips

Function: remote opening of the device when a voltage is applied suitable for MCB S400.

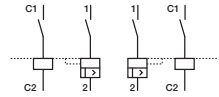

2CCC451127Z0001

Shunt trip			S2C-A1 U						S2C-A2 U				
Rated voltage	AC	V	12 ... 60						110 ... 415				
	DC	V	12 ... 60						110 ... 250				
Max. release duration		ms	< 10						< 10				
Min. release voltage	AC	V	7						55				
	DC	V	10						80				
Consumption on release	Ub	V	12 DC	12 AC	24 DC	24 AC	60 DC	60 AC	110 DC	110 AC	220 DC	230 AC	415 AC
	Ib max	A	2.2	2.5	4.5	5	14	8.8	0.35	0.5	1.1	1.0	2.7
Coil resistance		Ω	3.7						225				
Terminals		mm ²	16						16				
Tightening torque		Nm	2						2				
Dimensions (HxDxW)		mm	100x69x17.5						100x69x17.5				

S4C-CM motor operating devices

Specific features

- On the front of the device there is a moveable element for allowing or locking out remote commands. This element may be used when performing maintenance with the residual current circuit breaker in the OFF position, in order to avoid remote-activated closing operations.
- The operation can be performed via an impulse command. Manual operation is performed by moving the motorized command lever which, in the absence of an operation, allows the circuit breaker lever to be freely moved.
- The lower section of the device contains an integrated 1NO+1NC auxiliary change-over contact, which indicates the position of the contacts of the associated circuit breaker.
- The red LED on the front of the device gives a local visual indication of the intervention of the associated device.



F4C-CM motor operating devices

Technical specifications

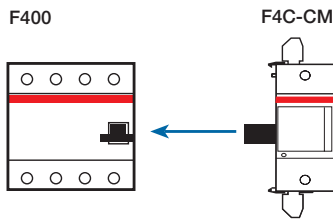

Supply voltage:	12 ... 30 VAC + 10% – 15% (50 – 60 Hz); 12 ... 48 VDC + 10% – 15%
Insulation voltage:	2500 V for 1 minute
Power consumption:	
12 VAC	< 15 VA
24 VAC	< 22 VA
30 VAC	< 25 VA
12 ... 48 VDC	< 20 VA
Power consumption at rest:	≤ 1,5 VA
Remote command*:	via free voltage contacts
Closing time at ambient temperature:	≤ 1 second
Opening time at ambient temperature:	≤ 0,5 seconds
Delay time for remote resetting after opening due to fault:	8 seconds
Number of operations:	≤ 20 000
Operating temperature:	- 25 °C ... + 55 °C
Storage temperature:	- 40 °C ... + 70 °C
Fixing:	on EN 60715 rails (35 mm) with rapid fixing system
Protection degree (EN 60529):	terminals: IP2X housing: IP4X
Cables length of control circuit:	≤ 1500 m
Cable cross-section:	≤ 2,5 mm ²
Auxiliary contact (terminals 6, 7, 8):	1NO + +NC change-over
Rated current:	3 A (250 VAC), resistive load
Command terminals:	terminal 9 = closing contact terminal 10 = opening contact terminal 11 = common reference for control contacts + 5VDC (supplied by motor operating device)

* 1) After powering up the device, wait 5 seconds before activating the command functions.

2) After opening due to a fault, wait 8 seconds before performing the remote resetting.

Wiring diagrams for F4C-ARI motor operating devices

Use at 230 V AC via a TM15/12 bell transformer

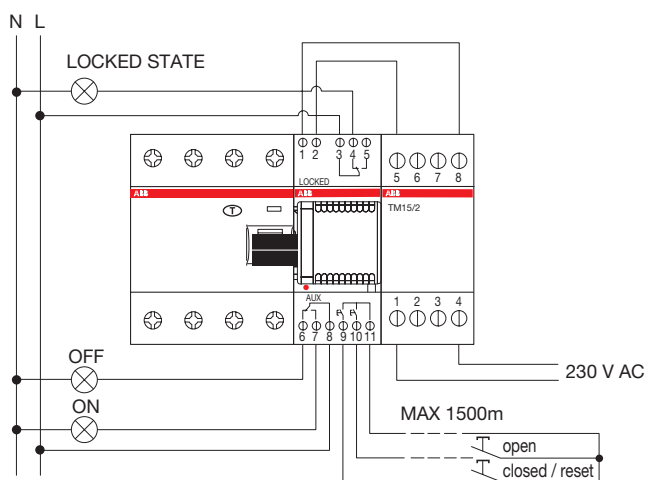

Low voltage use: 12 ... 30 V AC, 12 ... 48 V DC

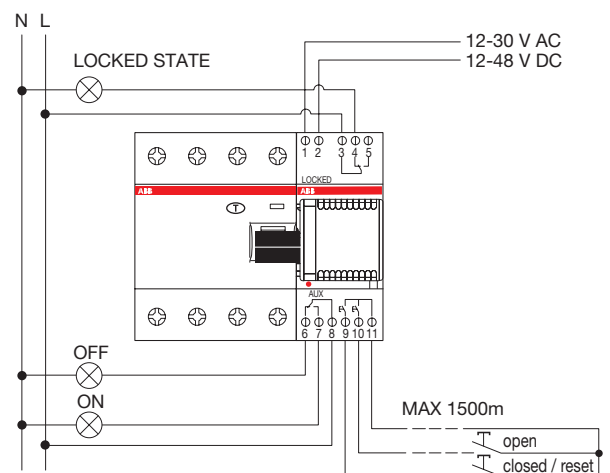

F4C-ARI auto-reclosing unit

Specific features

The F4C-ARI auto-reclosing device, installed to the right side of the residual current circuit breakers, automatically performs three reclosing attempts in the event of a fault. If the result of the three reclosing attempts is negative, the device enters a locked state.

The luminous two- colors red/green LED shows the operating state of the auto-reclosing device.

- Blinking green LED: this is displayed for five seconds after the device is powered up. When the LED stops blinking, the device is ready to operate.
- Steady green LED: the remote control is activated and the device is powered.
- LED is off: no power supply.
- Blinking red LED: reclosing cycle in progress.
- Steady red LED: the remote control is excluded on the device or is in a locked state following three unsuccessful reclosing attempts, or as a result of a remote opening command.

The lower section of the device contains an integrated 1NO+1NC auxiliary change-over contact, which indicates the position of the contacts of the associated circuit breaker.

The locked state can be reset:

- locally, by manually moving the mobile element on the front of the device to the OFF position and subsequently to the ON position. The device will reset and automatically reclose the circuit breaker;
- remotely, by means of a close command (NO contact) which resets the device and close the circuit breaker.

Using both of the resetting methods, the cycle of three reclosing attempts can be repeated.

The associated residual current circuit breaker can be remotely opened via a command with the NO contact. The remote open command locks out the resetting logic and brings the auto-reclosing device into a locked state.

Operation of the close/reset and open commands can be performed via an impulse command.

Remote commands and reclosing logic may be deactivated locally by means of the mobile element on the front of the device. This is desirable during maintenance interventions with the device in the OFF position, in order to avoid remote-activated closing operations or automatic reclosing. In this case, with the selector and the circuit breaker in the OFF position, the device may be physically locked by threading a padlock through the with draw able element on the front.



F4C-ARI motor operating devices

Technical specifications

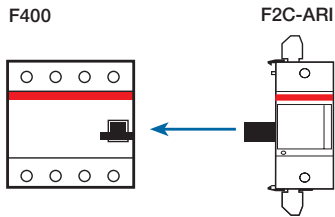

Supply voltage:	12 ... 30 VAC + 10% – 15% (50 – 60 Hz); 12 ... 48 VDC + 10% – 15%
Number of automatic reclosing attempts:	3
Counter reset time:	16 seconds
Insulation voltage:	2500V for 1 minute
Power consumption:	
12 VAC	< 15 VA
24 VAC	< 22 VA
30 VAC	< 25 VA
12 ... 48 VDC	< 20 VA
Power consumption at rest:	≤ 1,5 VA
Delay time for activation of automatic reclosing:	3 seconds
Reclosing time at ambient temperature:	≤ 1 second
Opening time at ambient temperature:	≤ 0,5 seconds
Number of operations:	≤ 20000
Operating temperature:	– 25 °C ... + 55 °C
Storage temperature:	– 40 °C ... + 70 °C
Fixing on EN 60715 rails (35 mm) with rapid fixing system	
Protection degree (EN 60529):	terminals: IP2X housing: P4X
Cables length of control circuit:	≤ 1500 m
Cable cross-section:	≤ 2,5 mm ²
Auxiliary contact (terminals 8, 9, 10):	1 change-over
Rated current:	3 A (250 VAC), resistive load
Remote command*:	via dry contacts
Command terminals:	terminal 9 = contact for closing and for remote reset of locked state terminal 10 = opening contact terminal 11 = common reference for control contacts, + 5 VDC (supplied by motor operating device)

* After powering up the device, wait 5 seconds before activating the command functions.

Wiring diagrams for F4C-ARI motor operating devices

Low voltage use of several motor operating devices:
12 ... 30 VAC, 12 ... 48 VDC

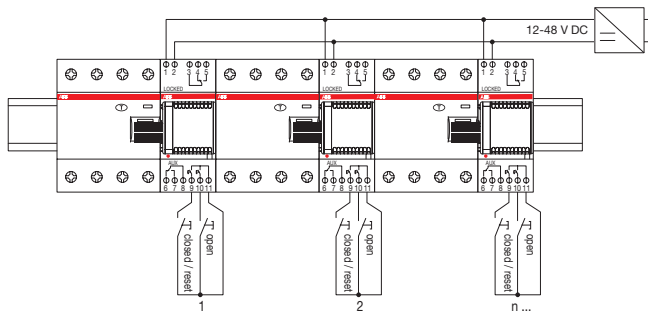

Use of several motor operating devices at 230 V AC
via a single safety transformer

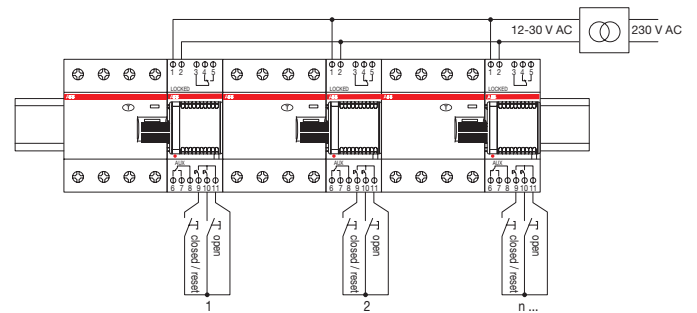

Table of contents

Dimensions of SMISLINE

3/2-4

SMISLINE dimensions (in mm)

1-, 2-, 3- and 4-pole miniature circuit breakers S400

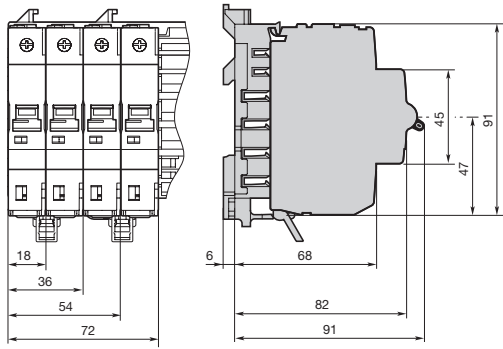

2CCC451001Z0002

Neutral disconnector

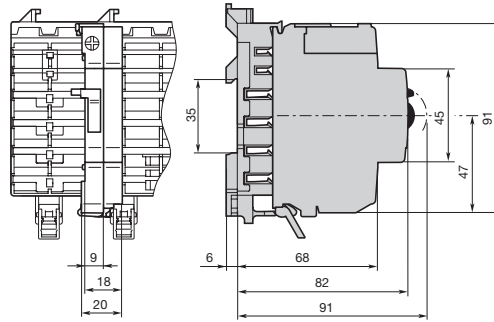

2CCC451001Z0002

4-pole residual current operated circuit breaker, switch disconnector and surge arrester

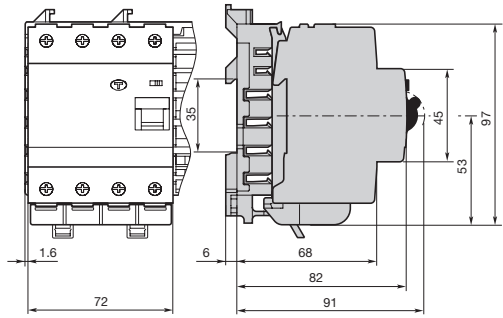

2CCC451005Z0001

2-pole residual current operated circuit breaker

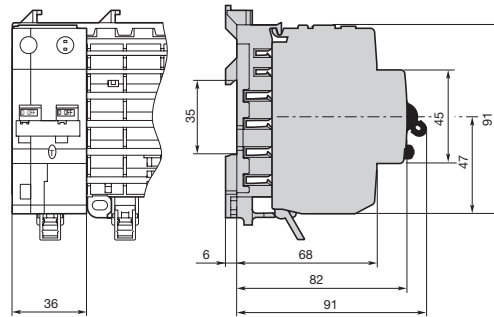

2CCC451005Z0001

Auxiliary switch and signal contact

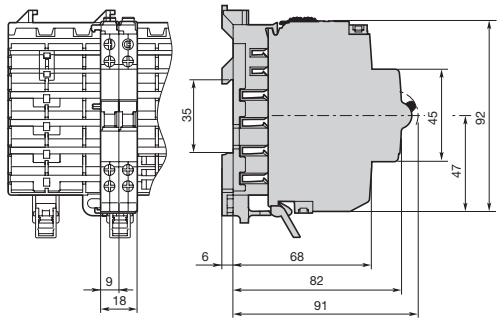

2CCC451003Z0001

4-pole residual current operated circuit breaker

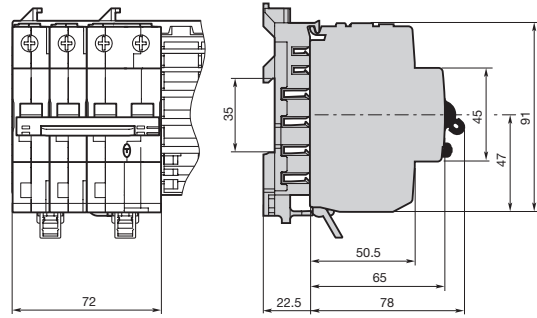

2CCC451094Z0001

High performance manual motor starter MS325

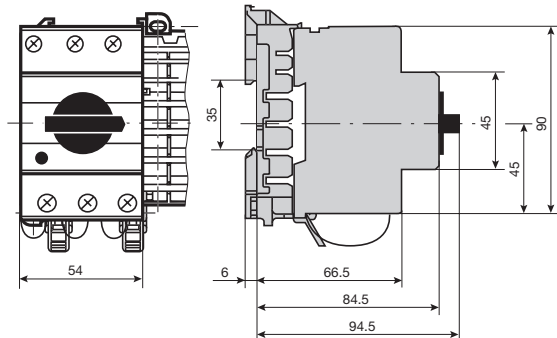

2CCC451003Z0001

F4C-CM and F4C-ARI

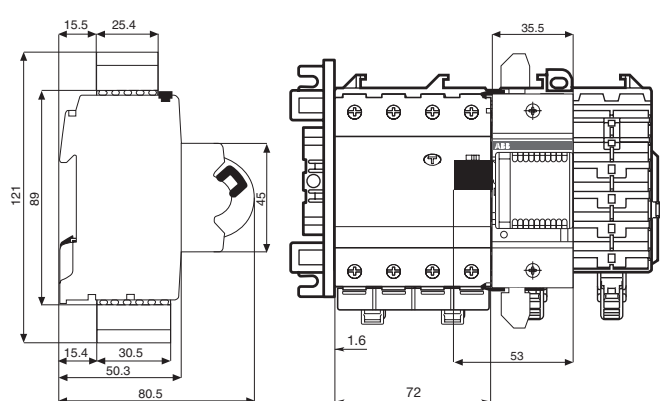

2CCC451103Z0001

SMISLINE dimensions (in mm)

Incoming terminal blocks 100 A/160 A

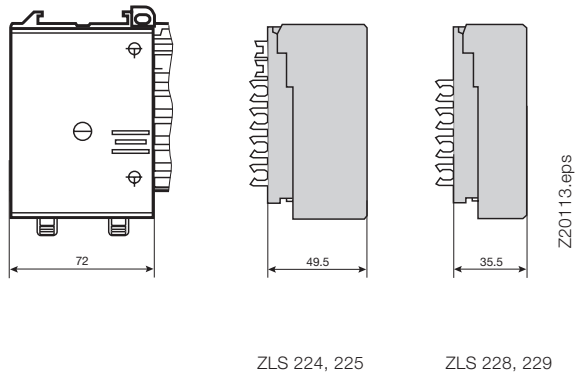

Incoming terminal component 200 A

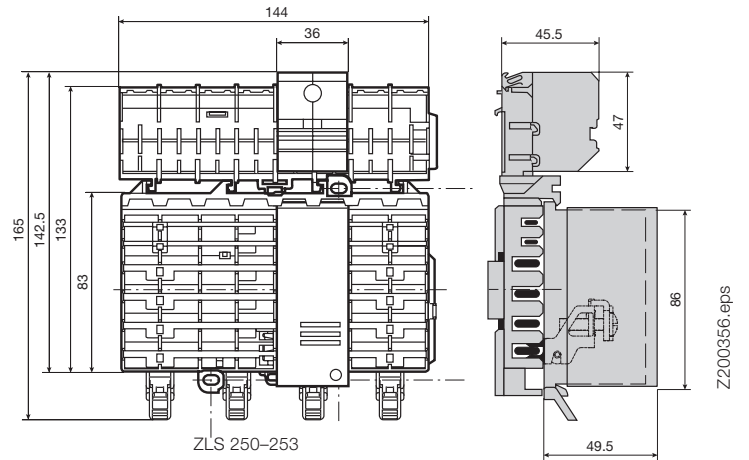

Incoming terminal blocks 63 A Incoming terminal block LA, LB

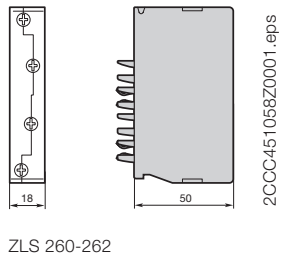

Universal adapter 32 A, 63 A

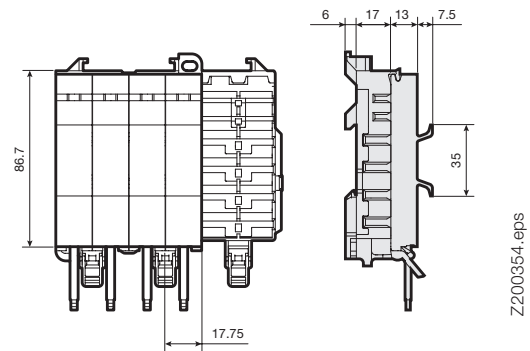

Socket base ZLS808

Receptacle
– 8 dimensional units

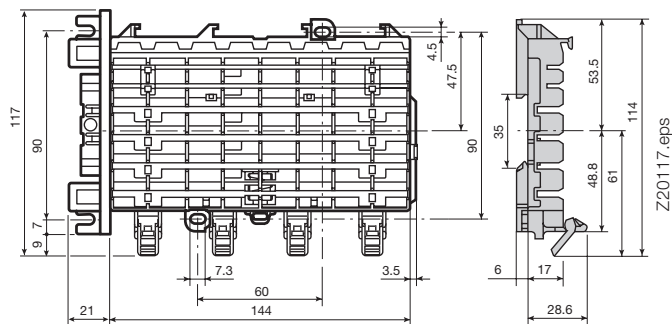

ZLS 808 with ZLS 730

Socket base ZLS806

Receptacle
– 6 dimensional units

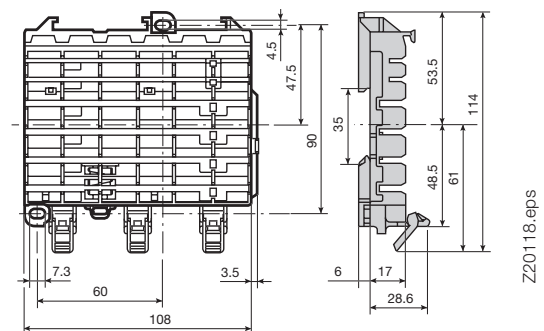

ZLS 806

SMISSLINE dimensions (in mm)

Additional socket with N and PE terminals

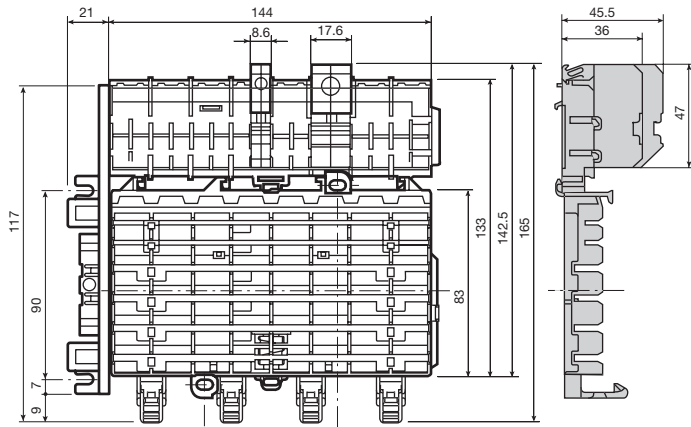

Z20119.eps

ZLS 808 mit ZLS811 und ZLS730

Intermediate piece ZLS 725

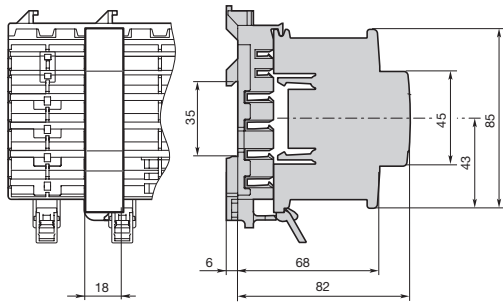

ZCCC451006Z0001

Combi module ZLS 840, 842

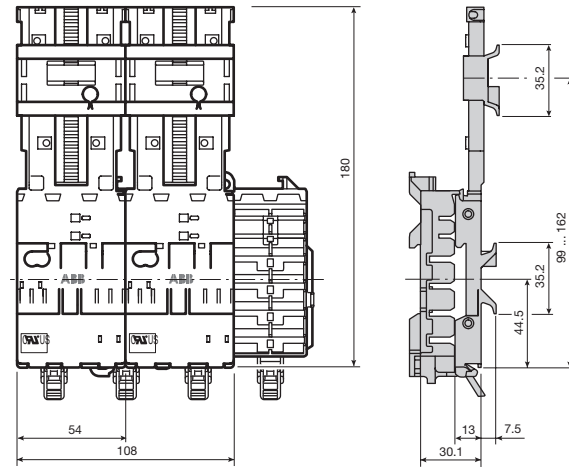

Z200465.eps

Busbar cover ZLS100

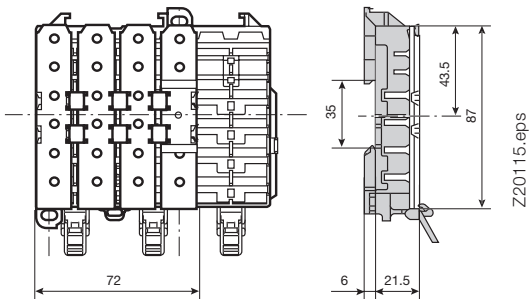

Z20115.eps

Extension adapter ZLS101

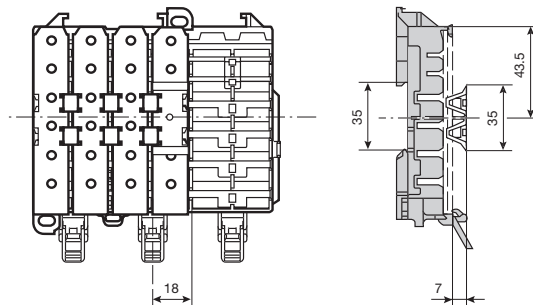



















Table of contents

Approvals and standards

4/2

Approvals and standards

According to IEC/EN

	CH	DE	US Canada			China	RU											
																		
	SEV	VDE	UL508	UL489	DNV	GL	CCC	PG	GOST	EN60947-2	EN60947-3	EN60947-5-1	EN60947-5-2	EN60947-5-3	EN60947-5-4-1	EN60947-5-4-2	EN60947-5-4-3	
Miniature circuit breaker 6 kA B S400 E	■	■									■							
Miniature circuit breaker 6 kA C S400 E	■	■									■							
Miniature circuit breaker 10 kA B S400 M	■	■			■	■		■	■		■	■						
Miniature circuit breaker 10 kA C S400 M	■	■			■	■	■	■	■	■	■	■						
Miniature circuit breaker 10 kA D S400 M	■	■			■	■		■	■		■	■						
Miniature circuit breaker 10 kA K S400 M	■				■	■	■	■	■	■	■	■						
Miniature circuit breaker 10 kA S400 UC C, Z										■								
2-pole residual current operated circuit breaker F402 (without 100 mA)	■	■						■	■			■						
2-pole short time delayed residual current operated circuit breaker F402 K	■	■						■	■			■						
RCBO FS401	■	■						■	■			■						
RCBO FS401 K	■	■						■	■			■						
RCBO FS403	□											■						
4-pole residual current operated circuit breaker F404	■	■							■			■						
4-pole short time delayed residual current operated circuit breaker F404 K	■	■							■			■						
4-pole selective residual current operated circuit breaker F404 S	■	■							■			■						
4-pole residual current operated circuit breaker, special design 16 ² / ₃ Hz F404 LF												■						
High performance manual motor starter MS325			■	■				■	■	■								■
Switch disconnecter IS404	■								■					■				
Surge arrester OVR404									■				■					
Auxiliary switch and signal contacts (1NO, 1NC)	■					■	■	■	■									■
Auxiliary switch and signal contacts (2NO, 2NC)	■																	■
Auxiliary switch and signal contacts																		■
Socket bases ZLS806/ZLS808	■		■	■	■	■	■									■	■	
Bus Bar ZLS200	■		■	■	■	■	■									■	■	
Socket End Piece	■		■	■	■	■	■									■	■	
Bus Bar Cover ZLS100, 101, 239	■		■	■	■	■	■									■	■	
Incoming terminal blocks ZLS224/ZLS225	■		■	■	■	■	■									■	■	
Incoming terminal component ZLS254, 255	■					■	■									■	■	
Incoming terminal component ZLS250-253	■		■	■	■													
Universal adapter 25 A, 45 A	■		■	■	■	■	■									■	■	
Universal adapter 32 A, 63 A	■			■	■	■	■									■	■	
Universal adapter 100 A ZLS240, 241	■				■	■	■									■	■	
Terminals for additional socket ZLS812, ZLS815	■					■	■									■	■	
Terminals for additional socket ZLS813, ZLS816	■					■	■									■	■	
Combi module			■	■														

■ Approved
□ Device is submitted for approval

Contact us

Belgium

ABB ELECTRO n.v.
Hoge Wei, 27
1930 Zaventem
Belgium
Telephone +32 (0) 27 18 63 11
Telefax +32 (0) 27 18 66 66

www.abb.be

Brasil

ABB Ltda
Av. dos Autonomistas, 1496
06020-902-Osasco-SP
Brasil
Telephone +55 (0) 80 00 14 91 11
Telefax +55 (11) 36 88 99 77

www.abb.com.br

Czech Republic

ABB s.r.o.
Herspická 13
61900 Brno
Czech Republic
Telephone +420 54 31 45 50 3
Telefax +420 54 32 43 48 9

www.abb.cz/elsynn

Denmark

ABB AS
Meterbuen 33
2740 Skovlunde
Denmark
Telephone +45 44 50 44 50
Telefax +45 44 50 44 60

www.abb.dk

Finland

ABB OY
Domestic Sales
Hiomotie 13
P.O. Box 184
00381 Helsinki
Finland
Telephone +358 10 22 20 00
Telefax +358 10 22 22 91 3

www.abb.fi

France

ABB Entrelec
Division Commercial France
300 rue des Prés Seigneurs
ZA La Boisse – BP 90145
01124 Montluel Cedex
France
Telephone +33 (0) 825 38 63 55
Telefax +33 (0) 825 87 09 26

www.abb.fr

ABB Switzerland Ltd.

CMC Low Voltage Products
Fulachstrasse 150
CH-8201 Schaffhausen
Telefon +41 (0) 58 586 41 11
Telefax +41 (0) 58 586 42 22

www.abb.ch

Great Britain

ABB Limited
Tower Court
Foleshill Enterprise Park
Courtaulds Way
Conventry
CV6 5NX
England
Telephone +44 (0) 24 76 36 85 00
Telefax +44 (0) 24 76 36 44 99

www.abb.co.uk

Ireland

Asea Brown Boveri Ltd.
Belgrad Road, Tallaght
Dublin 24
Ireland
Telephone +35 31 40 57 30 0
Telefax +35 31 40 57 33 2

www.abb.com/lowvoltage

Italy

ABB SACE S.p.A.
Line Protection Devices
Viale dell'Industria, 18
20010 Vittuone (MI)
Italy
Telephone +39 02 90 34 1
Telefax: +39 02 90 34 76 09

www.abb.it

Netherland

ABB b.v.
Automation Products
George Hintzenweg 81
3068 AV Rotterdam
Postbus 301
3000 AH Rotterdam
Netherland
Telephone +31 (0) 10 40 78 91 1
Telefax +31 (0) 10 40 78 09 0

www.abb.nl

Norway

ABB AS
Jacob Borchsgt. 6
P.O. Box 797 Brakeroya
3002 Drammen
Norway
Telephone +47 32 24 80 00
Telefax +47 32 24 79 34

www.abb.no

Poland

ABB Sp. z o. o.
Automation Products
ul. Zeganska 1
04-713 Warszawa
Poland
Telephone +48 22 51 64 441
Telefax +48 22 51 64 444

www.abb.pl

P.R. China

ABB (China) Ltd
Universal Plaza, 10 Jiuxianqiao Lu
Chaoyang District
100016 Beijing
P.R. China
Telephone +86 10 8456 6688
Telefax +86 10 8456 9907

www.abb.com.cn

Russian Federation

ABB Industrial & Building Systems Ltd.
30/1, bld. 2 Obrucheva St.
117861 Moscow, Russia
Telephone +7 495 960 2200
Telefax +7 495 960 2220

www.abb.ru/ibs

Singapur

ABB Pte Ltd
2 Ayer Rajah Crescent
Singapore 139935
Main Tel +65 6776 5711
Main Fax +65 6778 0222

www.abb.com.sg

Spain

ABB Automation Products, S.A.
c/Torrent d'Olla, 220
08012 Barcelona
Spain
Telephone +34 93 48 42 10 4
Telefax +34 93 48 42 20 1

www.abb.es

Sweden

ABB Automation
Technologies Cewe Control
Motörgråd 20
72161 Västerås
Sweden
Telephone +46 (0) 21 32 07 00
Telefax +46 (0) 21 12 60 01

www.abb.se

Thailand

ABB LIMITED
161/1 SG Tower, 1st-4th Floor,
Soi Mahadlekluang 3,
Rajdamri Road, Lumpini, Pathumwan,
Bangkok 10330

Thailand
Telephone +66 (0) 2665 1000
Telefax +66 (0) 2665 1043

www.abb.co.th

Ukraine

ABB Ltd, Ukraine
Automation Products Low Voltage
4, Ivana Lepsa Blvd.
Kiev 67, 03680
Ukraine
Telephone +380 44 495 22 11
Telefax +380 44 495 22 10

www.abb.ua

In consideration of modification to standards and materials, the characteristics and overall dimensions indicated in this catalogue may be binding only following confirmation by ABB.

Power and productivity
for a better world™

