

Control Stations \varnothing 22

► CONTROL STATIONS - NON-ILLUMINATED

 Technical Info (p. 103)

MUSHROOM HEAD \varnothing 40 EN 418 / ISO 13850



Push-pull to reset

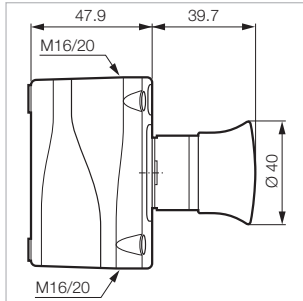

LBX15101



Compliant with the requirements of emergency stop:
EN 418 / ISO 13850

● Red	NC		EMERGENCY STOP	LBX15301
● Red	NC + NO		EMERGENCY STOP	LBX15311
● Red	2 NC		EMERGENCY STOP	LBX15302

For contact blocks attached to operator please contact us.

MUSHROOM HEAD \varnothing 40 EN 418 / ISO 13850

Key to reset



Part Number

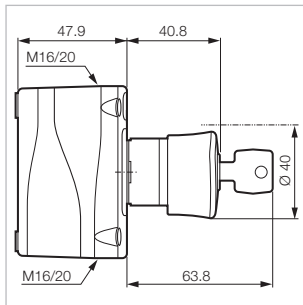

LBX11302



Compliant with the requirements of emergency stop:
EN 418 / ISO 13850
Supplied with 2 keys profile n° 455

● Red	NC		EMERGENCY STOP	LBX11301
● Red	NC + NO		EMERGENCY STOP	LBX11311
● Red	2 NC		EMERGENCY STOP	LBX11302

For contact blocks attached to operator please contact us.

MUSHROOM HEAD \varnothing 54 EN 418 / ISO 13850

Push-pull to reset with flag indicator





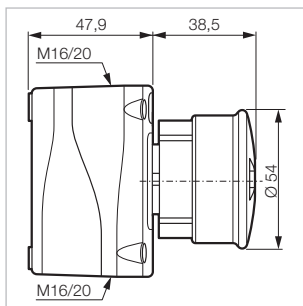

Part Number









LBX14201



Compliant with the requirements of emergency stop:
EN 418 / ISO 13850
Double position indicator: head and collar

● Red	NC			LBX14101
● Red	NC + NO			LBX14111
● Red	2 NC			LBX14102

● Red	NC		STOP - 	LBX14201
● Red	NC + NO		STOP - 	LBX14211
● Red	2 NC		STOP - 	LBX14202

For contact blocks attached to operator please contact us.