



WSE12-3P1131

W12-3

SMALL PHOTOELECTRIC SENSORS

SICK
Sensor Intelligence.



Illustration may differ

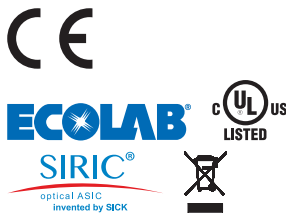

Ordering information

Type	Part no.
WSE12-3P1131	1041460

Included in delivery: BEF-KH-W12 (2)

Other models and accessories → www.sick.com/W12-3

Detailed technical data

Features

Sensor/ detection principle	Through-beam photoelectric sensor
Dimensions (W x H x D)	15.6 mm x 48.5 mm x 42 mm
Housing design (light emission)	Rectangular
Sensing range max.	0 m ... 20 m
Sensing range	0 m ... 15 m
Type of light	Visible red light
Light source	LED ¹⁾
Light spot size (distance)	Ø 220 mm (15 m)
Angle of dispersion	Approx. 1.5°
Wave length	640 nm
Adjustment	Potentiometer, 5 turns

¹⁾ Average service life: 100,000 h at T_J = +25 °C.

Mechanics/electronics

Supply voltage	10 V DC ... 30 V DC ¹⁾
-----------------------	-----------------------------------

- ¹⁾ Limit values when operated in short-circuit protected network: max. 8 A.
- ²⁾ May not exceed or fall below U_V tolerances.
- ³⁾ Without load.
- ⁴⁾ Signal transit time with resistive load.
- ⁵⁾ With light/dark ratio 1:1.
- ⁶⁾ Do not bend below 0 °C.
- ⁷⁾ A = V_S connections reverse-polarity protected.
- ⁸⁾ C = interference suppression.
- ⁹⁾ D = outputs overcurrent and short-circuit protected.

Ripple	$\leq 5 V_{pp}$ ²⁾
Power consumption, sender	$\leq 30 \text{ mA}$ ³⁾
Power consumption, receiver	$\leq 15 \text{ mA}$ ³⁾
Switching output	PNP
Output function	Complementary
Switching mode	Light/dark switching
Signal voltage PNP HIGH/LOW	$> U_v - 2,5 \text{ V} / \text{ca. } 0 \text{ V}$
Output current I_{max}	100 mA
Response time	$\leq 330 \mu\text{s}$ ⁴⁾
Switching frequency	1,500 Hz ⁵⁾
Connection type	Cable, 4-wire, 2 m ⁶⁾
Cable material	PVC
Conductor cross-section	0.25 mm ²
Circuit protection	A ⁷⁾ C ⁸⁾ D ⁹⁾
Protection class	III
Weight	200 g
Housing material	Metal
Optics material	Plastic, PMMA
Enclosure rating	IP66 IP67 IP69K
Items supplied	2 x clamps BEF-KH-W12, incl. screws
Test input sender off	TE to 0 V
Ambient operating temperature	-40 °C ... +60 °C
Ambient storage temperature	-40 °C ... +75 °C
UL File No.	NRKH.E181493 & NRKH7.E181493
Part number of individual components	2044880 WSE12-3 2045601 WS12-3D1130

¹⁾ Limit values when operated in short-circuit protected network: max. 8 A.

²⁾ May not exceed or fall below U_v tolerances.

³⁾ Without load.

⁴⁾ Signal transit time with resistive load.

⁵⁾ With light/dark ratio 1:1.

⁶⁾ Do not bend below 0 °C.

⁷⁾ A = V_S connections reverse-polarity protected.

⁸⁾ C = interference suppression.

⁹⁾ D = outputs overcurrent and short-circuit protected.

Safety-related parameters

MTTF_D	826 years
DC_{avg}	0%

Classifications

ECI@ss 5.0	27270901
-------------------	----------

ECl@ss 5.1.4	27270901
ECl@ss 6.0	27270901
ECl@ss 6.2	27270901
ECl@ss 7.0	27270901
ECl@ss 8.0	27270901
ECl@ss 8.1	27270901
ECl@ss 9.0	27270901
ECl@ss 10.0	27270901
ECl@ss 11.0	27270901
ETIM 5.0	EC002716
ETIM 6.0	EC002716
ETIM 7.0	EC002716
UNSPSC 16.0901	39121528

Connection diagram

Cd-088

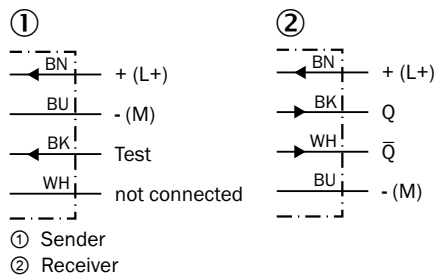

Characteristic curve

WSE12-3

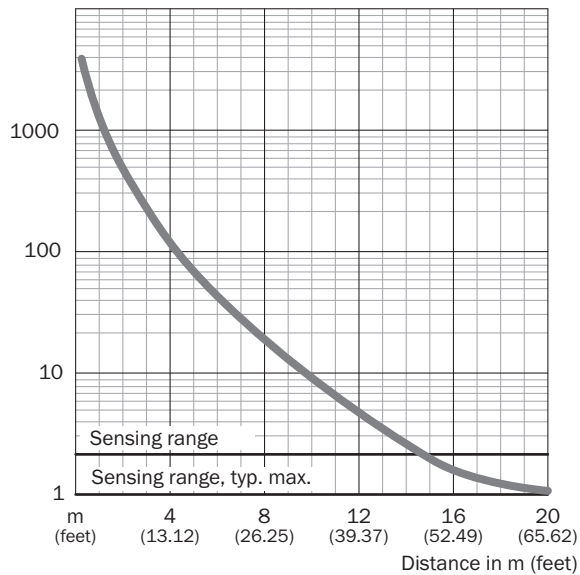

Sensing range diagram

WSE12-3

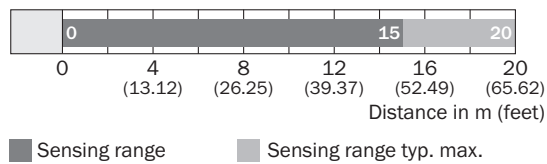

Adjustments possible

WL12-3, WSE12-3

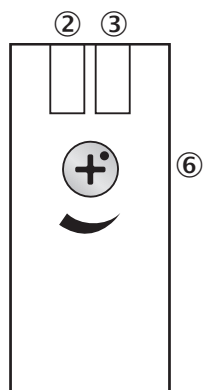

- ② LED indicator yellow: Status of received light beam
- ③ LED indicator green: Supply voltage active
- ⑥ Sensitivity control: potentiometer

Dimensional drawing (Dimensions in mm (inch))

WL12-3, WSE12-3

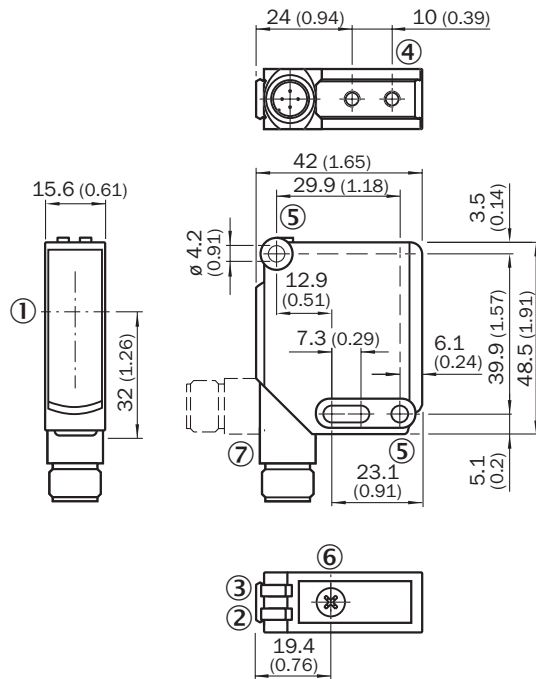

- ① Optical axis
- ② LED indicator yellow: Status of received light beam
- ③ LED indicator green: Supply voltage active
- ④ M4 threaded mounting hole, 4 mm deep
- ⑤ Mounting hole, \varnothing 4.2 mm
- ⑥ Sensitivity control: potentiometer
- ⑦ Connection

Recommended accessories

Other models and accessories → www.sick.com/W12-3

	Brief description	Type	Part no.
Plug connectors and cables			
	Head A: male connector, M12, 4-pin, straight Head B: - Cable: unshielded	STE-1204-G	6009932

SICK AT A GLANCE

SICK is one of the leading manufacturers of intelligent sensors and sensor solutions for industrial applications. A unique range of products and services creates the perfect basis for controlling processes securely and efficiently, protecting individuals from accidents and preventing damage to the environment.

We have extensive experience in a wide range of industries and understand their processes and requirements. With intelligent sensors, we can deliver exactly what our customers need. In application centers in Europe, Asia and North America, system solutions are tested and optimized in accordance with customer specifications. All this makes us a reliable supplier and development partner.

Comprehensive services complete our offering: SICK LifeTime Services provide support throughout the machine life cycle and ensure safety and productivity.

For us, that is “Sensor Intelligence.”

WORLDWIDE PRESENCE:

Contacts and other locations –www.sick.com