



# GTE6-P7211

G6

MINIATURE PHOTOELECTRIC SENSORS

**SICK**  
Sensor Intelligence.



Illustration may differ



### Ordering information

| Type       | Part no. |
|------------|----------|
| GTE6-P7211 | 1053589  |

Other models and accessories → [www.sick.com/G6](http://www.sick.com/G6)

### Detailed technical data

#### Features

|  |   |
|--|---|
| <b>Sensor/ detection principle</b>     | Photoelectric proximity sensor, Energetic |
| <b>Dimensions (W x H x D)</b>          | 12 mm x 31.5 mm x 21 mm                   |
| <b>Housing design (light emission)</b> | Rectangular                               |
| <b>Sensing range max.</b>              | ≤ 300 mm <sup>1)</sup>                    |
| <b>Sensing range</b>                   | ≤ 250 mm                                  |
| <b>Type of light</b>                   | Visible red light                         |
| <b>Light source</b>                    | PinPoint LED <sup>2)</sup>                |
| <b>Light spot size (distance)</b>      | Ø 7 mm (90 mm)                            |
| <b>Wave length</b>                     | 650 nm                                    |
| <b>Adjustment</b>                      | Mechanical spindle, 5 turns               |

<sup>1)</sup> Object with 90 % reflectance (referred to standard white, DIN 5033).

<sup>2)</sup> Average service life: 100,000 h at T<sub>J</sub> = +25 °C.

#### Mechanics/electronics

|                       |                                   |
|-----------------------|-----------------------------------|
| <b>Supply voltage</b> | 10 V DC ... 30 V DC <sup>1)</sup> |
| <b>Ripple</b>         | ± 10 % <sup>2)</sup>              |

<sup>1)</sup> Limit values when operated in short-circuit protected network: max. 8 A.

<sup>2)</sup> May not exceed or fall below U<sub>v</sub> tolerances.

<sup>3)</sup> Without load.

<sup>4)</sup> At U<sub>v</sub> > 24 V, I<sub>A</sub> max. = 50 mA.

<sup>5)</sup> Signal transit time with resistive load.

<sup>6)</sup> With light/dark ratio 1:1.

<sup>7)</sup> Do not bend below 0 °C.

<sup>8)</sup> A = V<sub>S</sub> connections reverse-polarity protected.

<sup>9)</sup> B = inputs and output reverse-polarity protected.

<sup>10)</sup> D = outputs overcurrent and short-circuit protected.

<sup>11)</sup> Temperature stability following adjustment +/-10 °C.

|   |  |
|---|--|
| <b>Current consumption</b>                        | 30 mA <sup>3)</sup>  |
| <b>Switching output</b>                           | PNP  |
| <b>Switching mode</b>                             | Light/dark switching   |
| <b>Switching mode selector</b>                    | Selectable via light/dark selector   |
| <b>Signal voltage PNP HIGH/LOW</b>                | $V_S - (\leq 3 \text{ V}) / \text{ approx. } 0 \text{ V}$                    |
| <b>Output current <math>I_{\text{max}}</math></b> | $\leq 100 \text{ mA}$ <sup>4)</sup>  |
| <b>Response time</b>                              | $< 1,250 \text{ ms}$ <sup>5)</sup>   |
| <b>Switching frequency</b>                        | 500 Hz <sup>6)</sup>   |
| <b>Connection type</b>                            | Cable with M12 male connector, 4-pin, 300 mm <sup>7)</sup>                   |
| <b>Cable material</b>                             | PVC  |
| <b>Circuit protection</b>                         | A <sup>8)</sup><br>B <sup>9)</sup><br>D <sup>10)</sup>                       |
| <b>Protection class</b>                           | III  |
| <b>Weight</b>                                     | 60 g   |
| <b>Housing material</b>                           | Plastic, ABS/PC  |
| <b>Optics material</b>                            | Plastic, PMMA  |
| <b>Enclosure rating</b>                           | IP67   |
| <b>Ambient operating temperature</b>              | $-25 \text{ }^\circ\text{C} \dots +55 \text{ }^\circ\text{C}$ <sup>11)</sup> |
| <b>Ambient storage temperature</b>                | $-40 \text{ }^\circ\text{C} \dots +70 \text{ }^\circ\text{C}$                |
| <b>UL File No.</b>                                | NRKH.E348498 & NRKH7.E348498   |

<sup>1)</sup> Limit values when operated in short-circuit protected network: max. 8 A.

<sup>2)</sup> May not exceed or fall below  $U_V$  tolerances.

<sup>3)</sup> Without load.

<sup>4)</sup> At  $U_V > 24 \text{ V}$ ,  $I_A \text{ max.} = 50 \text{ mA}$ .

<sup>5)</sup> Signal transit time with resistive load.

<sup>6)</sup> With light/dark ratio 1:1.

<sup>7)</sup> Do not bend below  $0 \text{ }^\circ\text{C}$ .

<sup>8)</sup> A =  $V_S$  connections reverse-polarity protected.

<sup>9)</sup> B = inputs and output reverse-polarity protected.

<sup>10)</sup> D = outputs overcurrent and short-circuit protected.

<sup>11)</sup> Temperature stability following adjustment  $\pm 10 \text{ }^\circ\text{C}$ .

## Classifications

|                     |          |
|---------------------|----------|
| <b>ECl@ss 5.0</b>   | 27270903 |
| <b>ECl@ss 5.1.4</b> | 27270903 |
| <b>ECl@ss 6.0</b>   | 27270903 |
| <b>ECl@ss 6.2</b>   | 27270903 |
| <b>ECl@ss 7.0</b>   | 27270903 |
| <b>ECl@ss 8.0</b>   | 27270903 |
| <b>ECl@ss 8.1</b>   | 27270903 |
| <b>ECl@ss 9.0</b>   | 27270903 |
| <b>ECl@ss 10.0</b>  | 27270904 |
| <b>ECl@ss 11.0</b>  | 27270904 |

|                       |          |
|-----------------------|----------|
| <b>ETIM 5.0</b>       | EC001821 |
| <b>ETIM 6.0</b>       | EC001821 |
| <b>ETIM 7.0</b>       | EC002719 |
| <b>UNSPSC 16.0901</b> | 39121528 |

### Connection diagram

Cd-066

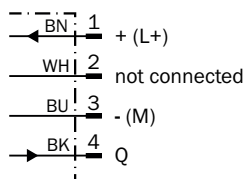

### Characteristic curve

GTE6

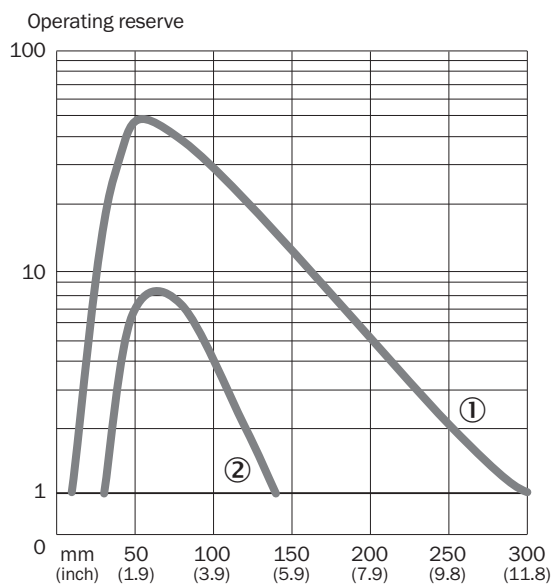

- ① Sensing range on white, 90% remission
- ② Sensing range on gray, 18 % remission

### Light spot size

GTE6

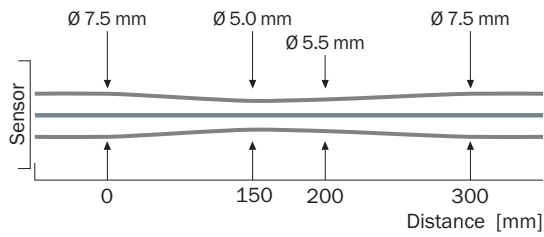

### Sensing range diagram

GTE6

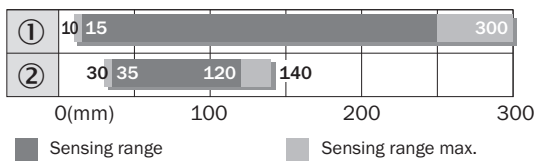

- ① Object with 90% remission (based on standard white DIN 5033)
- ② Sensing range on gray, 18% remission

### Adjustments possible

Adjustment possibility

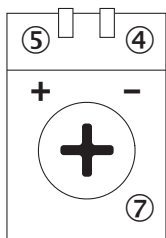

- ④ LED indicator green: Supply voltage active
- ⑤ LED indicator yellow: Status of received light beam
- ⑦ Sensitivity control: potentiometer

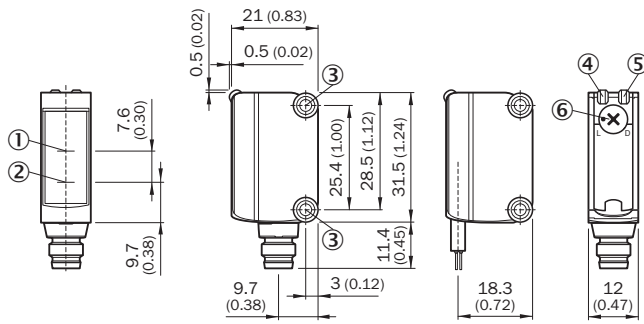

### Dimensional drawing (Dimensions in mm (inch))



- ① Optical axis, receiver
- ② Optical axis, sender
- ③ Mounting holes M3
- ④ LED indicator green: Supply voltage active
- ⑤ LED indicator yellow: Status of received light beam
- ⑥ Light/ dark rotary switch: L = light switching, D = dark switching

### Recommended accessories

Other models and accessories → [www.sick.com/G6](http://www.sick.com/G6)

|   | Brief description   | Type               | Part no. |
|---|---|--------------------|----------|
| Plug connectors and cables  |   |                    |          |
|  | Head A: female connector, M12, 4-pin, straight, A-coded<br>Head B: Flying leads<br>Cable: Sensor/actuator cable, PVC, unshielded, 5 m | YF2A14-050VB3XLEAX | 2096235  |
|  | Head A: male connector, M12, 4-pin, straight<br>Head B: -<br>Cable: unshielded  | STE-1204-G         | 6009932  |

## SICK AT A GLANCE

SICK is one of the leading manufacturers of intelligent sensors and sensor solutions for industrial applications. A unique range of products and services creates the perfect basis for controlling processes securely and efficiently, protecting individuals from accidents and preventing damage to the environment.

We have extensive experience in a wide range of industries and understand their processes and requirements. With intelligent sensors, we can deliver exactly what our customers need. In application centers in Europe, Asia and North America, system solutions are tested and optimized in accordance with customer specifications. All this makes us a reliable supplier and development partner.

Comprehensive services complete our offering: SICK LifeTime Services provide support throughout the machine life cycle and ensure safety and productivity.

For us, that is “Sensor Intelligence.”

## WORLDWIDE PRESENCE:

Contacts and other locations –[www.sick.com](http://www.sick.com)