



WTT190L-K2233

PowerProx

MULTITASK PHOTOELECTRIC SENSORS

SICK
Sensor Intelligence.



Illustration may differ



Ordering information

Type	Part no.
WTT190L-K2233	6062141

Included in delivery: BEF-W190 (1)

Other models and accessories → www.sick.com/PowerProx

Detailed technical data

Features

Sensor/ detection principle	Photoelectric proximity sensor, Background suppression
Dimensions (W x H x D)	17.4 mm x 45.6 mm x 34.7 mm
Housing design (light emission)	Rectangular
Sensing range max.	200 mm ... 3,000 mm ¹⁾
Sensing range	200 mm ... 3,000 mm ²⁾
Type of light	Visible red light
Light source	Laser ³⁾
Light spot size (distance)	Ø 12 mm (3,000 mm)
Wave length	658 nm
Laser class	1 (IEC 60825-1 / CDRH 21 CFR 1040.10 & 1040.11)
Adjustment	Single teach-in button (4 x) Display

¹⁾ Object with 6 ... 90 % remission (based on standard white to DIN 5033).

²⁾ Adjustable.

³⁾ Average service life: 100,000 h at T_J = +25 °C.

Mechanics/electronics

Supply voltage	10 V DC ... 30 V DC ¹⁾
Ripple	$\leq 5 V_{pp}$ ²⁾
Current consumption	75 mA ³⁾
Switching output	PNP ⁴⁾ NPN ⁵⁾
Number of switching outputs	2 (Q ₁ , Q ₂) ⁴⁾
Switching mode	Light/dark switching ⁴⁾
Switching mode selector	Selectable via menu
Output current I_{max}	≤ 100 mA
Response time	0.6 ms, 1 ms, 3.4 ms, 13 ms, 51.4 ms ^{6) 7) 8)}
Switching frequency	833 Hz, 500 Hz, 147 Hz, 38 Hz, 10 Hz ^{7) 8) 9)}
Time functions	Without time delay Off delay On delay One shot
Delay time	Programmable, 0 ms ... 999 ms
Analog output	-
Input	MF _{in} = multifunctional input programmable ¹⁰⁾
Connection type	Male connector M8, 4-pin
Circuit protection	A ¹¹⁾ B ¹²⁾ C ¹³⁾
Protection class	III
Weight	25 g
Housing material	Plastic, ABS
Optics material	Plastic, PMMA
Enclosure rating	IP67
Items supplied	BEF-W190 mounting bracket
Ambient operating temperature	-30 °C ... +50 °C ¹⁴⁾
Ambient storage temperature	-40 °C ... +70 °C

- ¹⁾ Limit values. Operated in short-circuit protected network: max. 8 A.
²⁾ May not exceed or fall below U_v tolerances.
³⁾ Without load. At V_S = 24 V.
⁴⁾ Q₁, Q₂ = 2 switching thresholds, light/dark switching selectable via light/dark selector.
⁵⁾ PNP/NPN switchable.
⁶⁾ Signal transit time with resistive load.
⁷⁾ Can be set via a mean value filter (AVG1, AVG4, AVG16, AVG64, AVG256).
⁸⁾ Depending on distance to object, distance to background and selected switching threshold.
⁹⁾ With light/dark ratio 1:1.
¹⁰⁾ External teach-in via cable, laser shutdown.
¹¹⁾ A = V_S connections reverse-polarity protected.
¹²⁾ B = inputs and output reverse-polarity protected.
¹³⁾ C = interference suppression.
¹⁴⁾ V_S ≥ 24 V. Below T_a < -10 °C warm-up time < 10 min.
¹⁵⁾ For best performance consider warm up time ≤ 5 minutes.

Warm-up time	< 5 min ¹⁵⁾
Initialization time	< 300 ms

- 1) Limit values. Operated in short-circuit protected network: max. 8 A.
- 2) May not exceed or fall below U_V tolerances.
- 3) Without load. At $V_S = 24$ V.
- 4) Q1, Q2 = 2 switching thresholds, light/dark switching selectable via light/dark selector.
- 5) PNP/NPN switchable.
- 6) Signal transit time with resistive load.
- 7) Can be set via a mean value filter (AVG1, AVG4, AVG16, AVG64, AVG256).
- 8) Depending on distance to object, distance to background and selected switching threshold.
- 9) With light/dark ratio 1:1.
- 10) External teach-in via cable, laser shutdown.
- 11) A = V_S connections reverse-polarity protected.
- 12) B = inputs and output reverse-polarity protected.
- 13) C = interference suppression.
- 14) $V_S \geq 24$ V. Below $T_a < -10$ °C warm-up time < 10 min.
- 15) For best performance consider warm up time ≤ 5 minutes.

Safety-related parameters

MTTF_D	174.4 years
DC_{avg}	0%

Classifications

ECl@ss 5.0	27270904
ECl@ss 5.1.4	27270904
ECl@ss 6.0	27270904
ECl@ss 6.2	27270904
ECl@ss 7.0	27270904
ECl@ss 8.0	27270904
ECl@ss 8.1	27270904
ECl@ss 9.0	27270904
ECl@ss 10.0	27270904
ECl@ss 11.0	27270904
ETIM 5.0	EC002719
ETIM 6.0	EC002719
ETIM 7.0	EC002719
UNSPSC 16.0901	39121528

Connection diagram

Cd-369

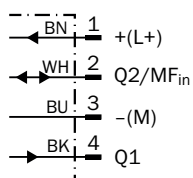

Characteristic curve

Min. distance from object to background in mm (inch)

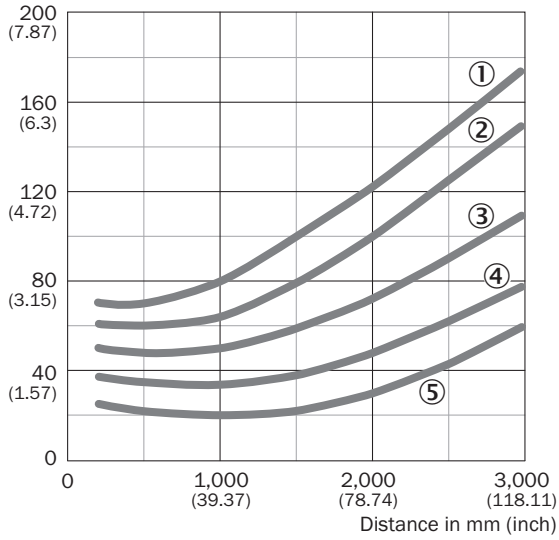

- ① 6 % / 90 % AVG1
- ② 6 % / 90 % AVG4
- ③ 6 % / 90 % AVG16
- ④ 6 % / 90 % AVG64
- ⑤ 6 % / 90 % AVG256

Min. distance from object to background in mm (inch)

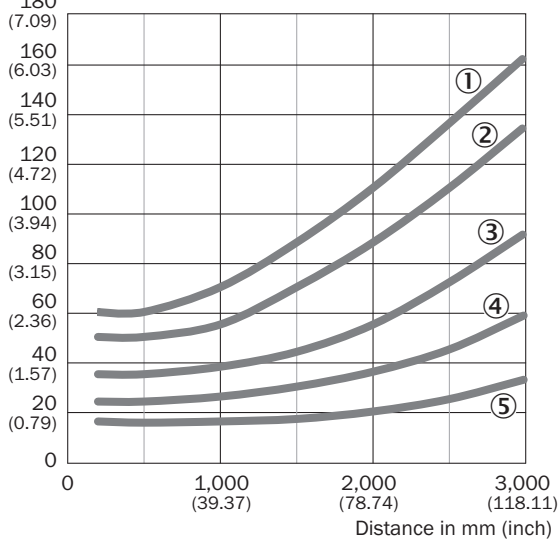

- ① 90 % / 90 % AVG1
- ② 90 % / 90 % AVG4
- ③ 90 % / 90 % AVG16
- ④ 90 % / 90 % AVG64
- ⑤ 90 % / 90 % AVG256

Light spot size

Radius mm (inch)

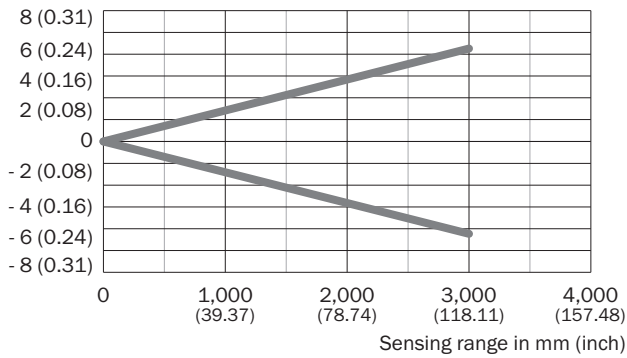

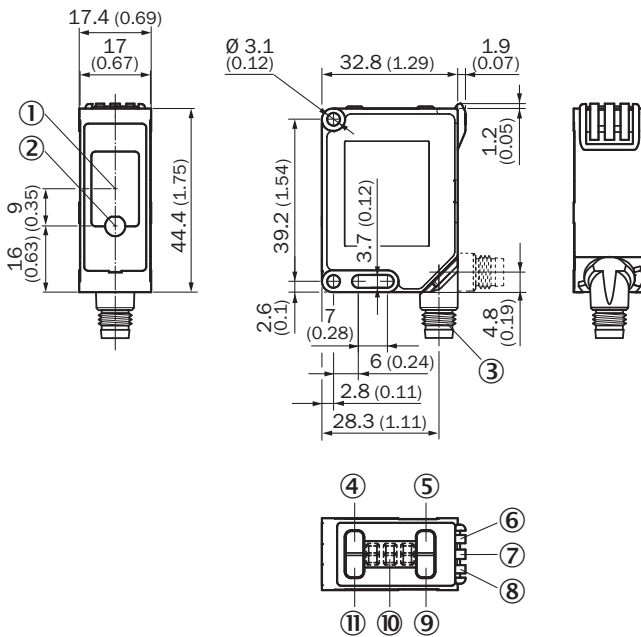

Dimensional drawing (Dimensions in mm (inch))



- ① Receiver
- ② Sender
- ③ Connection
- ④ RUN button
- ⑤ (+/Q2) button
- ⑥ Status indicator orange: Q2 output indicator
- ⑦ Status indicator LED, green/red: power on / stability indicator
- ⑧ Status indicator orange: Q1 output indicator
- ⑨ (-/Q1) button
- ⑩ Display
- ⑪ SET button

Recommended accessories

Other models and accessories → www.sick.com/PowerProx

	Brief description	Type	Part no.
Plug connectors and cables			
	Head A: female connector, M8, 4-pin, straight, A-coded Head B: Flying leads Cable: Sensor/actuator cable, PVC, unshielded, 5 m	YF8U14-050VA3XLEAX	2095889
	Head A: male connector, M8, 4-pin, straight Head B: - Cable: unshielded	STE-0804-G	6037323

SICK AT A GLANCE

SICK is one of the leading manufacturers of intelligent sensors and sensor solutions for industrial applications. A unique range of products and services creates the perfect basis for controlling processes securely and efficiently, protecting individuals from accidents and preventing damage to the environment.

We have extensive experience in a wide range of industries and understand their processes and requirements. With intelligent sensors, we can deliver exactly what our customers need. In application centers in Europe, Asia and North America, system solutions are tested and optimized in accordance with customer specifications. All this makes us a reliable supplier and development partner.

Comprehensive services complete our offering: SICK LifeTime Services provide support throughout the machine life cycle and ensure safety and productivity.

For us, that is “Sensor Intelligence.”

WORLDWIDE PRESENCE:

Contacts and other locations –www.sick.com