



WTT280L-2P2531

PowerProx

MULTITASK PHOTOELECTRIC SENSORS

SICK
Sensor Intelligence.



Ordering information

Type	Part no.
WTT280L-2P2531	6048061

Included in delivery: BEF-W280 (1)

Other models and accessories → www.sick.com/PowerProx

Illustration may differ



Detailed technical data

Features

Sensor/ detection principle	Photoelectric proximity sensor, Background suppression
Dimensions (W x H x D)	23.5 mm x 76 mm x 55.8 mm
Housing design (light emission)	Rectangular
Sensing range max.	200 mm ... 4,000 mm ¹⁾ 200 mm ... 3,000 mm ²⁾
Sensing range	200 mm ... 4,000 mm ^{1) 3)} 200 mm ... 3,000 mm ^{2) 3)}
Type of light	Visible red light
Light source	Laser ⁴⁾
Light spot size (distance)	Ø 12 mm (3 m)
Laser class	1 (EN 60825-1:2014, IEC 60825-1:2014)
Adjustment	Potentiometer (1 x)
Special applications	Detecting small objects

¹⁾ Object with 90 % reflectance (referred to standard white, DIN 5033).

²⁾ Objects to be sensed with 6 % reflectivity (based on black).

³⁾ Einstellbar.

⁴⁾ Average service life: 100,000 h at T_U = +25 °C.

Mechanics/electronics

Supply voltage	10 V DC ... 30 V DC ¹⁾
Ripple	$\leq 3 V_{pp}$
Current consumption	70 mA ²⁾
Switching output	PNP
Number of switching outputs	1 (Q ₁) ³⁾
Switching mode	Light/dark switching
Switching mode selector	Selectable via light/dark rotary switch
Output current I_{max.}	≤ 100 mA
Response time	≤ 0.5 ms ⁴⁾
Switching frequency	1,000 Hz ⁵⁾
Analog output	-
Input	Sender off
Connection type	Male connector M12, 5-pin
Circuit protection	A ⁶⁾ B ⁷⁾ C ⁸⁾ D ⁹⁾
Protection class	III
Weight	120 g
Housing material	Plastic, ABS
Optics material	Plastic, PMMA
Enclosure rating	IP67
Items supplied	Mounting bracket BEF-W280
EMC	EN 60947-5-2
Ambient operating temperature	-10 °C ... +50 °C
Ambient storage temperature	-40 °C ... +70 °C
UL File No.	NRKH2.E300503 & NRKH8.E300503

¹⁾ Limit values. Operated in short-circuit protected network: max. 8 A.

²⁾ Without load.

³⁾ Q₁ = 1 switching threshold, light/dark switching selectable via light/dark selector.

⁴⁾ Signal transit time with resistive load.

⁵⁾ With light/dark ratio 1:1.

⁶⁾ A = V_S connections reverse-polarity protected.

⁷⁾ B = output reverse-polarity protected.

⁸⁾ C = interference suppression.

⁹⁾ D = outputs overcurrent and short-circuit protected.

Safety-related parameters

MTTF_D	201 years
DC_{avg}	0%

Classifications

ECl@ss 5.0	27270904
ECl@ss 5.1.4	27270904

ECl@ss 6.0	27270904
ECl@ss 6.2	27270904
ECl@ss 7.0	27270904
ECl@ss 8.0	27270904
ECl@ss 8.1	27270904
ECl@ss 9.0	27270904
ECl@ss 10.0	27270904
ECl@ss 11.0	27270904
ETIM 5.0	EC002719
ETIM 6.0	EC002719
ETIM 7.0	EC002719
UNSPSC 16.0901	39121528

Connection diagram

Cd-210

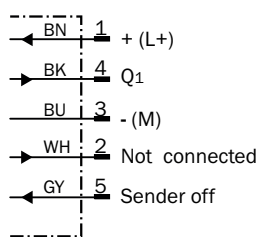

Characteristic curve

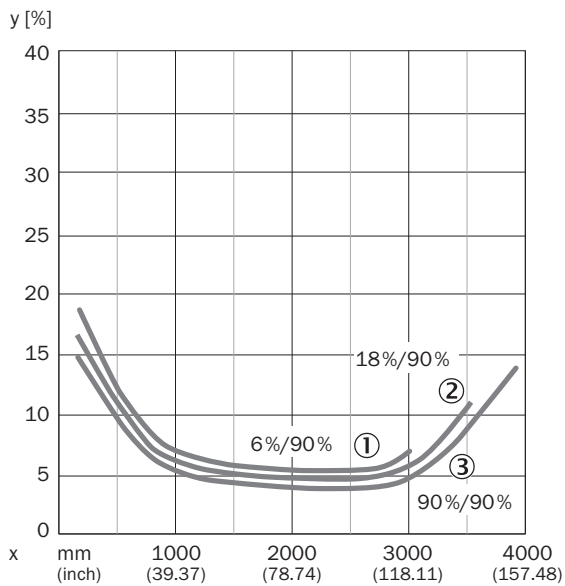

- ① Sensing range on black, 6% remission
- ② Sensing range on gray, 18% remission
- ③ Sensing range on white, 90% remission

Sensing range diagram

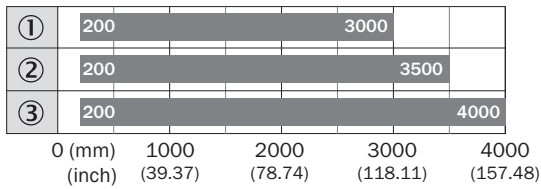

■ Sensing range max.

- ① Sensing range on black, 6% remission
- ② Sensing range on gray, 18 % remission
- ③ Sensing range on white, 90% remission

Adjustments possible

WTT280L-2xxxx1

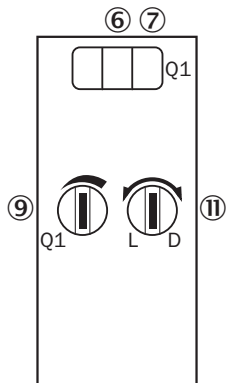

- ⑥ LED indicator green: Stability indicator
- ⑦ LED indicator yellow: Status of received light beam
- ⑨ Sensing range adjustment: potentiometer
- ⑪ Light/dark selector

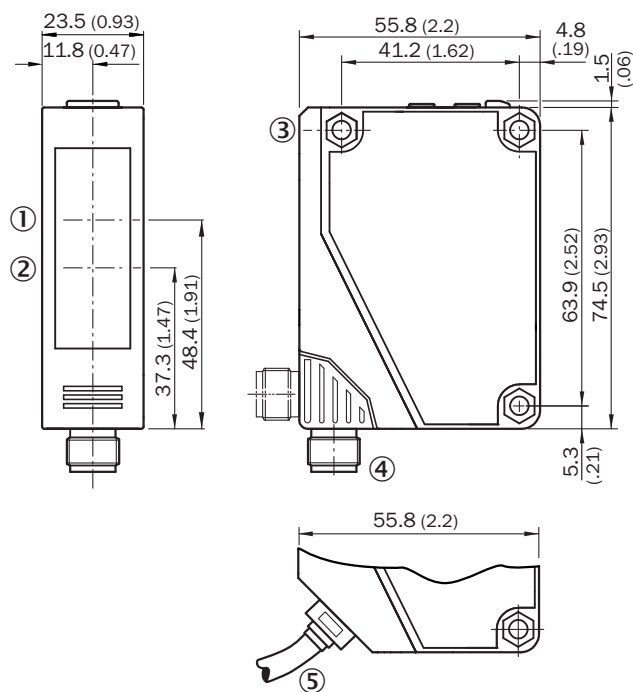

Dimensional drawing (Dimensions in mm (inch))



- ① Center of optical axis, receiver
- ② Center of optical axis, sender
- ③ Mounting hole, Ø 4.3 mm
- ④ M12 plug connector, 5-pin, can be rotated through 90°
- ⑤ Cable, 2 m, 5-wire, Ø 3.8 mm

Recommended accessories

Other models and accessories → www.sick.com/PowerProx

	Brief description	Type	Part no.
Mounting brackets and plates			
	Mounting bracket, Stainless steel V2A (1.4301)	BEF-W280	5313885
Plug connectors and cables			
	Head A: female connector, M12, 5-pin, straight, A-coded Head B: Flying leads Cable: Sensor/actuator cable, PVC, unshielded, 5 m	YF2A15-050VB5XLEAX	2096240
	Head A: male connector, M12, 5-pin, straight Cable: unshielded For field bus technology	STE-1205-G	6022083

SICK AT A GLANCE

SICK is one of the leading manufacturers of intelligent sensors and sensor solutions for industrial applications. A unique range of products and services creates the perfect basis for controlling processes securely and efficiently, protecting individuals from accidents and preventing damage to the environment.

We have extensive experience in a wide range of industries and understand their processes and requirements. With intelligent sensors, we can deliver exactly what our customers need. In application centers in Europe, Asia and North America, system solutions are tested and optimized in accordance with customer specifications. All this makes us a reliable supplier and development partner.

Comprehensive services complete our offering: SICK LifeTime Services provide support throughout the machine life cycle and ensure safety and productivity.

For us, that is “Sensor Intelligence.”

WORLDWIDE PRESENCE:

Contacts and other locations –www.sick.com