

MW Series Control Units



ø22 MW Series Control Units

IP66 waterproof and dust-proof enclosure Suitable for installation in harsh environment, such as construction machines

- Prevents entry of sand and dust.
- Reliable operation under high operation load
- Solder/tab terminal #187
- Various pushbuttons, selector switches and screw terminal sockets are available.
- Degree of protection: IP66 (IEC 60529)
- EN compliant and CCC approved.



Specifications

Standard Operating Condition	Operating temperature: -25 to +70°C (no freezing) Storage Condition: -30 to +80°C (no freezing) Relative humidity: 45 to 85% RH (no condensation)
Contact Resistance	50 mΩ maximum (initial value)
Insulation Resistance	100 MΩ minimum (500V DC by megger)
Dielectric Strength	Between live and dead metal parts: 2500V AC, 1 minute Between live parts of different poles: 2500V AC, 1 minute
Vibration Resistance	Damage limits, operating extremes: 5 to 55 Hz, amplitude 0.5 mm
Shock Resistance	Damage limits: 1,000 m/s ² Operating extremes: 100 m/s ²
Mechanical Life	Momentary: 500,000 operations minimum Maintained: 250,000 operations minimum Selector switch: 250,000 operations minimum
Electrical Life	1,00,000 operations minimum (Switching frequency: 1200 operations/hour)
Degree of Protection	IP66 (IEC 60529)
Terminal Style	Solder/tab terminal #187
Weight (Approx.)	Pushbutton: Flush 30g, Mushroom 35g Selector switch: 35g



Contact Ratings



Insulation Voltage		125V	
Thermal Current		10A	
Operational Voltage		24V	110V
Operational Current	AC, 50/60 Hz	Resistive Load AC-12	—
		Inductive Load AC-15	—
	DC	Resistive Load DC-12	8A
		Inductive Load DC-13	5A
Contact Material		Silver	

• The operational current is indicated in the classification of the closed circuit and breaking current under JIS C4520-1991. The test conditions of this classification are as follows.

1. Power factor of AC inductive load in closed circuit is 0.4 ±0.05.
The closed circuit current is 50A (10 times as large as the operational current) and the power factor is 0.7 ±0.05.
2. Time constant of DC inductive load is T0.95 = 300 ms.

MW1B Pushbuttons

Package Quantity: 1

Shape	Operation	Contact	Part No.	Button Color Code
	Momentary	SPDT	MW1B-M11*	B (black)
		DPDT	MW1B-M12*	G (green)
	Maintained	SPDT	MW1B-A11*	R (red)
		DPDT	MW1B-A12*	S (blue)
				W (white)
	Momentary	SPDT	MW1B-M31*	B (black)
		DPDT	MW1B-M32*	G (green)
	Maintained	SPDT	MW1B-A31*	R (red)
		DPDT	MW1B-A32*	Y (yellow)

• Specify a button color code in place of * in the Part No.

Mounting Hole Layout

Flush

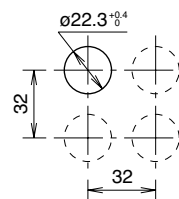

Mushroom

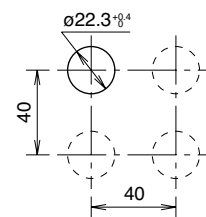

Note: Determine the mounting centers to ensure easy operation.

Dimensions

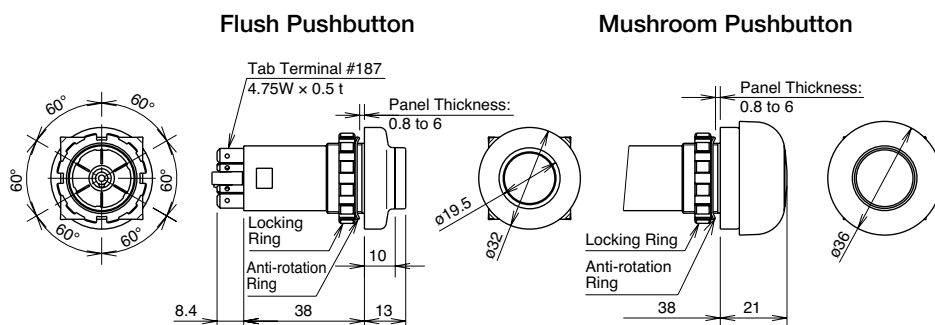

Terminal Arrangement (Bottom View)

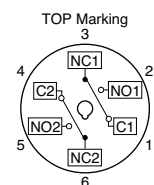







Note: 1 to 6 indicate terminal numbers shown on the side of the housing.
• SPDT has only NC1, NO1, and C1.

All dimensions in mm.

MW1S Selector Switches

Package Quantity: 1

Shape	No. of Positions	Operator Position	No. of Contacts	Part No.
 Knob Operator	90° 2-Position	 Maintained	DPDT	MW1S-2Y2
	55° 3-Position	 Maintained	DPDT	MW1S-3Y2
 Lever Operator	90° 2-Position	 Maintained	DPDT	MW1S-2L2
	55° 3-Position	 Maintained	DPDT	MW1S-3L2

• Operator color: White indicator on black knob or lever.

Mounting Hole Layout

Knob Operator

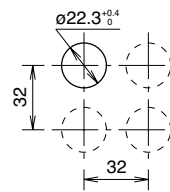

Lever Operator

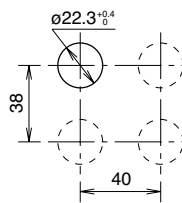

Terminal Arrangement (Bottom View)

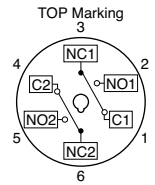

Note: Determine the mounting center to ensure easy operation.

Note: 1 to 6 indicate terminal numbers shown on the side of the housing.

Dimensions

Knob Operator

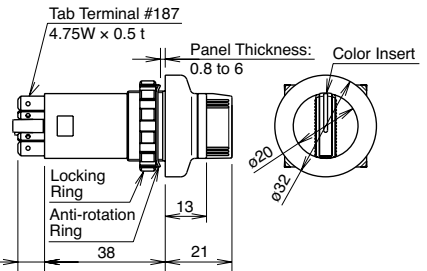

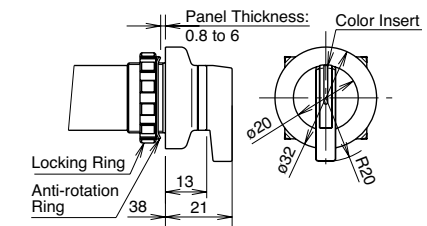

Lever Operator







All dimensions in mm.

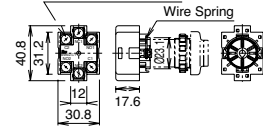
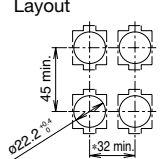
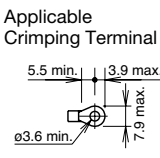

Contact Operation

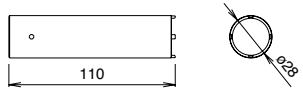
Position	Contact	Operator Position and Contact Operation (Top View)			
		Left		Center	Right
 90° 2-Position Maintained	DPDT	Left Contact: VO NC Right Contact: NO NC	—	Left Contact: IO NC Right Contact: NO NC	
 55° 3-Position Maintained	DPDT	Left Contact: VO NC Right Contact: NO NC	Left Contact: IO NC Right Contact: NO NC	Left Contact: IO NC Right Contact: NO NC	

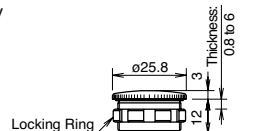
Accessories

Name/Shape	Specifications	Part No.	Ordering No.	Package Quantity	Remarks
 Screw Terminal Socket	Applicable wire for screw terminal: 2 mm ² x 2 wires Weight: Approx. 27g	MW9Z-C1N	MW9Z-C1N	1	<ul style="list-style-type: none"> Quick attachment  <p>Note 1: For mushroom pushbuttons and lever selector, the dimension with * should be 40 mm or more.</p> <p>Note 2: Determine the mounting centers in consideration of accessibility during wiring and safety. Particularly when a crimping terminal is used, be careful about the dimensions of the crimping terminal.</p>  
 Locking Ring Wrench	Metal Weight: Approx. 150g	MW9Z-T1	MW9Z-T1	1	<ul style="list-style-type: none"> Locking ring wrench used for mounting the unit into the panel cut out. 
 Mounting Hole Plug	Diecast Metal (Locking ring: polyamide) Weight: Approx. 18g	LW9Z-BM	LW9Z-BM	1	<ul style="list-style-type: none"> Used to fill any unnecessary mounting holes in a panel. Tightening torque for the locking ring: 1.2 N·m Degree of protection: IP65 

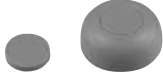
Maintenance Parts

Name/Shape	Specifications	Part No.	Ordering No.	Package Quantity	Remarks
	For flush	ABS1BN-*	ABS1BN-*PN05	10	Specify a color code in place of * in the Ordering No. B (Black), G (Green), R (Red), S (Blue), W (White), Y (Yellow)
	For mushroom	MW9Z-B13*	MW9Z-B13*PN02	10	Specify a color code in place of * in the Ordering No. B (Black), G (Green), R (Red), Y (Yellow)
	For selector	HA9Z-HC1*	HA9Z-HC1*PN05	5	Specify a color code in place of * in the Ordering No. G (Green), R (Red), S (Blue), W (White), Y (Yellow)
	Metal	MW9Z-LN	MW9Z-LN	1	—

Safety Precautions

- Turn off power to the switch before installation, removal, wiring, maintenance, and inspection. Failure to turn power off may cause electrical shocks or fire hazard.
- For wiring, use wires of proper size to meet the voltage and current requirements. Tighten the M3.5 terminal screws of the screw terminal socket to a tightening torque of 1.0 to 1.3 N·m. If the terminal screw is incompletely soldered or loose, the terminal may heat up, causing a fire.

Instructions

Panel Mounting

1. Remove the locking ring and the anti-rotation ring, and insert the unit into the panel cut-out.

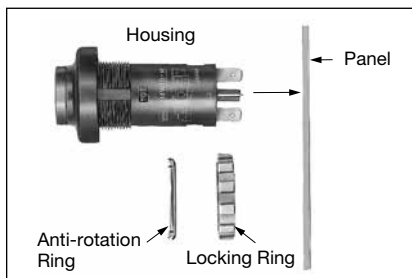

2. After inserting the unit, install the anti-rotation ring and the locking ring to the housing in this sequence.

Note: Be careful about orientation of the anti-rotation ring.

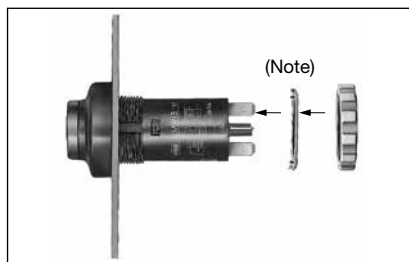

Notes on Panel Mounting

When mounting the operator onto a panel, use the optional locking ring wrench (MW9Z-T1) to tighten the locking ring. Tightening torque must not exceed 4.0 N·m. Do not use pliers. Excessive tightening will damage the locking ring. Recommended tightening torque: 2 to 4 N·m

Other Notes

Installing Nameplate

Do not install a nameplate between the panel front surface and the rubber boot. If a nameplate of this type is installed, then the degree of protection will be degraded. Directly attach a nameplate to the panel surface.

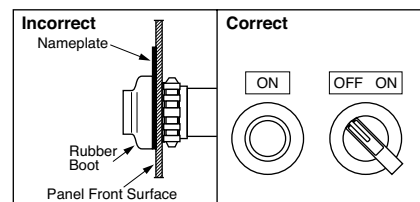

Oil-proof Characteristics

The oil-proof rating of the MW series unit is intended for general-purpose coolant oil. The MW series unit may not be used for certain oils. Contact IDEC for more information.

Notes on Wiring

Solder the terminal at 350°C within 3 seconds, using a 60W soldering iron. Sn-Ag-Cu solder is recommended. When soldering, do not touch the switch housing with the soldering iron. Also ensure that no tensile force is applied to the terminals. Do not bend the terminals or apply excessive force to the terminals. Use a non-corrosive rosin flux.

Specifications and other descriptions in this brochure are subject to change without notice.



IDEC CORPORATION

IDEC CORPORATION (USA)
 Tel: +1-408-747-0550 / (800) 262-IDEC (4332)
 E-mail: opencontact@idec.com
IDEC CANADA LIMITED
 Tel: +1-905-890-8561, Toll Free: (888) 262-IDEC (4332)
 E-mail: sales@ca.idec.com
IDEC AUSTRALIA PTY. LTD.
 Tel: +61-3-8523-5900, Toll Free: 1800-68-4332
 E-mail: sales@au.idec.com

IDEC ELEKTROTECHNIK GmbH
 Tel: +49-40-25 30 54 - 0 E-mail: service@eu.idec.com
IDEC (SHANGHAI) CORPORATION
 Tel: +86-21-6135-1515 E-mail: idec@cn.idec.com
IDEC (BEIJING) CORPORATION
 Tel: +86-10-6581-6131
IDEC (SHENZHEN) CORPORATION
 Tel: +86-755-8356-2977

6-64, Nishi-Miyahara 2-Chome, Yodogawa-ku, Osaka 532-0004, Japan
 Tel: +81-6-6398-2571, Fax: +81-6-6392-9731, E-mail: marketing@idec.co.jp

IDEC IZUMI (H.K.) CO., LTD.
 Tel: +852-2803-8989 E-mail: info@hk.idec.com
IDEC TAIWAN CORPORATION
 Tel: +886-2-2698-3929 E-mail: service@tw.idec.com
IDEC IZUMI ASIA PTE. LTD.
 Tel: +65-6746-1155 E-mail: info@sg.idec.com
IDEC ASIA (THAILAND) CO., LTD.
 Tel: +662-392-9765, E-mail: sales@th.idec.com