



WTB2S-2P3151

W2S-2

MINIATURE PHOTOELECTRIC SENSORS

SICK
Sensor Intelligence.



Ordering information

| Type | Part no. |
|--------------|----------|
| WTB2S-2P3151 | 1067502 |

Other models and accessories → www.sick.com/W2S-2

Illustration may differ



Detailed technical data

Features

| | |
|--|--|
| Sensor/ detection principle | Photoelectric proximity sensor, Background suppression |
| Dimensions (W x H x D) | 7.7 mm x 27.5 mm x 13.5 mm |
| Housing design (light emission) | Rectangular |
| Sensing range max. | 1 mm ... 150 mm ¹⁾ |
| Sensing range | 18 mm ... 110 mm ¹⁾ |
| Type of light | Visible red light |
| Light source | PinPoint LED ²⁾ |
| Light spot size (distance) | Ø 3.5 mm (50 mm) |
| Wave length | 640 nm |
| Adjustment | Potentiometer, 3 turns |
| Special applications | Detecting small objects |

¹⁾ Object with 90 % reflectance (referred to standard white, DIN 5033).

²⁾ Average service life: 100,000 h at T_J = +25 °C.

Mechanics/electronics

| | |
|--|---|
| Supply voltage | 10 V DC ... 30 V DC ¹⁾ |
| Ripple | $\leq 5 V_{pp}$ ²⁾ |
| Current consumption | 20 mA ³⁾ |
| Switching output | PNP |
| Switching mode | Light switching |
| Output current I_{max} | < 50 mA |
| Response time | < 0.5 ms ⁴⁾ |
| Switching frequency | 1,000 Hz ⁵⁾ |
| Connection type | Cable with connector M8, 3-pin, 200 mm ⁶⁾ |
| Cable material | PVC |
| Cable diameter | Ø 3 mm |
| Circuit protection | A ⁷⁾ B ⁸⁾ D ⁹⁾ |
| Housing material | Plastic, ABS/PC |
| Optics material | Plastic, PMMA |
| Enclosure rating | IP67 |
| Ambient operating temperature | -25 °C ... +50 °C |
| Ambient storage temperature | -40 °C ... +75 °C |
| UL File No. | NRKH.E181493 |

1) Limit values.

2) May not exceed or fall below U_v tolerances.

3) Without load.

4) Signal transit time with resistive load.

5) With light/dark ratio 1:1.

6) Do not bend below 0 °C.

7) A = V_S connections reverse-polarity protected.

8) B = output reverse-polarity protected.

9) D = outputs overcurrent and short-circuit protected.

Safety-related parameters

| | |
|-------------------------|-------------|
| MTTF_D | 3,138 years |
| DC_{avg} | 0% |

Classifications

| | |
|---------------------|----------|
| ECl@ss 5.0 | 27270904 |
| ECl@ss 5.1.4 | 27270904 |
| ECl@ss 6.0 | 27270904 |
| ECl@ss 6.2 | 27270904 |
| ECl@ss 7.0 | 27270904 |
| ECl@ss 8.0 | 27270904 |
| ECl@ss 8.1 | 27270904 |
| ECl@ss 9.0 | 27270904 |

| | |
|-----------------------|----------|
| ECl@ss 10.0 | 27270904 |
| ECl@ss 11.0 | 27270904 |
| ETIM 5.0 | EC002719 |
| ETIM 6.0 | EC002719 |
| ETIM 7.0 | EC002719 |
| UNSPSC 16.0901 | 39121528 |

Connection diagram

Cd-045

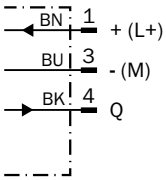

Characteristic curve

WTB2S-2, 150 mm

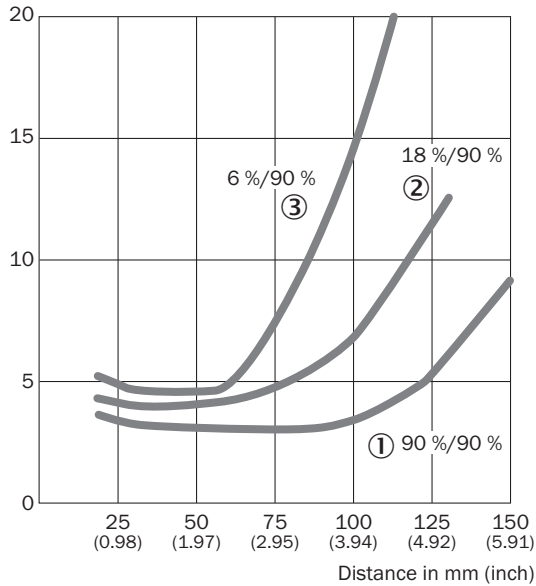

- ① Sensing range on white, 90% remission
- ② Sensing range on gray, 18 % remission
- ③ Sensing range on black, 6% remission

Light spot size

WTB2S-2, 150 mm

Spot diameter in mm (inch)

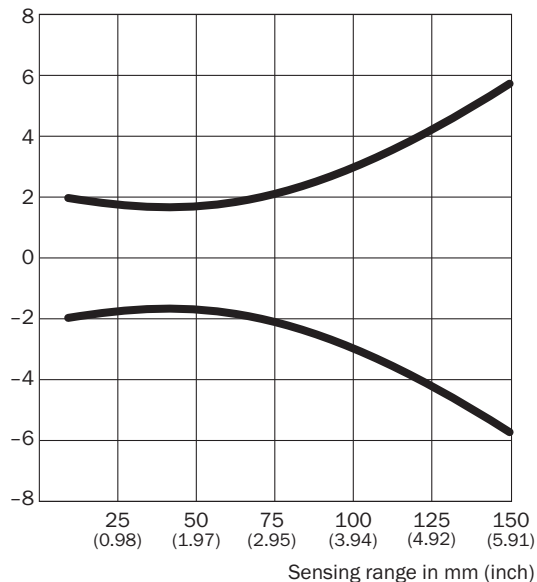

Dimensions in mm (inch)

| Sensing range | Spot diameter |
|-----------------------------|----------------|
| 10 (0.39) | 4.0 (0.16) |
| 20 (0.79) | 3.7 (0.15) |
| 40 (1.57) | 3.4 (0.13) |
| 80 (3.15) | 4.4 (0.17) |
| 120 (4.72) | 8.0 (0.31) |
| 150 (5.91) | 11.5 (0.45) |

Sensing range diagram

WTB2S-2, 150 mm

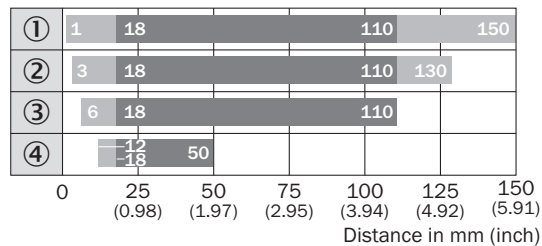

■ Sensing range ■ Sensing range max.

- ① Sensing range on white, 90% remission
- ② Sensing range on gray, 18% remission
- ③ Sensing range on black, 6% remission
- ④ Sensing range on ultra black, 1% remission

Dimensional drawing (Dimensions in mm (inch))

WTB2S-2, 150 mm

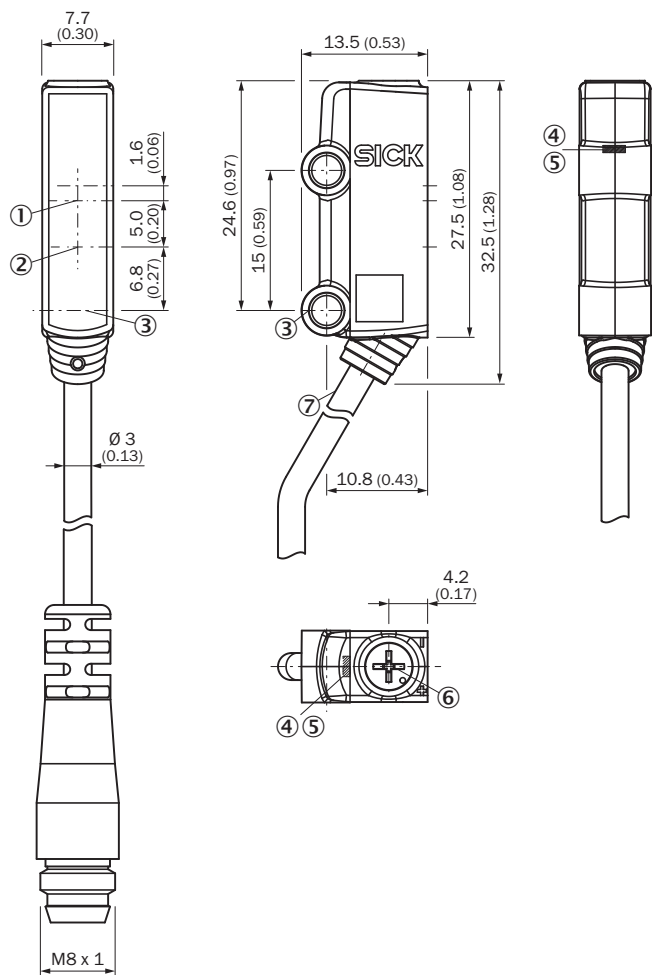

- ① Optical axis, receiver
- ② Optical axis, sender
- ③ Mounting hole, \varnothing 3.2 mm
- ④ LED indicator green: Supply voltage active
- ⑤ LED indicator yellow: Status of received light beam
- ⑥ Potentiometer
- ⑦ Connection

Recommended accessories

Other models and accessories → www.sick.com/W2S-2

| | Brief description | Type | Part no. |
|---|--|--------------------|-----------------|
| Plug connectors and cables | | | |
|  | Head A: female connector, M8, 3-pin, straight, A-coded Head B: Flying leads Cable: Sensor/actuator cable, PVC, unshielded, 5 m | YF8U13-050VA1XLEAX | 2095884 |

| | Brief description | Type | Part no. |
|---|---|-------------|-----------------|
|  | Head A: male connector, M8, 3-pin, straight Head B: - Cable: unshielded | STE-0803-G | 6037322 |

SICK AT A GLANCE

SICK is one of the leading manufacturers of intelligent sensors and sensor solutions for industrial applications. A unique range of products and services creates the perfect basis for controlling processes securely and efficiently, protecting individuals from accidents and preventing damage to the environment.

We have extensive experience in a wide range of industries and understand their processes and requirements. With intelligent sensors, we can deliver exactly what our customers need. In application centers in Europe, Asia and North America, system solutions are tested and optimized in accordance with customer specifications. All this makes us a reliable supplier and development partner.

Comprehensive services complete our offering: SICK LifeTime Services provide support throughout the machine life cycle and ensure safety and productivity.

For us, that is “Sensor Intelligence.”

WORLDWIDE PRESENCE:

Contacts and other locations –www.sick.com