



**WTB4S-3P1232V**

W4S-3 Inox

**MINIATURE PHOTOELECTRIC SENSORS**

**SICK**  
Sensor Intelligence.



Illustration may differ



### Ordering information

Type	Part no.
WTB4S-3P1232V	1052411

Other models and accessories → [www.sick.com/W4S-3\\_Inox](http://www.sick.com/W4S-3_Inox)

### Detailed technical data

#### Features

<b>Sensor/ detection principle</b>	Photoelectric proximity sensor, Background suppression
<b>Dimensions (W x H x D)</b>	15.25 mm x 49.2 mm x 22.2 mm
<b>Housing design</b>	Washdown
<b>Housing design (light emission)</b>	Rectangular
<b>Sensing range max.</b>	4 mm ... 120 mm <sup>1)</sup>
<b>Sensing range</b>	10 mm ... 120 mm <sup>1)</sup>
<b>Type of light</b>	Visible red light
<b>Light source</b>	PinPoint LED <sup>2)</sup>
<b>Light spot size (distance)</b>	Ø 2.5 mm (50 mm)
<b>Wave length</b>	650 nm
<b>Adjustment</b>	Single teach-in button
<b>Special applications</b>	Hygienic and washdown zones

<sup>1)</sup> Object with 90 % reflectance (referred to standard white, DIN 5033).

<sup>2)</sup> Average service life: 100,000 h at T<sub>U</sub> = +25 °C.

Mechanics/electronics

<b>Supply voltage</b>	10 V DC ... 30 V DC <sup>1)</sup>
<b>Ripple</b>	< 5 V <sub>pp</sub> <sup>2)</sup>
<b>Current consumption</b>	30 mA <sup>3)</sup>
<b>Switching output</b>	PNP
<b>Switching mode</b>	Light/dark switching
<b>Output current I<sub>max.</sub></b>	≤ 100 mA
<b>Response time</b>	< 0.5 ms <sup>4)</sup>
<b>Switching frequency</b>	1,000 Hz <sup>5)</sup>
<b>Connection type</b>	Cable, 4-wire, 5 m <sup>6)</sup>
<b>Cable material</b>	PVC
<b>Conductor cross-section</b>	0.14 mm <sup>2</sup>
<b>Circuit protection</b>	A <sup>7)</sup> B <sup>8)</sup> C <sup>9)</sup>
<b>Protection class</b>	III
<b>Weight</b>	125 g
<b>Housing material</b>	Stainless steel, Stainless steel
<b>Enclosure rating</b>	IP66, IP67, IP68, IP69K
<b>Ambient operating temperature</b>	-30 °C ... +70 °C <sup>10)</sup> -30 °C ... +60 °C
<b>Ambient storage temperature</b>	-30 °C ... +75 °C
<b>UL File No.</b>	NRKH.E181493 & NRKH7.E181493

<sup>1)</sup> Limit values, reverse-polarity protected, operation in short-circuit protected network: max. 8 A.

<sup>2)</sup> May not exceed or fall below U<sub>v</sub> tolerances.

<sup>3)</sup> Without load.

<sup>4)</sup> Signal transit time with resistive load.

<sup>5)</sup> With light/dark ratio 1:1.

<sup>6)</sup> Do not bend below 0 °C.

<sup>7)</sup> A = V<sub>S</sub> connections reverse-polarity protected.

<sup>8)</sup> B = inputs and output reverse-polarity protected.

<sup>9)</sup> C = interference suppression.

<sup>10)</sup> At UV ≤ 24 V and IA < 30 mA.

Classifications

<b>ECl@ss 5.0</b>	27270904
<b>ECl@ss 5.1.4</b>	27270904
<b>ECl@ss 6.0</b>	27270904
<b>ECl@ss 6.2</b>	27270904
<b>ECl@ss 7.0</b>	27270904
<b>ECl@ss 8.0</b>	27270904
<b>ECl@ss 8.1</b>	27270904
<b>ECl@ss 9.0</b>	27270904
<b>ECl@ss 10.0</b>	27270904

<b>ECl@ss 11.0</b>	27270904
<b>ETIM 5.0</b>	EC002719
<b>ETIM 6.0</b>	EC002719
<b>ETIM 7.0</b>	EC002719
<b>UNSPSC 16.0901</b>	39121528

### Connection diagram

Cd-094

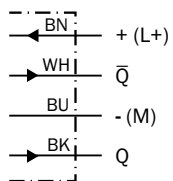

### Characteristic curve

WTB4S-3, 120 mm

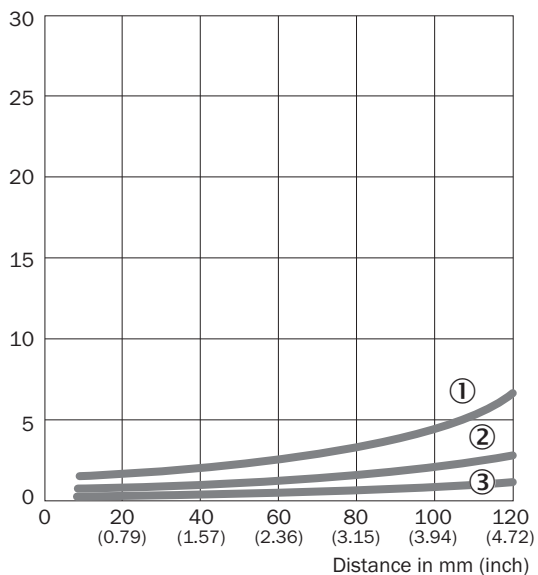

- ① Sensing range on black, 6% remission
- ② Sensing range on gray, 18 % remission
- ③ Sensing range on white, 90% remission

### Light spot size

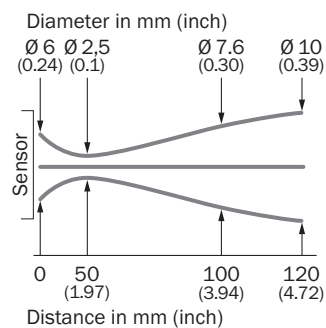

### Sensing range diagram

WTB4S-3, 120 mm

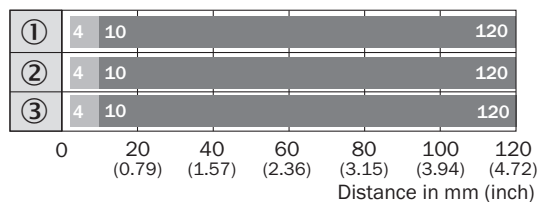

■ Sensing range    ■ Sensing range max.

- ① Sensing range on black, 6% remission
- ② Sensing range on gray, 18 % remission
- ③ Sensing range on white, 90% remission

**Dimensional drawing** (Dimensions in mm (inch))

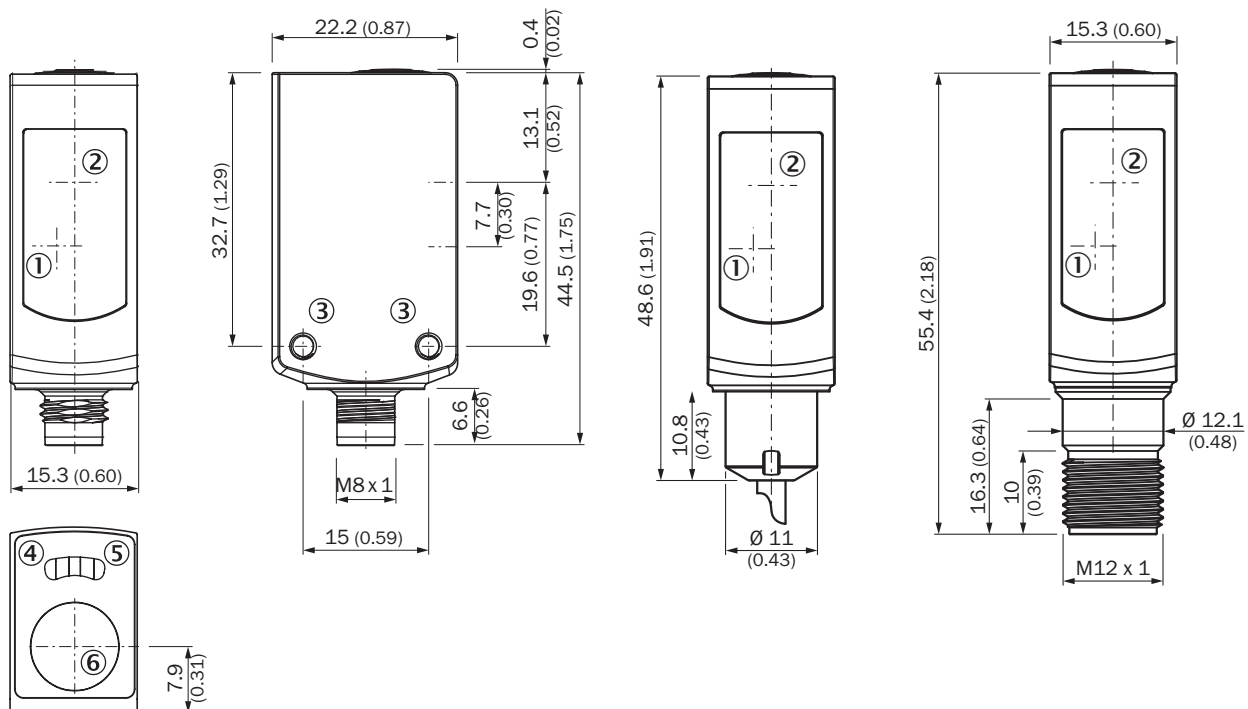

WTB4S-3V, WTF4S-3V, Single teach-in button



- ① Center of optical axis, receiver
- ② Center of optical axis, sender
- ③ Threaded mounting hole M3
- ④ LED indicator yellow: Status of received light beam
- ⑤ LED indicator green: Supply voltage active
- ⑥ Teach-in button

**Recommended accessories**

Other models and accessories → [www.sick.com/W4S-3\\_Inox](http://www.sick.com/W4S-3_Inox)

	<b>Brief description</b>	<b>Type</b>	<b>Part no.</b>
<b>Mounting brackets and plates</b>			
	Mounting bracket for floor mounting, Stainless steel 1.4571, mounting hardware included	BEF-W4-B	2051630
<b>Plug connectors and cables</b>			
	Head A: male connector, M8, 4-pin, straight Head B: - Cable: unshielded	STE-0804-G	6037323

## SICK AT A GLANCE

SICK is one of the leading manufacturers of intelligent sensors and sensor solutions for industrial applications. A unique range of products and services creates the perfect basis for controlling processes securely and efficiently, protecting individuals from accidents and preventing damage to the environment.

We have extensive experience in a wide range of industries and understand their processes and requirements. With intelligent sensors, we can deliver exactly what our customers need. In application centers in Europe, Asia and North America, system solutions are tested and optimized in accordance with customer specifications. All this makes us a reliable supplier and development partner.

Comprehensive services complete our offering: SICK LifeTime Services provide support throughout the machine life cycle and ensure safety and productivity.

For us, that is “Sensor Intelligence.”

## WORLDWIDE PRESENCE:

Contacts and other locations –[www.sick.com](http://www.sick.com)