



RT-P1233

ZoneControl

MULTITASK PHOTOELECTRIC SENSORS

SICK
Sensor Intelligence.



Illustration may differ



Ordering information

| Type | Part no. |
|----------|----------|
| RT-P1233 | 1063136 |

Other models and accessories → www.sick.com/ZoneControl

Detailed technical data

Features

| | |
|------------------------------------|--|
| Sensor/ detection principle | Photoelectric proximity sensor, Background suppression |
| Dimensions (W x H x D) | 20.6 mm x 99.2 mm x 48.9 mm |
| Sensing range max. | 60 mm ... 900 mm |
| Sensing range | 60 mm ... 900 mm |
| Type of light | Infrared light |
| Light source | LED ¹⁾ |
| Light spot size (distance) | Ø 20 mm (500 mm) |
| Angle of dispersion | 7° |
| Adjustment | Potentiometer, 9 turns |
| Special applications | ZoneControl |

¹⁾ Average service life: 100,000 h at T_U = +25 °C.

Mechanics/electronics

| | |
|----------------------------|-----------------------------------|
| Supply voltage | 10 V DC ... 30 V DC ¹⁾ |
| Ripple | < 5 V _{pp} ²⁾ |
| Current consumption | 20 mA ³⁾ |
| Switching output | PNP |
| Switching mode | Light switching |

¹⁾ Limit values.

²⁾ May not exceed or fall below U_v tolerances.

³⁾ Without load and valve deenergized.

⁴⁾ Do not bend below 0 °C.

⁵⁾ A = V_S connections reverse-polarity protected.

⁶⁾ C = interference suppression.

⁷⁾ D = outputs overcurrent and short-circuit protected.

| | |
|---|--|
| Signal voltage PNP HIGH/LOW | Approx. $V_S - 0.5 \text{ V} / 0 \text{ V}$ |
| Output current I_{\max} | $\leq 100 \text{ mA}$ |
| Response time | 2 ms |
| Switching frequency | 250 Hz |
| Connection type | Cable with M12 male connector, 4-pin, 300 mm ⁴⁾ |
| Circuit protection | A ⁵⁾ C ⁶⁾ D ⁷⁾ |
| Protection class | III |
| Weight | 175 g |
| Housing material | Plastic, ABS |
| Enclosure rating | IP67 |
| Shock and vibration resistance | According to IEC 68 |
| Ambient operating temperature | -40 °C ... +60 °C |
| Ambient storage temperature | -40 °C ... +75 °C |
| UL File No. | NRKH.E189383 & NRKH7.E189383 |

- 1) Limit values.
- 2) May not exceed or fall below U_V tolerances.
- 3) Without load and valve deenergized.
- 4) Do not bend below 0 °C.
- 5) A = V_S connections reverse-polarity protected.
- 6) C = interference suppression.
- 7) D = outputs overcurrent and short-circuit protected.

Safety-related parameters

| | |
|-------------------------|-------------|
| MTTF_D | 1,525 years |
| DC_{avg} | 0% |

Classifications

| | |
|-----------------------|----------|
| ECl@ss 5.0 | 27270904 |
| ECl@ss 5.1.4 | 27270904 |
| ECl@ss 6.0 | 27270904 |
| ECl@ss 6.2 | 27270904 |
| ECl@ss 7.0 | 27270904 |
| ECl@ss 8.0 | 27270904 |
| ECl@ss 8.1 | 27270904 |
| ECl@ss 9.0 | 27270904 |
| ECl@ss 10.0 | 27270904 |
| ECl@ss 11.0 | 27270904 |
| ETIM 5.0 | EC002719 |
| ETIM 6.0 | EC002719 |
| ETIM 7.0 | EC002719 |
| UNSPSC 16.0901 | 39121528 |

Connection diagram

Cd-259

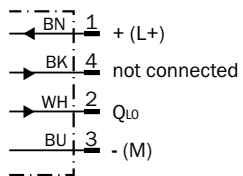

Characteristic curve

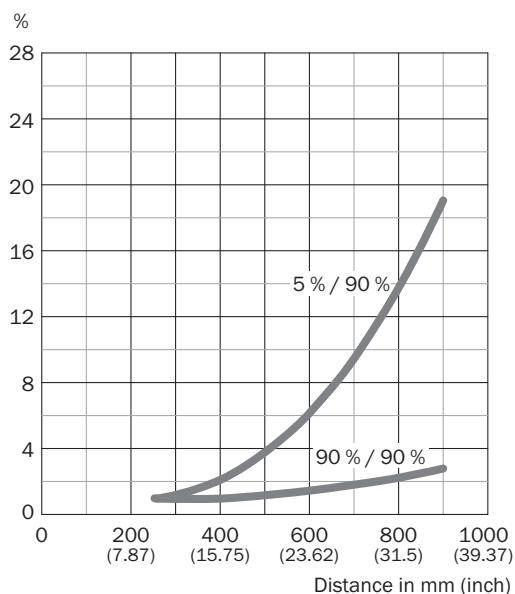

Light spot size

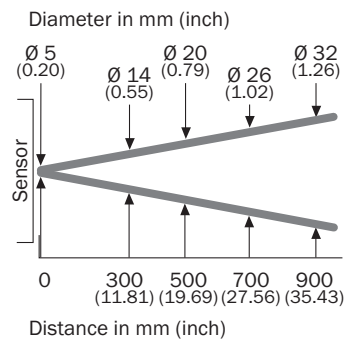

Dimensional drawing (Dimensions in mm (inch))



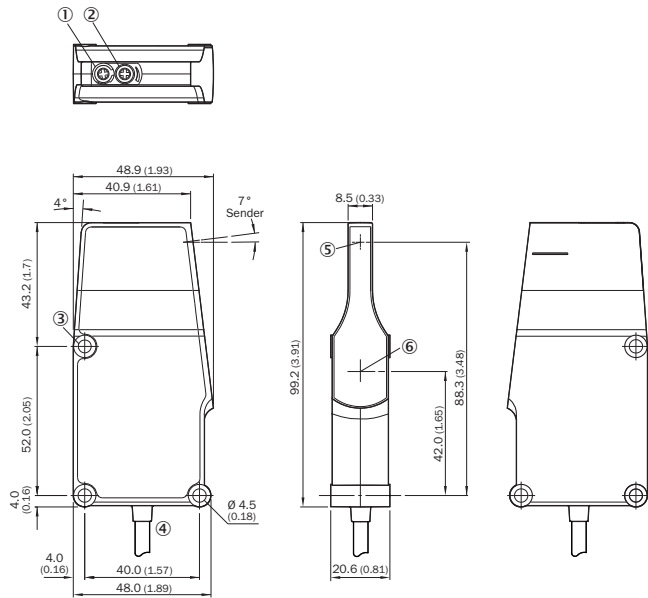

R cable



- ① LED
- ② Potentiometer
- ③ Fixing hole
- ④ Cable
- ⑤ Center of optical axis, sender
- ⑥ Center of optical axis, receiver

Recommended accessories

Other models and accessories → www.sick.com/ZoneControl

| | Brief description | Type | Part no. |
|---|---|--------------------|-----------------|
| Mounting brackets and plates | | | |
|  | Mounting bracket, steel, zinc coated, mounting hardware included | BEF-WK-WTR | 2051786 |
|  | | BEF-WN-IR | 2074621 |
| Plug connectors and cables | | | |
|  | Head A: female connector, M12, 4-pin, straight, A-coded Head B: Flying leads Cable: Sensor/actuator cable, PVC, unshielded, 5 m | YF2A14-050VB3XLEAX | 2096235 |
|  | Head A: male connector, M12, 4-pin, straight Head B: - Cable: unshielded | STE-1204-G | 6009932 |

SICK AT A GLANCE

SICK is one of the leading manufacturers of intelligent sensors and sensor solutions for industrial applications. A unique range of products and services creates the perfect basis for controlling processes securely and efficiently, protecting individuals from accidents and preventing damage to the environment.

We have extensive experience in a wide range of industries and understand their processes and requirements. With intelligent sensors, we can deliver exactly what our customers need. In application centers in Europe, Asia and North America, system solutions are tested and optimized in accordance with customer specifications. All this makes us a reliable supplier and development partner.

Comprehensive services complete our offering: SICK LifeTime Services provide support throughout the machine life cycle and ensure safety and productivity.

For us, that is “Sensor Intelligence.”

WORLDWIDE PRESENCE:

Contacts and other locations –www.sick.com