



HTB18L-P4A5BB

SureSense

HYBRID PHOTOELECTRIC SENSORS

SICK
Sensor Intelligence.



Illustration may differ



Ordering information

Type	Part no.
HTB18L-P4A5BB	1073611

Other models and accessories → www.sick.com/SureSense

Detailed technical data

Features

Device version	Standard
Sensor/ detection principle	Photoelectric proximity sensor, Background suppression
Dimensions (W x H x D)	16.2 mm x 48.5 mm x 31.8 mm
Housing design (light emission)	Hybrid
Thread diameter (housing)	M18
Mounting system type	M18, nose / side (24.1 ... 25.4 mm)
Housing color	Blue
Sensing range max.	30 mm ... 300 mm ¹⁾
Sensing range	30 mm ... 250 mm ²⁾
Type of light	Visible red light
Light source	Laser ^{3) 4)}
Light spot size (distance)	2 mm (120 mm)
Wave length	655 nm
Laser class	I
Adjustment	
	Potentiometer, right Sensing range
	Potentiometer, left None
Special applications	Detecting small objects

¹⁾ Object with 90 % reflectance (referred to standard white, DIN 5033).

²⁾ Object with 6 % reflectance (referred to standard black, DIN 5033).

³⁾ Average service life: 50,000 h at T_U = +25 °C.

⁴⁾ CLASS 1 LASER PRODUCT EN60825-1:2014, IEC60825-1:2014, Maximum pulse power < 2,5 mW, Pulse length: 4 μs, Wavelength: 650 ... 670 nm, Complies with 21 CFR 1040.10 and 1040.11 except for deviations pursuant to Laser Notice No. 50, dated June 24, 2007.

Special features	Signal strength light bar
-------------------------	---------------------------

- 1) Object with 90 % reflectance (referred to standard white, DIN 5033).
 2) Object with 6 % reflectance (referred to standard black, DIN 5033).
 3) Average service life: 50,000 h at $T_J = +25 \text{ }^\circ\text{C}$.
 4) CLASS 1 LASER PRODUCT EN60825-1:2014, IEC60825-1:2014, Maximum pulse power < 2,5 mW, Pulse length: 4 μs , Wavelength: 650 ... 670 nm, Complies with 21 CFR 1040.10 and 1040.11 except for deviations pursuant to Laser Notice No. 50, dated June 24, 2007.

Mechanics/electronics

Supply voltage	10 V DC ... 30 V DC
Ripple	< 5 V_{pp} ¹⁾
Current consumption	20 mA ²⁾
Switching output	PNP
Output function	Complementary
Switching mode	Light/dark switching
Switching output detail	
Switching output Q1	PNP, Light switching
Switching output Q2	PNP, Dark switching
Output current I_{max}	$\leq 100 \text{ mA}$
Response time	$\leq 0.5 \text{ ms}$ ³⁾
Switching frequency	1,000 Hz ⁴⁾
Connection type	Male connector M12, 4-pin
Circuit protection	A ⁵⁾ B ⁶⁾ D ⁷⁾
Protection class	III
Weight	18 g
Housing material	Plastic, VISTAL®
Optics material	Plastic, PMMA
Enclosure rating	IP67 IP69K
Items supplied	Mounting nut (1x), M18, plastic, black, flat
EMC	EN 60947-5-2 (The sensor complies with the Radio Safety Requirements (EMC) for the industrial sector (Radio Safety Class A). It may cause radio interference if used in a residential area.)
Ambient operating temperature	$-30 \text{ }^\circ\text{C} \dots +55 \text{ }^\circ\text{C}$ ⁸⁾
Ambient storage temperature	$-40 \text{ }^\circ\text{C} \dots +70 \text{ }^\circ\text{C}$
UL File No.	E189383

- 1) May not exceed or fall below U_V tolerances.
 2) Without signal strength light bar and load.
 3) Signal transit time with resistive load.
 4) With light/dark ratio 1:1.
 5) A = V_S connections reverse-polarity protected.
 6) B = inputs and output reverse-polarity protected.
 7) D = outputs overcurrent and short-circuit protected.
 8) Below $T_a = -10 \text{ }^\circ\text{C}$, sensor must be turned on at $T_a > -10 \text{ }^\circ\text{C}$. Sensor cannot be turned on below $T_a = -10 \text{ }^\circ\text{C}$.

Safety-related parameters

MTTF_D	282.7 years
DC_{avg}	0%

Classifications

ECl@ss 5.0	27270904
ECl@ss 5.1.4	27270904
ECl@ss 6.0	27270904
ECl@ss 6.2	27270904
ECl@ss 7.0	27270904
ECl@ss 8.0	27270904
ECl@ss 8.1	27270904
ECl@ss 9.0	27270904
ECl@ss 10.0	27270904
ECl@ss 11.0	27270904
ETIM 5.0	EC002719
ETIM 6.0	EC002719
ETIM 7.0	EC002719
UNSPSC 16.0901	39121528

Connection/Pin assignment

Connection type	Male connector M12, 4-pin
Pin assignment	
BN 1	+ (L+)
WH 2	Q ₂
BU 3	- (M)
BK 4	Q ₁

Dimensional drawing (Dimensions in mm (inch))

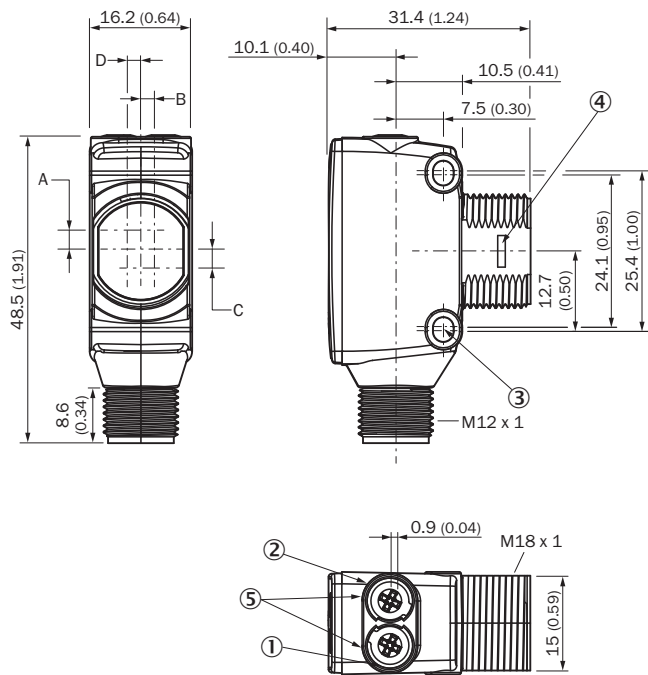

- ① LED indicator yellow: Status of received light beam
- ② LED indicator green: power on
- ③ M3 mounting hole
- ④ Snap Connection for flush ring (sold seperatly)
- ⑤ Potentiometer (if selected) or LED Indicators

Dimensions in mm (inch)	Receiver		Sender	
	A	B	C	D
HTB18 / HTF18	- 1.1 (0.04)	1.1 (0.04)	4.7 (0.19)	0.6 (0.02)
HTE18 / HL18 / HSE18	2.5 (0.1)	0.0 (0.0)	4.0 (0.16)	0.0 (0.0)
HTB18L / HTF18L / HL18L / HSE18L	2.5 (0.1)	0.0 (0.0)	3.5 (0.14)	0.0 (0.0)

Connection type

See table: **Connection/Pin assignment**

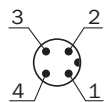

Adjustments possible



- ① LED indicator yellow: Status of received light beam
- ② LED indicator green: power on
- ③ Signal strength light bar

Characteristic curve

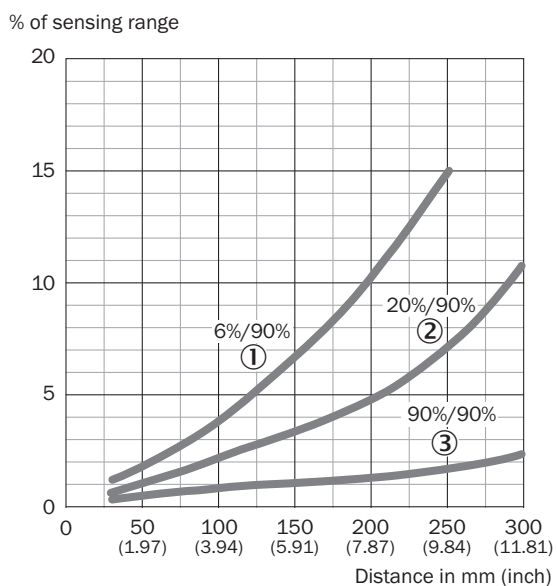

- ① Sensing range on black, 6% remission
- ② Sensing range on gray, 20% remission
- ③ Sensing range on white, 90% remission

Light spot size

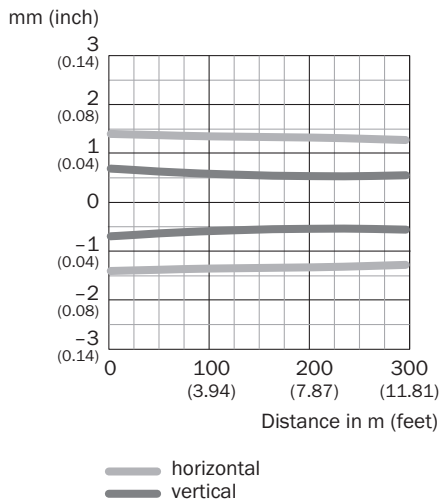

Sensing range diagram

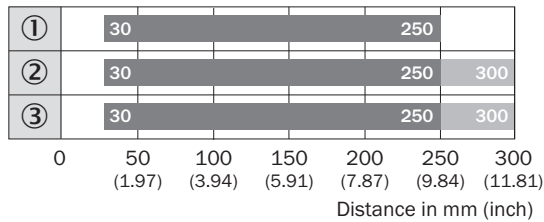

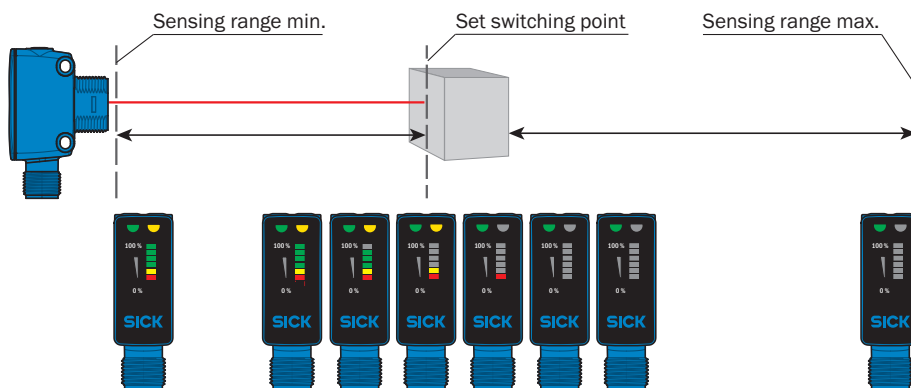

- Sensing range ■ Sensing range max.
- ① Sensing range on black, 6% remission
- ② Sensing range on gray, 20% remission
- ③ Sensing range on white, 90% remission

Functions



Recommended accessories

Other models and accessories → www.sick.com/SureSense

	Brief description	Type	Part no.
Plug connectors and cables			
	Head A: female connector, M12, 4-pin, straight, A-coded Head B: Flying leads Cable: Sensor/actuator cable, PVC, unshielded, 5 m	YF2A14-050VB3XLEAX	2096235
	Head A: male connector, M12, 4-pin, straight Head B: - Cable: unshielded	STE-1204-G	6009932

SICK AT A GLANCE

SICK is one of the leading manufacturers of intelligent sensors and sensor solutions for industrial applications. A unique range of products and services creates the perfect basis for controlling processes securely and efficiently, protecting individuals from accidents and preventing damage to the environment.

We have extensive experience in a wide range of industries and understand their processes and requirements. With intelligent sensors, we can deliver exactly what our customers need. In application centers in Europe, Asia and North America, system solutions are tested and optimized in accordance with customer specifications. All this makes us a reliable supplier and development partner.

Comprehensive services complete our offering: SICK LifeTime Services provide support throughout the machine life cycle and ensure safety and productivity.

For us, that is “Sensor Intelligence.”

WORLDWIDE PRESENCE:

Contacts and other locations –www.sick.com