



GRTB18S-P241Z

GR18S

CYLINDRICAL PHOTOELECTRIC SENSORS

SICK
Sensor Intelligence.



Ordering information

Type	Part no.
GRTB18S-P241Z	1076103

Other models and accessories → www.sick.com/GR18S

Illustration may differ



Detailed technical data

Features

Sensor/ detection principle	Photoelectric proximity sensor, Background suppression
Dimensions (W x H x D)	18 mm x 18 mm x 38.1 mm
Housing design (light emission)	Cylindrical
Thread diameter (housing)	M18 x 1
Optical axis	Axial, fully flush
Sensing range max.	3 mm ... 300 mm ¹⁾
Sensing range	20 mm ... 150 mm ¹⁾
Type of light	Visible red light
Light source	PinPoint LED ²⁾
Light spot size (distance)	Ø 7 mm (100 mm)
Wave length	650 nm
Adjustment	Potentiometer, 270°

¹⁾ Object with 90 % reflectance (referred to standard white, DIN 5033).

²⁾ Average service life: 100,000 h at T_U = +25 °C.

Mechanics/electronics

Supply voltage	10 V DC ... 30 V DC ¹⁾
Ripple	± 5 V _{pp} ²⁾

¹⁾ Limit values. Operated in short-circuit protected network: max. 8 A.

²⁾ May not exceed or fall below U_v tolerances.

³⁾ At U_v > 24 V or ambient temperature > 49 °C, I_A max. = 50 mA.

⁴⁾ Signal transit time with resistive load.

⁵⁾ With light/dark ratio 1:1.

⁶⁾ A = V_S connections reverse-polarity protected.

⁷⁾ B = inputs and output reverse-polarity protected.

⁸⁾ D = outputs overcurrent and short-circuit protected.

⁹⁾ At U_v ≤ 24V and I_A < 50mA.

Current consumption	30 mA
Switching output	PNP
Output function	Complementary
Switching mode	Light/dark switching
Signal voltage PNP HIGH/LOW	$V_S - (\leq 3 \text{ V}) / \text{approx. } 0 \text{ V}$
Output current I_{max}	100 mA ³⁾
Response time	< 500 μs ⁴⁾
Switching frequency	1,000 Hz ⁵⁾
Connection type	Male connector M12, 4-pin
Circuit protection	A ⁶⁾ B ⁷⁾ D ⁸⁾
Protection class	III
Housing material	Metal, Nickel-plated brass and ABS
Optics material	Plastic, PMMA
Enclosure rating	IP67
Items supplied	Fastening nuts (2 x)
EMC	EN 60947-5-2
Ambient operating temperature	-25 °C ... +55 °C ⁹⁾
Ambient storage temperature	-40 °C ... +70 °C
UL File No.	NRKH.E348498 & NRKH7.E348498

1) Limit values. Operated in short-circuit protected network: max. 8 A.

2) May not exceed or fall below U_V tolerances.

3) At $U_V > 24 \text{ V}$ or ambient temperature > 49 °C, $I_A \text{ max.} = 50 \text{ mA}$.

4) Signal transit time with resistive load.

5) With light/dark ratio 1:1.

6) A = V_S connections reverse-polarity protected.

7) B = inputs and output reverse-polarity protected.

8) D = outputs overcurrent and short-circuit protected.

9) At $U_V \leq 24 \text{ V}$ and $I_A < 50 \text{ mA}$.

Safety-related parameters

MTTF_D	985 years
DC_{avg}	0%

Classifications

ECI@ss 5.0	27270904
ECI@ss 5.1.4	27270904
ECI@ss 6.0	27270904
ECI@ss 6.2	27270904
ECI@ss 7.0	27270904
ECI@ss 8.0	27270904
ECI@ss 8.1	27270904
ECI@ss 9.0	27270904
ECI@ss 10.0	27270904

ECl@ss 11.0	27270904
ETIM 5.0	EC002719
ETIM 6.0	EC002719
ETIM 7.0	EC002719
UNSPSC 16.0901	39121528

Connection diagram

Cd-084

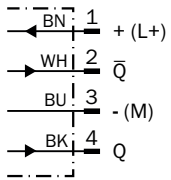

Characteristic curve

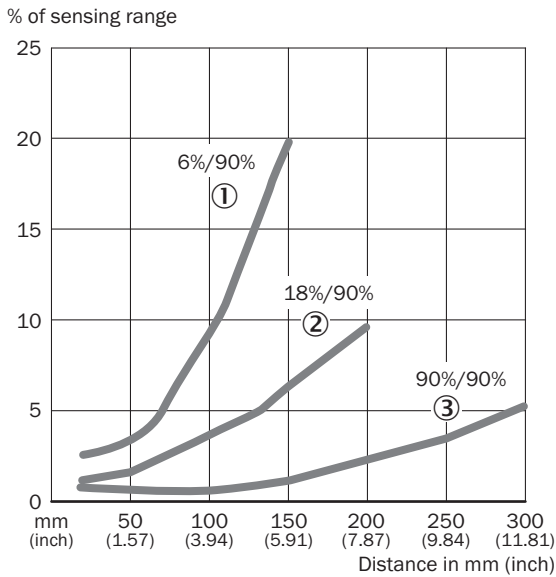

- ① Sensing range on black, 6% remission
- ② Sensing range on gray, 18% remission
- ③ Sensing range on white, 90% remission

Sensing range diagram

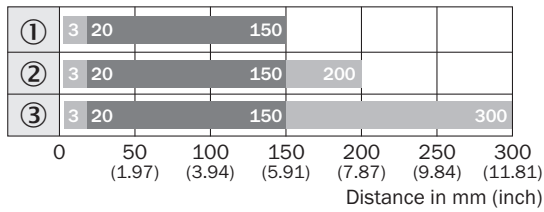

■ Sensing range ■ Sensing range max.

- ① Sensing range on black, 6% remission
- ② Sensing range on gray, 18 % remission
- ③ Sensing range on white, 90% remission

Adjustments possible

GRTB18(S), GRTE18(S), Sensing range setting: Potentiometer, 270°

Sensing range

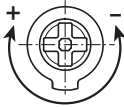

Dimensional drawing (Dimensions in mm (inch))

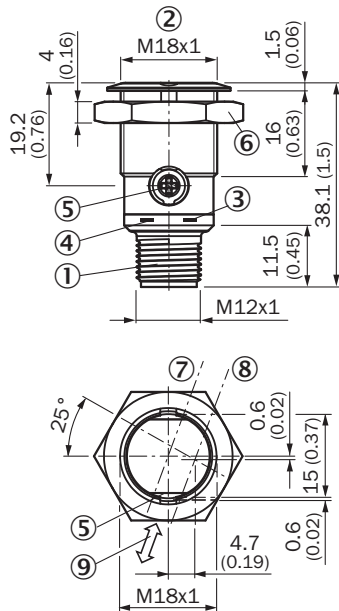

GRTB18S, metal, connector, straight, fully flush, adjustable



- ① Male connector M12, 4-pin
- ② Threaded mounting hole M18 x 1
- ③ LED indicator yellow
- ④ LED indicator green
- ⑤ Sensitivity control: potentiometer 270°
- ⑥ Fastening nut; 24 mm hex, metal
- ⑦ Optical axis, receiver
- ⑧ Optical axis, sender
- ⑨ Standard direction of the material being detected

Recommended accessories

Other models and accessories → www.sick.com/GR18S

	Brief description	Type	Part no.
Mounting brackets and plates			
	Mounting bracket for M18 sensors, steel, zinc coated, without mounting hardware	BEF-WN-M18	5308446
Other mounting accessories			
	Mounting tool for "fully flush" variants	BEF-TO-GR18S	4072132
Plug connectors and cables			
	Head A: female connector, M12, 4-pin, straight, A-coded Head B: Flying leads Cable: Sensor/actuator cable, PVC, unshielded, 5 m	YF2A14-050VB3XLEAX	2096235

	Brief description	Type	Part no.
	Head A: male connector, M12, 4-pin, straight Head B: - Cable: unshielded	STE-1204-G	6009932

SICK AT A GLANCE

SICK is one of the leading manufacturers of intelligent sensors and sensor solutions for industrial applications. A unique range of products and services creates the perfect basis for controlling processes securely and efficiently, protecting individuals from accidents and preventing damage to the environment.

We have extensive experience in a wide range of industries and understand their processes and requirements. With intelligent sensors, we can deliver exactly what our customers need. In application centers in Europe, Asia and North America, system solutions are tested and optimized in accordance with customer specifications. All this makes us a reliable supplier and development partner.

Comprehensive services complete our offering: SICK LifeTime Services provide support throughout the machine life cycle and ensure safety and productivity.

For us, that is “Sensor Intelligence.”

WORLDWIDE PRESENCE:

Contacts and other locations –www.sick.com