



WL12-3N2451

W12-3

SMALL PHOTOELECTRIC SENSORS

SICK
Sensor Intelligence.



Illustration may differ



Ordering information

Type	Part no.
WL12-3N2451	1041450

Included in delivery: BEF-KH-W12 (2)

Other models and accessories → www.sick.com/W12-3

Detailed technical data

Features

Sensor/ detection principle	Photoelectric retro-reflective sensor, autocollimation
Dimensions (W x H x D)	15.6 mm x 48.5 mm x 42 mm
Housing design (light emission)	Rectangular
Sensing range max.	0 m ... 2 m ¹⁾
Sensing range	0 m ... 1.3 m ¹⁾
Type of light	Visible red light
Light source	LED ²⁾
Light spot size (distance)	Ø 2 mm (90 mm)
Angle of dispersion	Approx. 5°
Wave length	640 nm
Adjustment	Potentiometer, 5 turns
Special applications	Detecting small objects

¹⁾ Reflector PL80A.

²⁾ Average service life: 100,000 h at T_J = +25 °C.

Mechanics/electronics

Supply voltage	10 V DC ... 30 V DC ¹⁾
Ripple	$\leq 5 V_{pp}$ ²⁾
Current consumption	40 mA ³⁾
Switching output	NPN
Output function	Complementary
Switching mode	Light/dark switching
Signal voltage NPN HIGH/LOW	Approx. $V_S / < 2.5 V$
Output current I_{max}	100 mA
Response time	$\leq 330 \mu s$ ⁴⁾
Switching frequency	1,500 Hz ⁵⁾
Connection type	Male connector M12, 4-pin
Circuit protection	A ⁶⁾ C ⁷⁾ D ⁸⁾
Protection class	III
Weight	120 g
Polarisation filter	✓
Housing material	Metal
Optics material	Plastic, PMMA
Enclosure rating	IP66 IP67 IP69K
Items supplied	2 x clamps BEF-KH-W12, incl. screws
Special feature	Focused optics
Ambient operating temperature	-40 °C ... +60 °C
Ambient storage temperature	-40 °C ... +75 °C
UL File No.	NRKH.E181493 & NRKH7.E181493

¹⁾ Limit values when operated in short-circuit protected network: max. 8 A.

²⁾ May not exceed or fall below U_V tolerances.

³⁾ Without load.

⁴⁾ Signal transit time with resistive load.

⁵⁾ With light/dark ratio 1:1.

⁶⁾ A = V_S connections reverse-polarity protected.

⁷⁾ C = interference suppression.

⁸⁾ D = outputs overcurrent and short-circuit protected.

Safety-related parameters

MTTF_D	1,388 years
DC_{avg}	0%

Classifications

ECl@ss 5.0	27270902
ECl@ss 5.1.4	27270902
ECl@ss 6.0	27270902

ECl@ss 6.2	27270902
ECl@ss 7.0	27270902
ECl@ss 8.0	27270902
ECl@ss 8.1	27270902
ECl@ss 9.0	27270902
ECl@ss 10.0	27270902
ECl@ss 11.0	27270902
ETIM 5.0	EC002717
ETIM 6.0	EC002717
ETIM 7.0	EC002717
UNSPSC 16.0901	39121528

Connection diagram

Cd-083

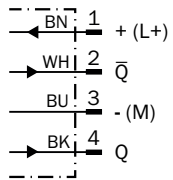

Characteristic curve

WL12-3, focused

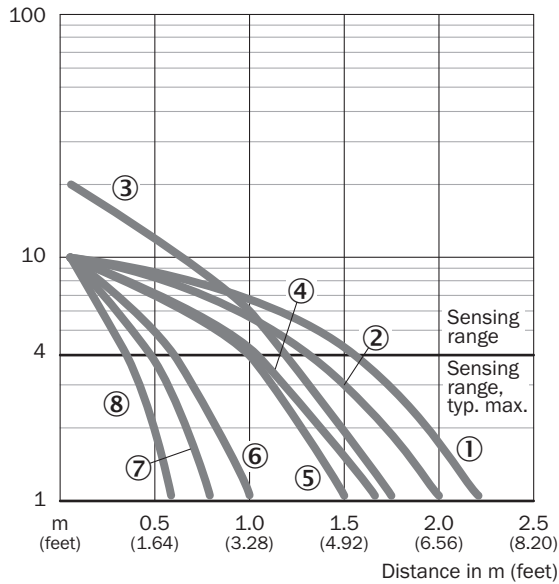

- ① Reflector C110A
- ② Reflector PL80A
- ③ Reflector P250
- ④ Reflector PL50A
- ⑤ Reflector PL40A
- ⑥ Reflector PL30A
- ⑦ Reflector PL20A
- ⑧ Reflector DG/IRF6000

Sensing range diagram

WL12-3, focused

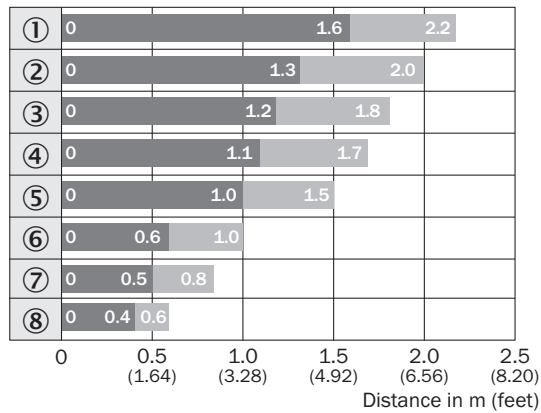

■ Sensing range ■ Sensing range typ. max.

- ① Reflector C110A
- ② Reflector PL80A
- ③ Reflector P250F
- ④ Reflector PL50A
- ⑤ Reflector PL40A
- ⑥ Reflector PL30A
- ⑦ Reflector PL20A
- ⑧ Reflective tape Diamond Grade

Adjustments possible

WL12-3, WSE12-3

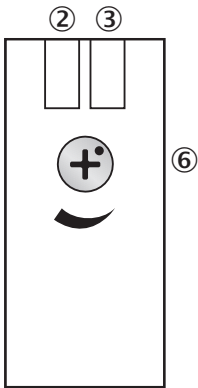

- ② LED indicator yellow: Status of received light beam
- ③ LED indicator green: Supply voltage active
- ⑥ Sensitivity control: potentiometer

Dimensional drawing (Dimensions in mm (inch))



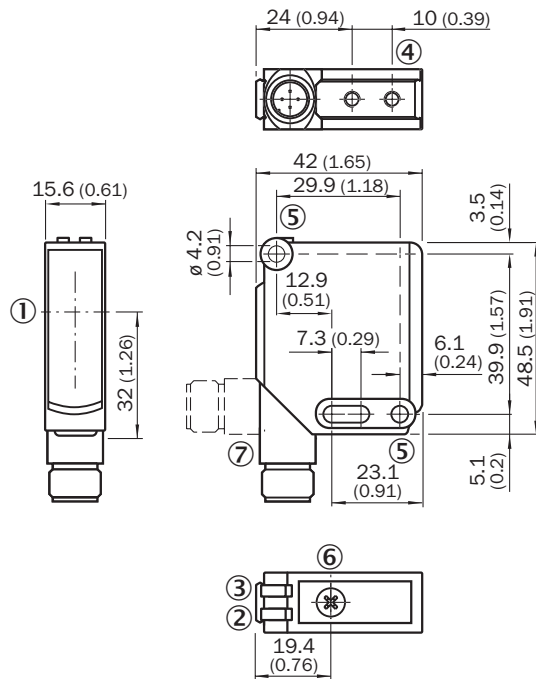

WL12-3, WSE12-3



- ① Optical axis
- ② LED indicator yellow: Status of received light beam
- ③ LED indicator green: Supply voltage active
- ④ M4 threaded mounting hole, 4 mm deep
- ⑤ Mounting hole, \varnothing 4.2 mm
- ⑥ Sensitivity control: potentiometer
- ⑦ Connection

Recommended accessories

Other models and accessories → www.sick.com/W12-3

	Brief description	Type	Part no.
Mounting brackets and plates			
	Universal mounting bracket for reflectors, steel, zinc coated	BEF-WN-REFX	2064574
Plug connectors and cables			
	Head A: female connector, M12, 4-pin, straight, A-coded Head B: Flying leads Cable: Sensor/actuator cable, PVC, unshielded, 5 m	YF2A14-050VB3XLEAX	2096235
	Head A: male connector, M12, 4-pin, straight Head B: - Cable: unshielded	STE-1204-G	6009932
Reflectors			
	Rectangular, screw connection, 38 mm x 15 mm, PMMA/ABS, Screw-on, 2 hole mounting	PL20A	1012719

SICK AT A GLANCE

SICK is one of the leading manufacturers of intelligent sensors and sensor solutions for industrial applications. A unique range of products and services creates the perfect basis for controlling processes securely and efficiently, protecting individuals from accidents and preventing damage to the environment.

We have extensive experience in a wide range of industries and understand their processes and requirements. With intelligent sensors, we can deliver exactly what our customers need. In application centers in Europe, Asia and North America, system solutions are tested and optimized in accordance with customer specifications. All this makes us a reliable supplier and development partner.

Comprehensive services complete our offering: SICK LifeTime Services provide support throughout the machine life cycle and ensure safety and productivity.

For us, that is “Sensor Intelligence.”

WORLDWIDE PRESENCE:

Contacts and other locations –www.sick.com