



# VL180-2P42433

V180-2

CYLINDRICAL PHOTOELECTRIC SENSORS

**SICK**  
Sensor Intelligence.



## Ordering information

Type	Part no.
VL180-2P42433	6043834

Included in delivery: P250 (1)

Other models and accessories → [www.sick.com/V180-2](http://www.sick.com/V180-2)

Illustration may differ



## Detailed technical data

### Features

<b>Sensor/ detection principle</b>	Photoelectric retro-reflective sensor, Dual lens
<b>Dimensions (W x H x D)</b>	18 mm x 18 mm x 84.2 mm
<b>Housing design (light emission)</b>	Cylindrical
<b>Housing length</b>	84.2 mm
<b>Optical axis</b>	Radial
<b>Sensing range max.</b>	0.05 m ... 5.5 m <sup>1)</sup>
<b>Sensing range</b>	0.05 m ... 4.5 m <sup>1)</sup>
<b>Type of light</b>	Visible red light
<b>Light source</b>	LED <sup>2)</sup>
<b>Light spot size (distance)</b>	Ø 270 mm (4 m)
<b>Angle of dispersion</b>	Approx. 4.5°
<b>Wave length</b>	645 nm
<b>Adjustment</b>	Potentiometer, 270° (Sensitivity)

<sup>1)</sup> Reflector PL80A.

<sup>2)</sup> Average service life: 100,000 h at T<sub>J</sub> = +25 °C.

### Mechanics/electronics

<b>Supply voltage</b>	10 V DC ... 30 V DC <sup>1)</sup>
<b>Ripple</b>	± 10 % <sup>2)</sup>
<b>Power consumption</b>	30 mA <sup>3)</sup>

<sup>1)</sup> Limit values when operated in short-circuit protected network: max. 8 A.

<sup>2)</sup> May not exceed or fall below U<sub>V</sub> tolerances.

<sup>3)</sup> Without load.

<sup>4)</sup> Control wire open: dark switching D.ON.

<sup>5)</sup> Signal transit time with resistive load.

<sup>6)</sup> With light/dark ratio 1:1.

<sup>7)</sup> A = V<sub>S</sub> connections reverse-polarity protected.

<sup>8)</sup> B = inputs and output reverse-polarity protected.

<sup>9)</sup> D = outputs overcurrent and short-circuit protected.

<b>Switching output</b>	PNP <sup>4)</sup>
<b>Switching mode</b>	Light/dark switching <sup>4)</sup>
<b>Signal voltage PNP HIGH/LOW</b>	Approx. $V_S - 1.8 \text{ V} / 0 \text{ V}$
<b>Output current <math>I_{\text{max}}</math></b>	$\leq 100 \text{ mA}$
<b>Response time</b>	$\leq 0.5 \text{ ms}$ <sup>5)</sup>
<b>Switching frequency</b>	1,000 Hz <sup>6)</sup>
<b>Connection type</b>	Male connector M12, 4-pin
<b>Circuit protection</b>	A <sup>7)</sup> B <sup>8)</sup> D <sup>9)</sup>
<b>Protection class</b>	III
<b>Weight</b>	47 g
<b>Polarisation filter</b>	✓
<b>Housing material</b>	Metal, Nickel-plated brass and PC
<b>Optics material</b>	Plastic, PMMA
<b>Enclosure rating</b>	IP67
<b>Items supplied</b>	Reflector P250
<b>Ambient operating temperature</b>	-25 °C ... +55 °C
<b>Ambient storage temperature</b>	-40 °C ... +70 °C

1) Limit values when operated in short-circuit protected network: max. 8 A.

2) May not exceed or fall below  $U_V$  tolerances.

3) Without load.

4) Control wire open: dark switching D.ON.

5) Signal transit time with resistive load.

6) With light/dark ratio 1:1.

7) A =  $V_S$  connections reverse-polarity protected.

8) B = inputs and output reverse-polarity protected.

9) D = outputs overcurrent and short-circuit protected.

## Safety-related parameters

<b>MTTF<sub>D</sub></b>	2,006 years
<b>DC<sub>avg</sub></b>	0%

## Classifications

<b>ECl@ss 5.0</b>	27270902
<b>ECl@ss 5.1.4</b>	27270902
<b>ECl@ss 6.0</b>	27270902
<b>ECl@ss 6.2</b>	27270902
<b>ECl@ss 7.0</b>	27270902
<b>ECl@ss 8.0</b>	27270902
<b>ECl@ss 8.1</b>	27270902
<b>ECl@ss 9.0</b>	27270902
<b>ECl@ss 10.0</b>	27270902
<b>ECl@ss 11.0</b>	27270902
<b>ETIM 5.0</b>	EC002717

# VL180-2P42433 | V180-2

## CYLINDRICAL PHOTOELECTRIC SENSORS

<b>ETIM 6.0</b>	EC002717
<b>ETIM 7.0</b>	EC002717
<b>UNSPSC 16.0901</b>	39121528

### Connection diagram

Cd-087

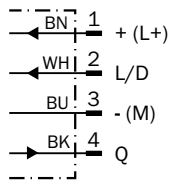

### Characteristic curve

VL180-2, 5.5 m, radial

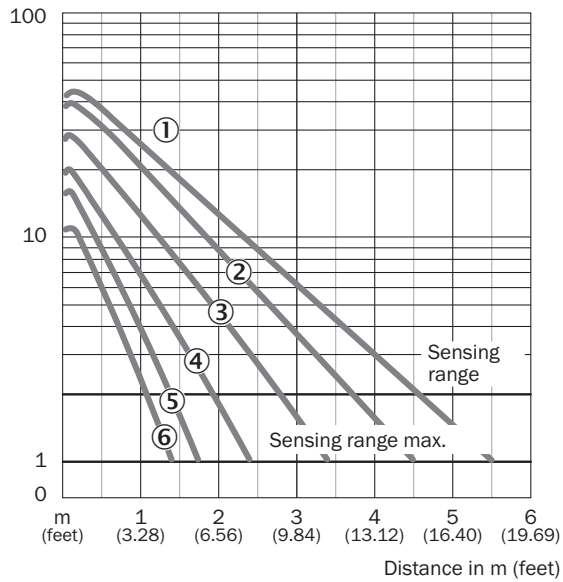

- ① Reflector PL80A
- ② Reflector P250, PL40A, PL50A, C110A
- ③ Reflector PL30A, PL31A
- ④ Reflector PL20A
- ⑤ P45
- ⑥ Reflective tape Diamond Grade

## Light spot size

VL180-2

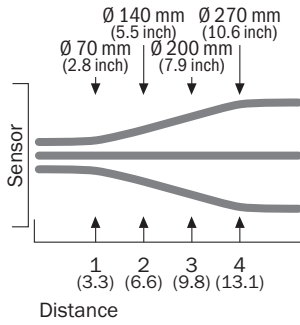

## Sensing range diagram

VL180-2, 5.5 m, radial

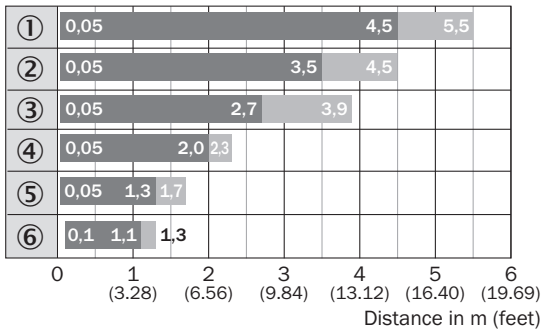

■ Sensing range      ■ Sensing range max.

- ① Reflector PL80A
- ② Reflector P250, PL40A, PL50A, C110A
- ③ Reflector PL30A, PL31A
- ④ Reflector PL20A
- ⑤ P45
- ⑥ Reflective tape Diamond Grade

Adjustments possible

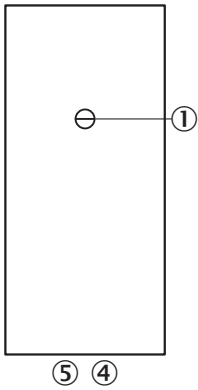

- ③ Sensitivity control 270°
- ④ LED indicator orange: switching output active
- ⑤ LED indicator green

Dimensional drawing (Dimensions in mm (inch))

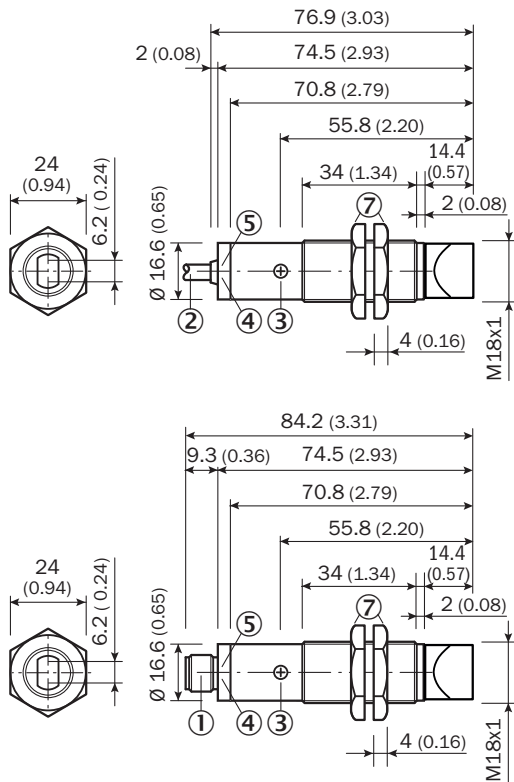

VL180-2, metal, radial



- ① Connector M12, 3-pin / Connector M12, 3-pin
- ② Connection cable 2 m
- ③ Sensitivity control: potentiometer 270°
- ④ LED indicator orange: switching output active
- ⑤ LED indicator green, stability indicator: LED lights continuously = light reception < 0.9/> 1.1; LED off = light reception > 0.9 / < 1.1
- ⑦ Metal housing, fastening nuts (2 x); width across 24

**Recommended accessories**

Other models and accessories → [www.sick.com/V180-2](http://www.sick.com/V180-2)

	<b>Brief description</b>	<b>Type</b>	<b>Part no.</b>
<b>Plug connectors and cables</b>			
	Head A: female connector, M12, 4-pin, straight, A-coded Head B: Flying leads Cable: Sensor/actuator cable, PVC, unshielded, 5 m	YF2A14-050VB3XLEAX	2096235
	Head A: male connector, M12, 4-pin, straight Head B: - Cable: unshielded	STE-1204-G	6009932
<b>Reflectors</b>			
	Rectangular, screw connection, 47 mm x 47 mm, PMMA/ABS, Screw-on, 2 hole mounting	P250	5304812

## SICK AT A GLANCE

SICK is one of the leading manufacturers of intelligent sensors and sensor solutions for industrial applications. A unique range of products and services creates the perfect basis for controlling processes securely and efficiently, protecting individuals from accidents and preventing damage to the environment.

We have extensive experience in a wide range of industries and understand their processes and requirements. With intelligent sensors, we can deliver exactly what our customers need. In application centers in Europe, Asia and North America, system solutions are tested and optimized in accordance with customer specifications. All this makes us a reliable supplier and development partner.

Comprehensive services complete our offering: SICK LifeTime Services provide support throughout the machine life cycle and ensure safety and productivity.

For us, that is “Sensor Intelligence.”

## WORLDWIDE PRESENCE:

Contacts and other locations –[www.sick.com](http://www.sick.com)