



WL24-2X430

W24-2 Ex

COMPACT PHOTOELECTRIC SENSORS

SICK
Sensor Intelligence.



Illustration may differ



Ordering information

Type	Part no.
WL24-2X430	1026037

Other models and accessories → www.sick.com/W24-2_Ex

Detailed technical data

Features

Sensor/ detection principle	Photoelectric retro-reflective sensor
Dimensions (W x H x D)	27 mm x 87.5 mm x 65 mm
Housing design (light emission)	Rectangular
Sensing range max.	0 m ... 22 m ¹⁾
Sensing range	0 m ... 15 m ¹⁾
Type of light	Visible red light
Light source	LED ²⁾
Light spot size (distance)	Ø 250 mm (15 m)
Adjustment	Potentiometer
Special applications	Explosive areas

¹⁾ Reflector PL80A.

²⁾ Average service life: 100,000 h at T_J = +25 °C.

Mechanics/electronics

Supply voltage	5 V DC ... 15.5 V DC ¹⁾
Ripple	< 0.4 V _{pp} ²⁾
Switching output	NAMUR
Switching mode	Light switching
Response time	≤ 10 ms ³⁾

¹⁾ Limit values, supply with switching amplifier EN2Ex (internal resistor approx. 1 kOhm).

²⁾ May not exceed or fall below U_v tolerances.

³⁾ Signal transit time with resistive load.

⁴⁾ With light/dark ratio 1:1.

⁵⁾ A = V_S connections reverse-polarity protected.

⁶⁾ C = interference suppression.

⁷⁾ Reference voltage: 50 V DC.

⁸⁾ For connection to a separately certified intrinsically safe circuit only.

Switching frequency	50 Hz ⁴⁾
Connection type	Male connector M12, 4-pin
Circuit protection	A ⁵⁾ C ⁶⁾
Protection class	II ⁷⁾
Weight	330 g
Polarisation filter	✓
Housing material	Metal, Zinc diecast
Optics material	Glass, glass
Enclosure rating	IP67
EC Approval Certificate	PTB 08 ATEX 2029
Certificate (IECEX)	IECEX PTB 14.0031
ATEX marking	Ex II 2G Ex ia op is IIC T4 Gb according to directive 2014/34/EU
Ex area category	2G
Input voltage U_i max.	≤ 15.5 V ⁸⁾
Input power P_i max.	≤ 100 mW ⁸⁾
Input current I_i max.	≤ 53 mA ⁸⁾
Internal capacitance C_i max.	80 nF ⁸⁾
Internal inductance L_i max.	0 μH ⁸⁾
Ambient operating temperature	-20 °C ... +60 °C
Ambient storage temperature	-25 °C ... +70 °C
UL File No.	Ex II 2G EEx ia op is IIC T4, ATEX Nr. PTB08 ATEX 2029

- 1) Limit values, supply with switching amplifier EN2Ex (internal resistor approx. 1 kOhm).
 2) May not exceed or fall below U_v tolerances.
 3) Signal transit time with resistive load.
 4) With light/dark ratio 1:1.
 5) A = V_S connections reverse-polarity protected.
 6) C = interference suppression.
 7) Reference voltage: 50 V DC.
 8) For connection to a separately certified intrinsically safe circuit only.

Safety-related parameters

MTTF_D	258 years
DC_{avg}	0%

Classifications

ECl@ss 5.0	27270902
ECl@ss 5.1.4	27270902
ECl@ss 6.0	27270902
ECl@ss 6.2	27270902
ECl@ss 7.0	27270902
ECl@ss 8.0	27270902
ECl@ss 8.1	27270902
ECl@ss 9.0	27270902

ECl@ss 10.0	27270902
ECl@ss 11.0	27270902
ETIM 5.0	EC002717
ETIM 6.0	EC002717
ETIM 7.0	EC002717
UNSPSC 16.0901	39121528

Connection diagram

Cd-122

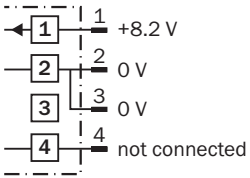

Characteristic curve

WL24-2

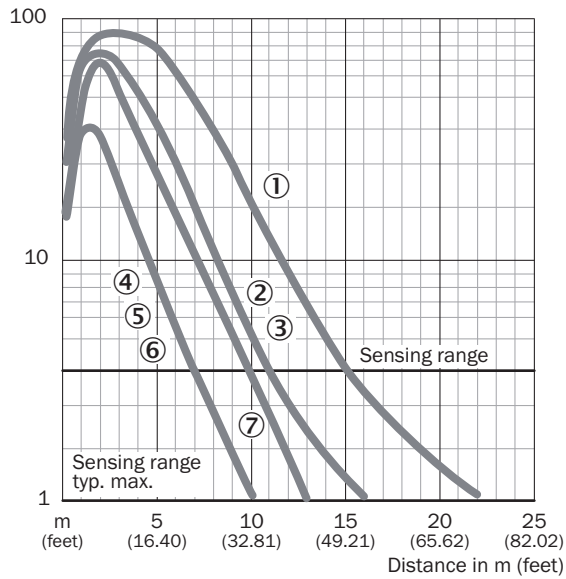

- ① Reflector PL80A
- ② Reflector PL50A
- ③ Reflector PL40A
- ④ Reflector PL30A
- ⑤ Reflector PL20A
- ⑥ Reflective tape Diamond Grade
- ⑦ Reflector C110A

Sensing range diagram

WL24-2

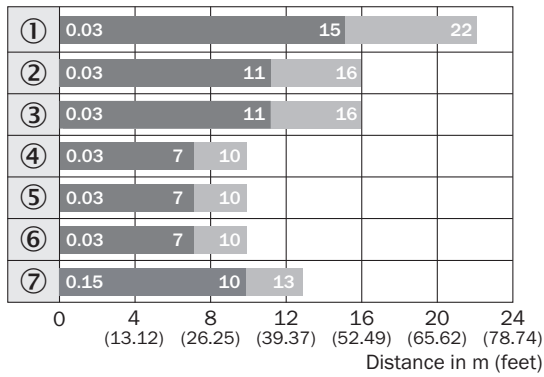

■ Sensing range ■ Sensing range max.

- ① Reflector PL80A
- ② Reflector PL50A
- ③ Reflector PL40A
- ④ Reflector PL30A
- ⑤ Reflector PL20A
- ⑥ Reflective tape Diamond Grade
- ⑦ Reflector C110A

Adjustments possible

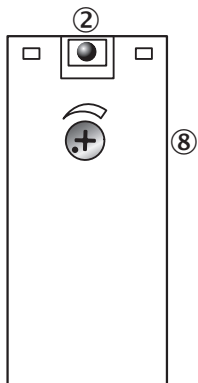

- ② LED signal strength indicator
- ⑧ Sensitivity control

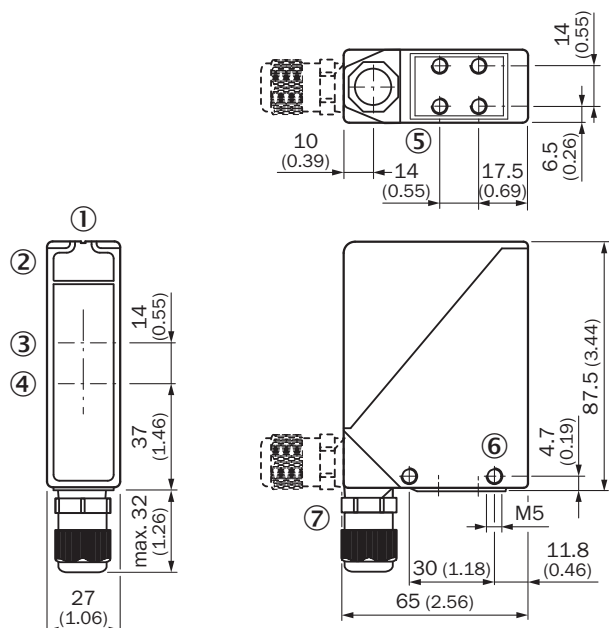

Dimensional drawing (Dimensions in mm (inch))



- ① Alignment sight
- ② LED signal strength indicator
- ③ Center of optical axis, sender
- ④ Center of optical axis, receiver
- ⑤ M5 threaded mounting hole, 6 mm deep
- ⑥ M5 threaded mounting hole, through-hole
- ⑦ M16 screw fixing rotatable by 90°

Recommended accessories

Other models and accessories → www.sick.com/W24-2_Ex

	Brief description	Type	Part no.
Mounting brackets and plates			
	Mounting bracket, large, stainless steel, without mounting hardware for the sensor	BEF-WG-W24	4026324
	Universal mounting bracket for reflectors, steel, zinc coated	BEF-WN-REFX	2064574
Reflectors			
	Rectangular, screw connection, 80 mm x 80 mm, PMMA/ABS, Screw-on, 2 hole mounting	PL80A	1003865

SICK AT A GLANCE

SICK is one of the leading manufacturers of intelligent sensors and sensor solutions for industrial applications. A unique range of products and services creates the perfect basis for controlling processes securely and efficiently, protecting individuals from accidents and preventing damage to the environment.

We have extensive experience in a wide range of industries and understand their processes and requirements. With intelligent sensors, we can deliver exactly what our customers need. In application centers in Europe, Asia and North America, system solutions are tested and optimized in accordance with customer specifications. All this makes us a reliable supplier and development partner.

Comprehensive services complete our offering: SICK LifeTime Services provide support throughout the machine life cycle and ensure safety and productivity.

For us, that is “Sensor Intelligence.”

WORLDWIDE PRESENCE:

Contacts and other locations –www.sick.com