



**WLG4S-3P3232**

W4S-3 Glass

**MINIATURE PHOTOELECTRIC SENSORS**

**SICK**  
Sensor Intelligence.



Illustration may differ



### Ordering information

| Type         | Part no. |
|--------------|----------|
| WLG4S-3P3232 | 1052963  |

Other models and accessories → [www.sick.com/W4S-3\\_Glass](http://www.sick.com/W4S-3_Glass)

### Detailed technical data

#### Features

|  |  |
|--|--|
| <b>Sensor/ detection principle</b>     | Photoelectric retro-reflective sensor, autocollimation |
| <b>Dimensions (W x H x D)</b>          | 12.2 mm x 41.8 mm x 17.3 mm                            |
| <b>Housing design (light emission)</b> | Rectangular  |
| <b>Sensing range max.</b>              | 0.01 m ... 5 m <sup>1)</sup>                           |
| <b>Sensing range</b>                   | 0 m ... 3 m <sup>1)</sup>                              |
| <b>Type of light</b>                   | Visible red light                                      |
| <b>Light source</b>                    | PinPoint LED <sup>2)</sup>                             |
| <b>Light spot size (distance)</b>      | Ø 45 mm (1.5 m)  |
| <b>Wave length</b>                     | 650 nm   |
| <b>Adjustment</b>                      | Single teach-in button                                 |
| <b>AutoAdapt</b>                       | ✓  |
| <b>Special applications</b>            | Detecting transparent objects                          |

<sup>1)</sup> Reflector PL80A.

<sup>2)</sup> Average service life: 100,000 h at T<sub>J</sub> = +25 °C.

Mechanics/electronics

|                                       |   |
|---------------------------------------|---|
| <b>Supply voltage</b>                 | 10 V DC ... 30 V DC <sup>1)</sup>                         |
| <b>Ripple</b>                         | < 5 V <sub>pp</sub> <sup>2)</sup>                         |
| <b>Power consumption</b>              | 20 mA <sup>3)</sup>                                       |
| <b>Switching output</b>               | PNP   |
| <b>Switching mode</b>                 | Light/dark switching                                      |
| <b>Output current I<sub>max</sub></b> | ≤ 100 mA  |
| <b>Response time</b>                  | < 0.5 ms <sup>4)</sup>                                    |
| <b>Switching frequency</b>            | 1,000 Hz <sup>5)</sup>                                    |
| <b>Angle of reception</b>             | 30°   |
| <b>Attenuation along light beam</b>   | > 8 %   |
| <b>Connection type</b>                | Cable with M8 male connector, 4-pin, 100 mm <sup>6)</sup> |
| <b>Cable material</b>                 | PVC   |
| <b>Circuit protection</b>             | A <sup>7)</sup><br>C <sup>8)</sup><br>D <sup>9)</sup>     |
| <b>Protection class</b>               | III   |
| <b>Weight</b>                         | 30 g  |
| <b>Polarisation filter</b>            | ✓   |
| <b>Housing material</b>               | Plastic, ABS  |
| <b>Optics material</b>                | Plastic, PMMA   |
| <b>Enclosure rating</b>               | IP67<br>IP66  |
| <b>Special feature</b>                | Detecting transparent objects                             |
| <b>Ambient operating temperature</b>  | -40 °C ... +60 °C   |
| <b>Ambient storage temperature</b>    | -40 °C ... +75 °C   |
| <b>UL File No.</b>                    | NRKH.E181493 & NRKH7.E181493                              |

<sup>1)</sup> Limit values.

<sup>2)</sup> May not exceed or fall below U<sub>v</sub> tolerances.

<sup>3)</sup> Without load.

<sup>4)</sup> Signal transit time with resistive load.

<sup>5)</sup> With light/dark ratio 1:1.

<sup>6)</sup> Do not bend below 0 °C.

<sup>7)</sup> A = V<sub>S</sub> connections reverse-polarity protected.

<sup>8)</sup> C = interference suppression.

<sup>9)</sup> D = outputs overcurrent and short-circuit protected.

Classifications

|                     |          |
|---------------------|----------|
| <b>ECl@ss 5.0</b>   | 27270902 |
| <b>ECl@ss 5.1.4</b> | 27270902 |
| <b>ECl@ss 6.0</b>   | 27270902 |
| <b>ECl@ss 6.2</b>   | 27270902 |
| <b>ECl@ss 7.0</b>   | 27270902 |
| <b>ECl@ss 8.0</b>   | 27270902 |

|                       |          |
|-----------------------|----------|
| <b>ECl@ss 8.1</b>     | 27270902 |
| <b>ECl@ss 9.0</b>     | 27270902 |
| <b>ECl@ss 10.0</b>    | 27270902 |
| <b>ECl@ss 11.0</b>    | 27270902 |
| <b>ETIM 5.0</b>       | EC002717 |
| <b>ETIM 6.0</b>       | EC002717 |
| <b>ETIM 7.0</b>       | EC002717 |
| <b>UNSPSC 16.0901</b> | 39121528 |

### Connection diagram

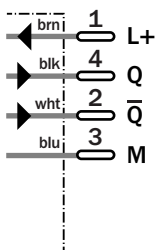

### Characteristic curve

WL4S-3, WLG4S-3, 5 m

Operating reserve

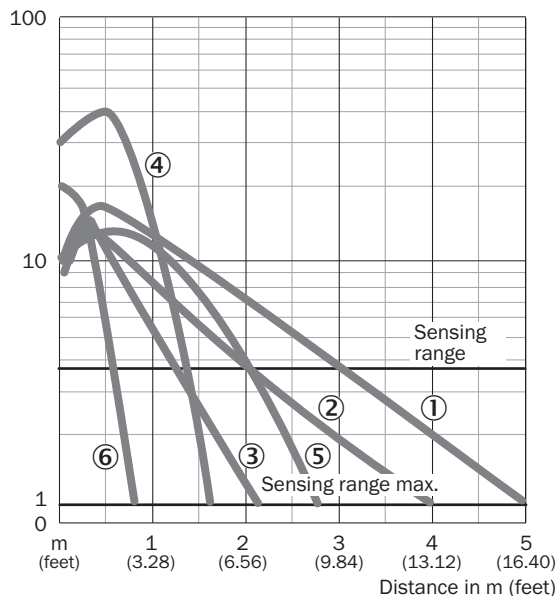

- ① Reflector PL80A
- ② Reflector PL40A
- ③ Reflector PL20A
- ④ PL10F reflector
- ⑤ Reflector P250 CHEM
- ⑥ Reflective tape REF-IRF-56

### Light spot size

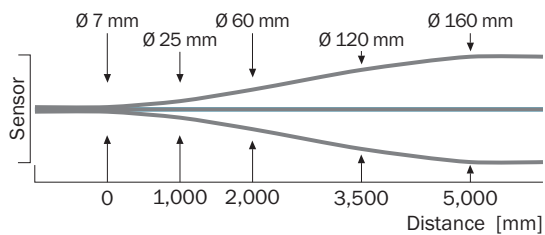

### Sensing range diagram

WL4S-3, WLG4S-3, 5 m

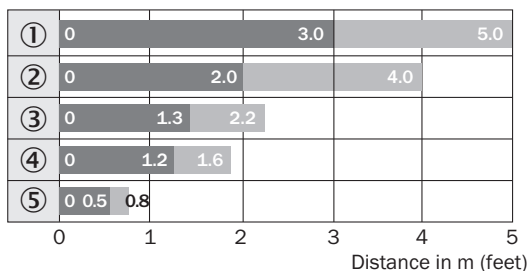

■ Sensing range      ■ Sensing range max.

- ① Reflector PL80A
- ② Reflector PL40A
- ③ Reflector PL20A
- ④ PL10F reflector
- ⑤ Reflective tape REF-IRF-56

**Dimensional drawing** (Dimensions in mm (inch))



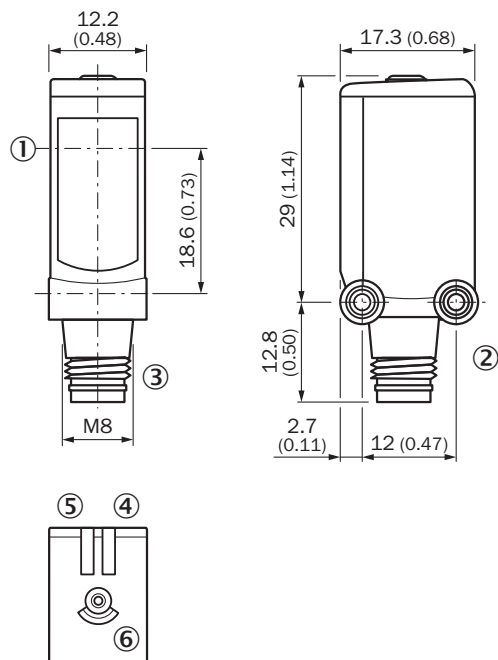

WL4S-3, WLG4S-3, single teach-in button



- ① Center of optical axis
- ② Threaded mounting hole M3
- ③ Connection
- ④ LED indicator green: Supply voltage active
- ⑤ Orange LED indicator: status of received light beam
- ⑥ Teach-in button

**Recommended accessories**

Other models and accessories → [www.sick.com/W4S-3\\_Glass](http://www.sick.com/W4S-3_Glass)

|   | <b>Brief description</b>   | <b>Type</b>        | <b>Part no.</b> |
|---|--|--------------------|-----------------|
| <b>Mounting brackets and plates</b>   |  |                    |                 |
|  | Mounting bracket for wall mounting, Stainless steel 1.4571, mounting hardware included   | BEF-W4-A           | 2051628         |
|  | Universal mounting bracket for reflectors, steel, zinc coated  | BEF-WN-REFX        | 2064574         |
| <b>Plug connectors and cables</b>   |  |                    |                 |
|  | Head A: female connector, M8, 4-pin, straight, A-coded<br>Head B: Flying leads<br>Cable: Sensor/actuator cable, PVC, unshielded, 5 m | YF8U14-050VA3XLEAX | 2095889         |
|  | Head A: male connector, M8, 4-pin, straight<br>Head B: -<br>Cable: unshielded  | STE-0804-G         | 6037323         |

|   | <b>Brief description</b>   | <b>Type</b> | <b>Part no.</b> |
|---|--|-------------|-----------------|
| Reflectors  |  |             |                 |
|  | Fine triple reflector, screw connection, suitable for laser sensors, 18 mm x 18 mm, PM-MA/ABS, Screw-on, 2 hole mounting | PL10F       | 5311210         |

## SICK AT A GLANCE

SICK is one of the leading manufacturers of intelligent sensors and sensor solutions for industrial applications. A unique range of products and services creates the perfect basis for controlling processes securely and efficiently, protecting individuals from accidents and preventing damage to the environment.

We have extensive experience in a wide range of industries and understand their processes and requirements. With intelligent sensors, we can deliver exactly what our customers need. In application centers in Europe, Asia and North America, system solutions are tested and optimized in accordance with customer specifications. All this makes us a reliable supplier and development partner.

Comprehensive services complete our offering: SICK LifeTime Services provide support throughout the machine life cycle and ensure safety and productivity.

For us, that is “Sensor Intelligence.”

## WORLDWIDE PRESENCE:

Contacts and other locations –[www.sick.com](http://www.sick.com)