



# WL4S-3E2132V

W4S-3 Inox

MINIATURE PHOTOELECTRIC SENSORS

**SICK**  
Sensor Intelligence.



Illustration may differ



### Ordering information

Type	Part no.
WL4S-3E2132V	1046435

Other models and accessories → [www.sick.com/W4S-3\\_Inox](http://www.sick.com/W4S-3_Inox)

### Detailed technical data

#### Features

<b>Sensor/ detection principle</b>	Photoelectric retro-reflective sensor, autocollimation
<b>Dimensions (W x H x D)</b>	15.25 mm x 44.9 mm x 22.2 mm
<b>Housing design</b>	Washdown
<b>Housing design (light emission)</b>	Rectangular
<b>Sensing range max.</b>	0 m ... 5 m <sup>1)</sup>
<b>Sensing range</b>	0 m ... 3 m <sup>1)</sup>
<b>Type of light</b>	Visible red light
<b>Light source</b>	PinPoint LED <sup>2)</sup>
<b>Light spot size (distance)</b>	Ø 45 mm (1.5 m)
<b>Wave length</b>	650 nm
<b>Adjustment</b>	Single teach-in button
<b>Special applications</b>	Hygienic and washdown zones

<sup>1)</sup> Reflector PL80A.

<sup>2)</sup> Average service life: 100,000 h at T<sub>U</sub> = +25 °C.

## Mechanics/electronics

<b>Supply voltage</b>	10 V DC ... 30 V DC <sup>1)</sup>
<b>Ripple</b>	< 5 V <sub>pp</sub> <sup>2)</sup>
<b>Current consumption</b>	30 mA <sup>3)</sup>
<b>Switching output</b>	NPN
<b>Switching mode</b>	Dark switching
<b>Output current I<sub>max.</sub></b>	≤ 100 mA
<b>Response time</b>	< 0.5 ms <sup>4)</sup>
<b>Switching frequency</b>	1,000 Hz <sup>5)</sup>
<b>Connection type</b>	Connector M8, 3-pin <sup>6)</sup>
<b>Circuit protection</b>	A, B, C <sup>7) 8) 9)</sup>
<b>Protection class</b>	III
<b>Weight</b>	40 g
<b>Polarisation filter</b>	✓
<b>Housing material</b>	Stainless steel, Stainless steel
<b>Enclosure rating</b>	IP66, IP67, IP68, IP69K <sup>10)</sup>
<b>Ambient operating temperature</b>	-30 °C ... +70 °C <sup>11)</sup> -30 °C ... +60 °C
<b>Ambient storage temperature</b>	-30 °C ... +75 °C
<b>UL File No.</b>	NRKH.E181493 & NRKH7.E181493

<sup>1)</sup> Limit values, reverse-polarity protected, operation in short-circuit protected network: max. 8 A.

<sup>2)</sup> May not exceed or fall below U<sub>v</sub> tolerances.

<sup>3)</sup> Without load.

<sup>4)</sup> Signal transit time with resistive load.

<sup>5)</sup> With light/dark ratio 1:1.

<sup>6)</sup> Max. tightening torque: 0.6 Nm.

<sup>7)</sup> A = V<sub>S</sub> connections reverse-polarity protected.

<sup>8)</sup> B = inputs and output reverse-polarity protected.

<sup>9)</sup> C = interference suppression.

<sup>10)</sup> Only in case of correctly mounted IP69K connecting cable.

<sup>11)</sup> At UV ≤ 24 V and IA < 30 mA.

## Classifications

<b>ECl@ss 5.0</b>	27270902
<b>ECl@ss 5.1.4</b>	27270902
<b>ECl@ss 6.0</b>	27270902
<b>ECl@ss 6.2</b>	27270902
<b>ECl@ss 7.0</b>	27270902
<b>ECl@ss 8.0</b>	27270902
<b>ECl@ss 8.1</b>	27270902
<b>ECl@ss 9.0</b>	27270902
<b>ECl@ss 10.0</b>	27270902
<b>ECl@ss 11.0</b>	27270902
<b>ETIM 5.0</b>	EC002717

<b>ETIM 6.0</b>	EC002717
<b>ETIM 7.0</b>	EC002717
<b>UNSPSC 16.0901</b>	39121528

### Connection diagram

Cd-045

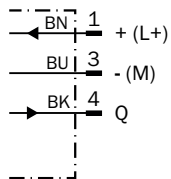

### Characteristic curve

WL4S-3, WLG4S-3, 5 m

Operating reserve

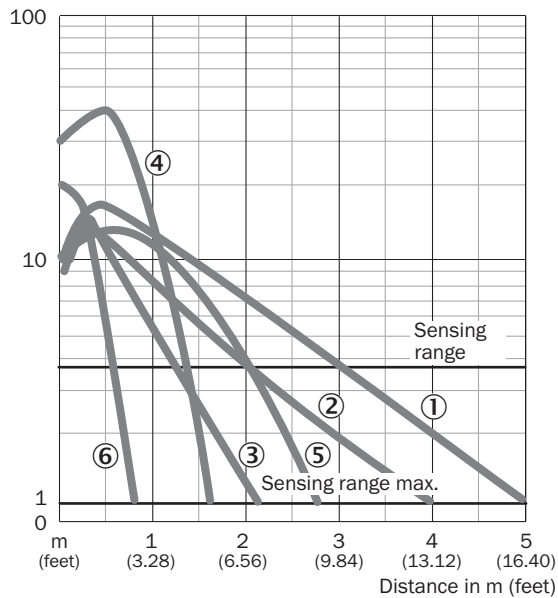

- ① Reflector PL80A
- ② Reflector PL40A
- ③ Reflector PL20A
- ④ PL10F reflector
- ⑤ Reflector P250 CHEM
- ⑥ Reflective tape REF-IRF-56

### Sensing range diagram

WL4S-3, WLG4S-3, 5 m

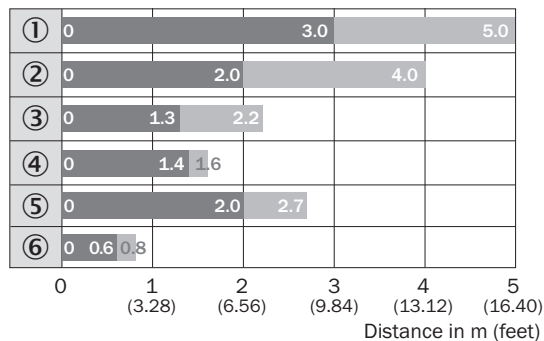

■ Sensing range      ■ Sensing range max.

- ① Reflector PL80A
- ② Reflector PL40A
- ③ Reflector PL20A
- ④ PL10F reflector
- ⑤ Reflector P250 CHEM
- ⑥ Reflective tape REF-IRF-56

### Dimensional drawing (Dimensions in mm (inch))

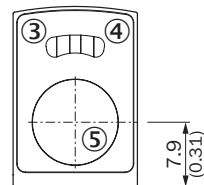
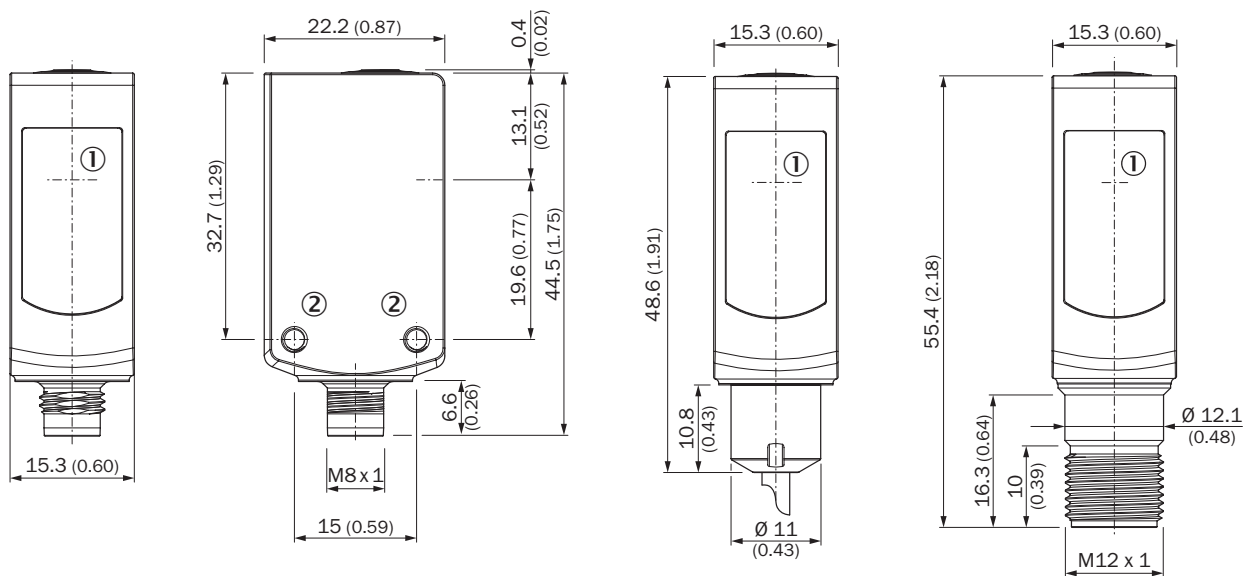

WL4S-3V, WLG4S-3V, with single teach-in button



- ① Center of optical axis
- ② Threaded mounting hole M3
- ③ LED indicator yellow: Status of received light beam
- ④ LED indicator green: Supply voltage active
- ⑤ Teach-in button

**Recommended accessories**

Other models and accessories → [www.sick.com/W4S-3\\_Inox](http://www.sick.com/W4S-3_Inox)

	<b>Brief description</b>	<b>Type</b>	<b>Part no.</b>
<b>Mounting brackets and plates</b>			
	Mounting bracket for floor mounting, Stainless steel 1.4571, mounting hardware included	BEF-W4-B	2051630
<b>Plug connectors and cables</b>			
	Head A: female connector, M8, 3-pin, straight Head B: Flying leads Cable: PP, unshielded, 5 m This product is generally resistant to chemical cleaning agents (see ECOLAB) and other chemical compounds such as H2O2 and CH2O2. Before permanent installation is carried out, the material's resistance to the cleaning agent being used must be checked., Resistant against lactic acid & hydrogen peroxide (H2O2)	DOL-0803-G05MRN	6058505
<b>Reflectors</b>			
	Chemically resistant, screw connection, 47 mm x 47 mm, plastic, Screw-on, 2 hole mounting	P250 CHEM	5321097

## SICK AT A GLANCE

SICK is one of the leading manufacturers of intelligent sensors and sensor solutions for industrial applications. A unique range of products and services creates the perfect basis for controlling processes securely and efficiently, protecting individuals from accidents and preventing damage to the environment.

We have extensive experience in a wide range of industries and understand their processes and requirements. With intelligent sensors, we can deliver exactly what our customers need. In application centers in Europe, Asia and North America, system solutions are tested and optimized in accordance with customer specifications. All this makes us a reliable supplier and development partner.

Comprehensive services complete our offering: SICK LifeTime Services provide support throughout the machine life cycle and ensure safety and productivity.

For us, that is “Sensor Intelligence.”

## WORLDWIDE PRESENCE:

Contacts and other locations –[www.sick.com](http://www.sick.com)