



WL4S-3P2130

W4S-3

MINIATURE PHOTOELECTRIC SENSORS

**SICK**  
Sensor Intelligence.



Illustration may differ



## Ordering information

Type	Part no.
WL4S-3P2130	1042069

Other models and accessories → [www.sick.com/W4S-3](http://www.sick.com/W4S-3)

## Detailed technical data

### Features

<b>Sensor/ detection principle</b>	Photoelectric retro-reflective sensor, autocollimation
<b>Dimensions (W x H x D)</b>	12.2 mm x 41.8 mm x 17.3 mm
<b>Housing design (light emission)</b>	Rectangular
<b>Sensing range max.</b>	0 m ... 4 m <sup>1)</sup>
<b>Sensing range</b>	0 m ... 2.5 m <sup>1)</sup>
<b>Type of light</b>	Visible red light
<b>Light source</b>	PinPoint LED <sup>2)</sup>
<b>Light spot size (distance)</b>	Ø 45 mm (1.5 m)
<b>Wave length</b>	650 nm
<b>Adjustment</b>	None

<sup>1)</sup> Reflector PL80A.

<sup>2)</sup> Average service life: 100,000 h at T<sub>U</sub> = +25 °C.

## Mechanics/electronics

<b>Supply voltage</b>	10 V DC ... 30 V DC <sup>1)</sup>
<b>Ripple</b>	< 5 V <sub>pp</sub> <sup>2)</sup>
<b>Power consumption</b>	20 mA <sup>3)</sup>
<b>Switching output</b>	PNP
<b>Switching mode</b>	Light switching
<b>Output current I<sub>max.</sub></b>	≤ 100 mA
<b>Response time</b>	< 0.5 ms <sup>4)</sup>
<b>Switching frequency</b>	1,000 Hz <sup>5)</sup>
<b>Connection type</b>	Connector M8, 3-pin
<b>Circuit protection</b>	A <sup>6)</sup> C <sup>7)</sup> D <sup>8)</sup>
<b>Protection class</b>	III
<b>Weight</b>	30 g
<b>Polarisation filter</b>	✓
<b>Housing material</b>	Plastic, ABS
<b>Optics material</b>	Plastic, PMMA
<b>Enclosure rating</b>	IP67 IP66
<b>Ambient operating temperature</b>	-40 °C ... +60 °C
<b>Ambient storage temperature</b>	-40 °C ... +75 °C
<b>UL File No.</b>	NRKH.E181493 & NRKH7.E181493

<sup>1)</sup> Limit values.

<sup>2)</sup> May not exceed or fall below U<sub>v</sub> tolerances.

<sup>3)</sup> Without load.

<sup>4)</sup> Signal transit time with resistive load.

<sup>5)</sup> With light/dark ratio 1:1.

<sup>6)</sup> A = V<sub>S</sub> connections reverse-polarity protected.

<sup>7)</sup> C = interference suppression.

<sup>8)</sup> D = outputs overcurrent and short-circuit protected.

## Safety-related parameters

<b>MTTF<sub>D</sub></b>	1,967 years
<b>DC<sub>avg</sub></b>	0%

## Classifications

<b>ECl@ss 5.0</b>	27270902
<b>ECl@ss 5.1.4</b>	27270902
<b>ECl@ss 6.0</b>	27270902
<b>ECl@ss 6.2</b>	27270902
<b>ECl@ss 7.0</b>	27270902
<b>ECl@ss 8.0</b>	27270902
<b>ECl@ss 8.1</b>	27270902
<b>ECl@ss 9.0</b>	27270902

<b>ECI@ss 10.0</b>	27270902
<b>ECI@ss 11.0</b>	27270902
<b>ETIM 5.0</b>	EC002717
<b>ETIM 6.0</b>	EC002717
<b>ETIM 7.0</b>	EC002717
<b>UNSPSC 16.0901</b>	39121528

### Connection diagram

Cd-045

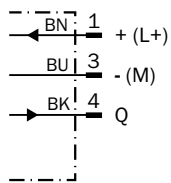

### Characteristic curve

WL4S-3

Operating reserve

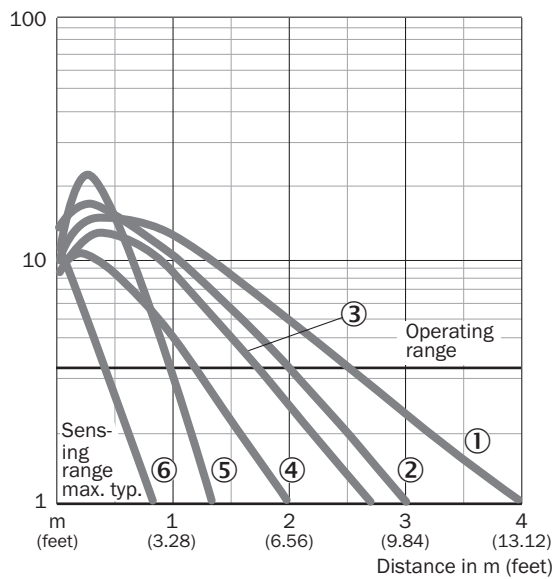

- ① Reflector PL80A
- ② Reflector P250F
- ③ Reflector PL40A
- ④ Reflector PL20F
- ⑤ PL10F reflector
- ⑥ Reflective tape REF-IRF-56

**Light spot size**

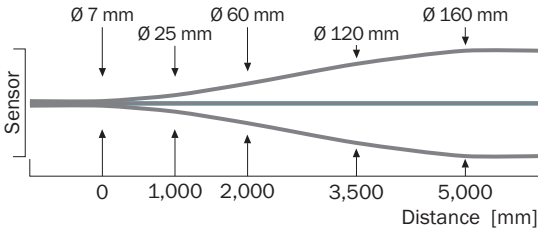

**Sensing range diagram**

WL4S-3, WLG4S-3, 4 m

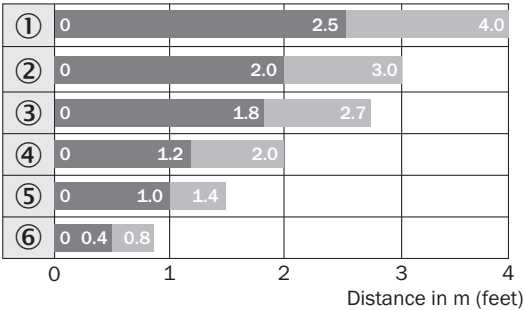

- Sensing range
- Sensing range max.
- ① Reflector PL80A
- ② Reflector P250F
- ③ Reflector PL40A
- ④ Reflector PL20F
- ⑤ PL10F reflector
- ⑥ Reflective tape REF-IRF-56

## Dimensional drawing (Dimensions in mm (inch))



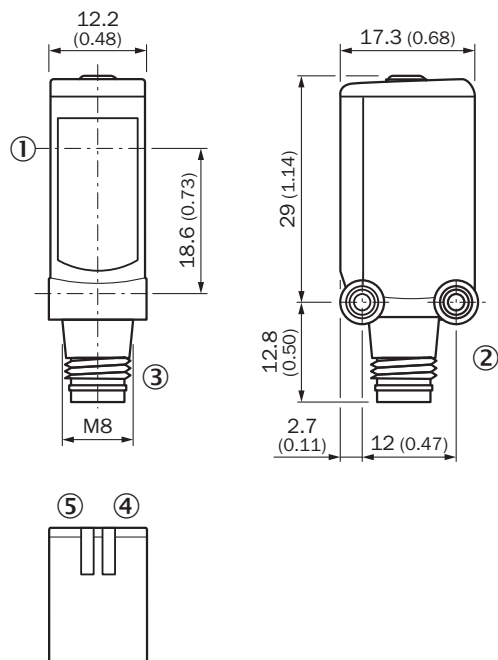

WL4S-3, WSE4S-3, potentiometer



- ① Center of optical axis
- ② Threaded mounting hole M3
- ③ Connection
- ④ LED indicator green: Supply voltage active
- ⑤ LED indicator yellow: Status of received light beam

## Recommended accessories

Other models and accessories → [www.sick.com/W4S-3](http://www.sick.com/W4S-3)

	Brief description	Type	Part no.
<b>Mounting brackets and plates</b>			
	Mounting bracket for wall mounting, Stainless steel 1.4571, mounting hardware included	BEF-W4-A	2051628
<b>Plug connectors and cables</b>			
	Head A: female connector, M8, 3-pin, straight, A-coded Head B: Flying leads Cable: Sensor/actuator cable, PVC, unshielded, 5 m	YF8U13-050VA1XLEAX	2095884
	Head A: male connector, M8, 3-pin, straight Head B: - Cable: unshielded	STE-0803-G	6037322
<b>Reflectors</b>			
	Fine triple reflector, screw connection, suitable for laser sensors, 18 mm x 18 mm, PM-MA/ABS, Screw-on, 2 hole mounting	PL10F	5311210

## SICK AT A GLANCE

SICK is one of the leading manufacturers of intelligent sensors and sensor solutions for industrial applications. A unique range of products and services creates the perfect basis for controlling processes securely and efficiently, protecting individuals from accidents and preventing damage to the environment.

We have extensive experience in a wide range of industries and understand their processes and requirements. With intelligent sensors, we can deliver exactly what our customers need. In application centers in Europe, Asia and North America, system solutions are tested and optimized in accordance with customer specifications. All this makes us a reliable supplier and development partner.

Comprehensive services complete our offering: SICK LifeTime Services provide support throughout the machine life cycle and ensure safety and productivity.

For us, that is “Sensor Intelligence.”

## WORLDWIDE PRESENCE:

Contacts and other locations –[www.sick.com](http://www.sick.com)