



GRL18S-P1338

GR18S

CYLINDRICAL PHOTOELECTRIC SENSORS

SICK
Sensor Intelligence.



Illustration may differ



Ordering information

| Type | Part no. |
|--------------|----------|
| GRL18S-P1338 | 1059536 |

Other models and accessories → www.sick.com/GR18S

Detailed technical data

Features

| | |
|--|--|
| Sensor/ detection principle | Photoelectric retro-reflective sensor, Dual lens |
| Dimensions (W x H x D) | 18 mm x 18 mm x 38.1 mm |
| Housing design (light emission) | Cylindrical |
| Thread diameter (housing) | M18 x 1 |
| Optical axis | Radial |
| Sensing range max. | 0.03 m ... 7.2 m ¹⁾ |
| Sensing range | 0.06 m ... 6 m ¹⁾ |
| Type of light | Visible red light |
| Light source | PinPoint LED ²⁾ |
| Light spot size (distance) | Ø 175 mm (7 m) |
| Wave length | 650 nm |
| Adjustment | None |

¹⁾ Reflector PL80A.

²⁾ Average service life: 100,000 h at T_U = +25 °C.

Mechanics/electronics

| | |
|--|--|
| Supply voltage | 10 V DC ... 30 V DC ¹⁾ |
| Ripple | $\pm 5 V_{pp}$ ²⁾ |
| Current consumption | 30 mA |
| Switching output | PNP |
| Switching mode | Light switching |
| Signal voltage PNP HIGH/LOW | $V_S - (\leq 3 V) / \text{approx. } 0 V$ |
| Output current I_{max} | 100 mA ³⁾ |
| Response time | $< 500 \mu s$ ⁴⁾ |
| Switching frequency | 1,000 Hz ⁵⁾ |
| Connection type | Cable, 3-wire, 2 m ⁶⁾ |
| Cable material | PVC |
| Circuit protection | A ⁷⁾ B ⁸⁾ D ⁹⁾ |
| Protection class | III |
| Polarisation filter | ✓ |
| Housing material | Plastic, ABS |
| Optics material | Plastic, PMMA |
| Enclosure rating | IP67 |
| Items supplied | Fastening nuts (2 x) |
| EMC | EN 60947-5-2 |
| Ambient operating temperature | $-25 \text{ }^\circ\text{C} \dots +55 \text{ }^\circ\text{C}$ ¹⁰⁾ |
| Ambient storage temperature | $-40 \text{ }^\circ\text{C} \dots +70 \text{ }^\circ\text{C}$ |
| UL File No. | NRKH.E348498 & NRKH7.E348498 |

¹⁾ Limit values. Operated in short-circuit protected network: max. 8 A.

²⁾ May not exceed or fall below U_V tolerances.

³⁾ At $U_V > 24 V$ or ambient temperature $> 49 \text{ }^\circ\text{C}$, $I_A \text{ max.} = 50 \text{ mA}$.

⁴⁾ Signal transit time with resistive load.

⁵⁾ With light/dark ratio 1:1.

⁶⁾ Do not bend below $0 \text{ }^\circ\text{C}$.

⁷⁾ A = V_S connections reverse-polarity protected.

⁸⁾ B = inputs and output reverse-polarity protected.

⁹⁾ D = outputs overcurrent and short-circuit protected.

¹⁰⁾ At $U_V \leq 24V$ and $I_A < 50mA$.

Classifications

| | |
|---------------------|----------|
| ECl@ss 5.0 | 27270902 |
| ECl@ss 5.1.4 | 27270902 |
| ECl@ss 6.0 | 27270902 |
| ECl@ss 6.2 | 27270902 |
| ECl@ss 7.0 | 27270902 |
| ECl@ss 8.0 | 27270902 |
| ECl@ss 8.1 | 27270902 |

| | |
|-----------------------|----------|
| ECl@ss 9.0 | 27270902 |
| ECl@ss 10.0 | 27270902 |
| ECl@ss 11.0 | 27270902 |
| ETIM 5.0 | EC002717 |
| ETIM 6.0 | EC002717 |
| ETIM 7.0 | EC002717 |
| UNSPSC 16.0901 | 39121528 |

Connection diagram

Cd-044

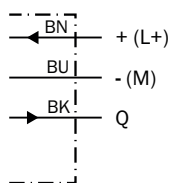

Characteristic curve

GRL18S

Operating reserve

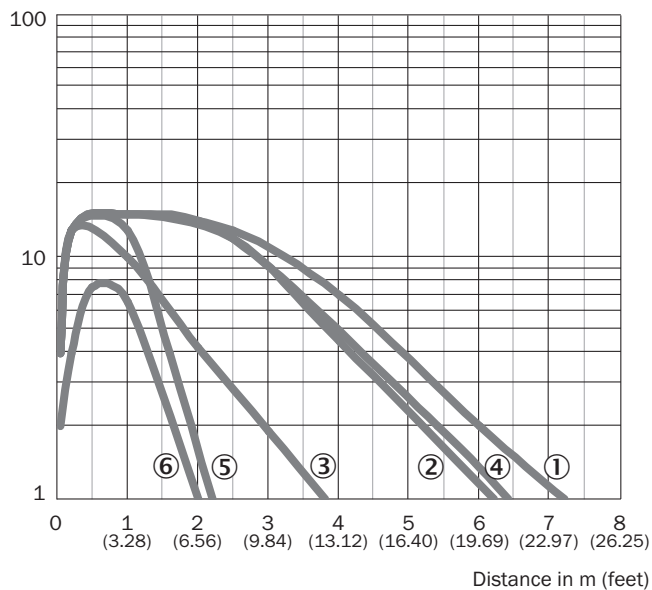

- ① Reflector PL80A
- ② Reflector PL40A
- ③ Reflector PL20A
- ④ Reflector P250
- ⑤ Reflector PL22
- ⑥ Reflective tape REF-Plus 3436

Light spot size

GRL18S

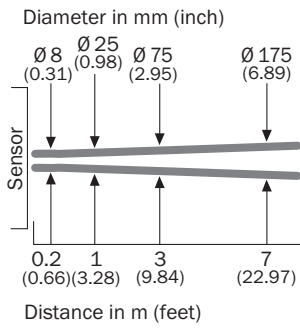

Sensing range diagram

GRL18S

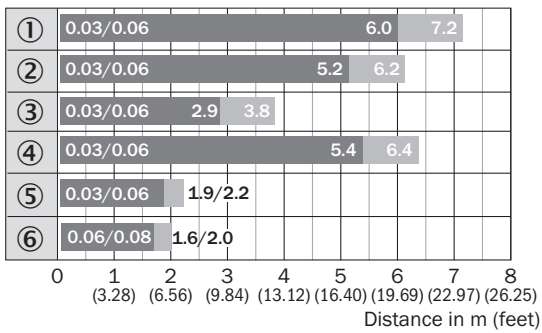

■ Sensing range ■ Sensing range max.

- ① Reflector PL80A
- ② Reflector PL40A
- ③ Reflector PL20A
- ④ Reflector P250
- ⑤ Reflector PL22
- ⑥ Reflective tape REF-Plus 3436

Dimensional drawing (Dimensions in mm (inch))



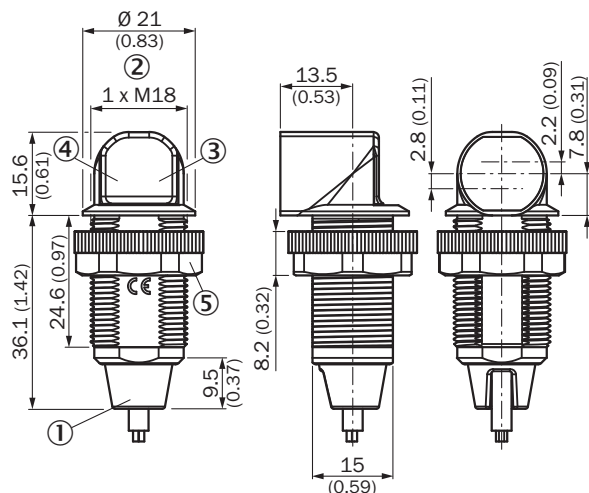

GR18S, plastic, cable, angled



- ① Connection cable 2 m
- ② Threaded mounting hole M18 x 1
- ③ LED indicator yellow
- ④ LED indicator green
- ⑤ Fastening nut; 22 mm hex, plastic

Recommended accessories

Other models and accessories → www.sick.com/GR18S

| | Brief description | Type | Part no. |
|---|---|-------------|----------|
| Mounting brackets and plates | | | |
|  | Mounting bracket for M18 sensors, steel, zinc coated, without mounting hardware | BEF-WN-M18 | 5308446 |
|  | Universal mounting bracket for reflectors, steel, zinc coated | BEF-WN-REFX | 2064574 |
| Plug connectors and cables | | | |
|  | Head A: male connector, M8, 3-pin, straight Head B: - Cable: unshielded | STE-0803-G | 6037322 |
| Reflectors | | | |
|  | Rectangular, screw connection, 47 mm x 47 mm, PMMA/ABS, Screw-on, 2 hole mounting | P250 | 5304812 |

SICK AT A GLANCE

SICK is one of the leading manufacturers of intelligent sensors and sensor solutions for industrial applications. A unique range of products and services creates the perfect basis for controlling processes securely and efficiently, protecting individuals from accidents and preventing damage to the environment.

We have extensive experience in a wide range of industries and understand their processes and requirements. With intelligent sensors, we can deliver exactly what our customers need. In application centers in Europe, Asia and North America, system solutions are tested and optimized in accordance with customer specifications. All this makes us a reliable supplier and development partner.

Comprehensive services complete our offering: SICK LifeTime Services provide support throughout the machine life cycle and ensure safety and productivity.

For us, that is “Sensor Intelligence.”

WORLDWIDE PRESENCE:

Contacts and other locations –www.sick.com