

## I/O module - AXL F AI4 U XC 1H - 2702008

Please be informed that the data shown in this PDF Document is generated from our Online Catalog. Please find the complete data in the user's documentation. Our General Terms of Use for Downloads are valid (<http://phoenixcontact.com/download>)



Axioline F XC, Analog input module, Analog inputs: 4, 0 V ... 5 V, -5 V ... 5 V, 0 V ... 10 V, -10 V ... 10 V, connection method: 2, 3, 4-wire, transmission speed in the local bus: 100 Mbps, integrated sensor supply, Extreme conditions version, degree of protection: IP20, including bus base module and Axioline F connectors

The figure shows the standard item

### Product Description

The module is designed for use within an Axioline F station. It is used to acquire analog voltage signals.

### Your advantages

- ✓ 4 analog, bipolar input channels for the connection of voltage signals
- ✓ Connection of sensors in 2, 3, and 4-wire technology
- ✓ Voltage ranges: 0 V ... 10 V, ±10 V, 0 V ... 5 V, ±5 V
- ✓ Simultaneous scanning of all channels by means of simultaneous sampling
- ✓ High crosstalk attenuation between the channels, thanks to separate signal paths
- ✓ Particularly robust against electromagnetic interference
- ✓ Device rating plate stored
- ✓ Can be used under extreme ambient conditions
- ✓ Extended temperature range of -40 °C ... +70 °C (see "Tested successfully: use under extreme ambient conditions" in the data sheet)
- ✓ Partially coated PCBs



### Key Commercial Data

Packing unit	1 pc
GTIN	 4 055626 008400
GTIN	4055626008400
Weight per Piece (excluding packing)	215.000 g
Custom tariff number	85389091
Country of origin	Germany
Note	Made to Order (non-returnable)

# I/O module - AXL F AI4 U XC 1H - 2702008

## Technical data

### Note

Utilization restriction	EMC: class A product, see manufacturer's declaration in the download area
-------------------------	---

### Dimensions

Width	35 mm
Height	126.1 mm
Depth	54 mm
Note on dimensions	The depth is valid when a TH 35-7,5 DIN rail is used (according to EN 60715).

### Ambient conditions

Ambient temperature (operation)	-25 °C ... 60 °C (Standard)
	-40 °C ... 70 °C (Extended, see section "Tested successfully: use under extreme ambient conditions" in the data sheet.)
Ambient temperature (storage/transport)	-40 °C ... 85 °C
Permissible humidity (operation)	5 % ... 95 % (non-condensing)
Permissible humidity (storage/transport)	5 % ... 95 % (non-condensing)
Air pressure (operation)	70 kPa ... 106 kPa (up to 3000 m above sea level)
Air pressure (storage/transport)	70 kPa ... 106 kPa (up to 3000 m above sea level)
Degree of protection	IP20

### Connection data

Designation	Axioline F connector
Connection method	Push-in connection
Note on the connection method	Please observe the information provided on conductor cross sections in the "Axioline F: system and installation" user manual.
Conductor cross section solid min.	0.2 mm <sup>2</sup>
Conductor cross section solid max.	1.5 mm <sup>2</sup>
Conductor cross section flexible min.	0.2 mm <sup>2</sup>
Conductor cross section flexible max.	1.5 mm <sup>2</sup>
Conductor cross section AWG min.	24
Conductor cross section AWG max.	16
Stripping length	8 mm

### General

Mounting type	DIN rail
Color	traffic grey A RAL 7042
Net weight	215 g
Note on weight specifications	with connectors and bus base module
Mounting position	any (no temperature derating)

### Interfaces

Designation	Axioline F local bus
No. of channels	2

# I/O module - AXL F AI4 U XC 1H - 2702008

## Technical data

### Interfaces

Connection method	Bus base module
Transmission speed	100 Mbps

### Axioline potentials

Designation	Axioline F local bus supply ( $U_{Bus}$ )
Supply voltage	5 V DC (via bus base module)
Current consumption	typ. 120 mA
	max. 150 mA
Power consumption	typ. 0.6 W
	max. 0.75 W
Designation	Supply for analog modules ( $U_A$ )
Supply voltage	24 V DC (I/O supply and sensor supply)
Supply voltage range	19.2 V DC ... 30 V DC (including all tolerances, including ripple)
Current consumption	max. 45 mA ( $I_{IS} = 0$ mA)
	typ. 118 mA ( $I_{IS} = 4 \times 20$ mA (nominal load))
	max. 125 mA ( $I_{IS} = 4 \times 20$ mA (nominal load))
	typ. 238 mA ( $I_{IS} = 4 \times 50$ mA (full load))
	max. 245 mA ( $I_{IS} = 4 \times 50$ mA (full load))
Power consumption	typ. 1.5 W (at $U_{Bus}$ and $U_A$ )
	max. 1.83 W (at $U_{Bus}$ and $U_A$ )
Protective circuit	Surge protection of the supply voltage electronic (35 V, 0.5 s)
	Polarity reversal protection of the supply voltage up to HW 02: polarity protection diodeas of HW 03: parallel diode; with external 5 A fuse (for startup only)
	Transient protection supply voltage Suppressor diode

### Analog inputs

Description of the input	Differential inputs, voltage
Input name	Analog inputs
Number of inputs	4
Connection method	Push-in connection
Connection technology	2, 3, 4-wire
Note regarding the connection technology	shielded, twisted pair
A/D conversion time	31.25 $\mu$ s
A/D converter resolution	16 bit
Limit frequency (3 dB)	30 Hz
	12 kHz
Type of protection	Transient protection of inputs
	Overload protection of the voltage inputs
Data formats	IB IL, S7-compatible
Measured value representation	16 bits (15 bits + sign bit)
Voltage input signal	0 V ... 5 V

## I/O module - AXL F AI4 U XC 1H - 2702008

### Technical data

#### Analog inputs

	-5 V ... 5 V
	0 V ... 10 V
	-10 V ... 10 V
Input resistance of voltage input	268 kΩ (typical)
Common mode voltage range signal - ground	-50 V DC ... 50 V DC
Input filter	30 Hz, 12 kHz and mean-value generation (can be parameterized)

#### Electrical isolation

Test section	5 V supply of the local bus ( $U_{BUS}$ ) / 24 V supply (I/Os) 500 V AC 50 Hz 1 min.
	5 V supply (logic)/analog inputs 500 V AC 50 Hz 1 min.
	5 V supply of the local bus ( $U_{BUS}$ ) / functional ground 500 V AC 50 Hz 1 min.
	24 V supply (I/O)/analog inputs 500 V AC 50 Hz 1 min.
	24 V supply (I/O) / functional earth ground 500 V AC 50 Hz 1 min.
	Analog inputs/functional earth ground 500 V AC 50 Hz 1 min.

#### Standards and Regulations

Mechanical tests	Vibration resistance in acc. with EN 60068-2-6/IEC 60068-2-6 5g
	Shock in acc. with EN 60068-2-27/IEC 60068-2-27 30g
	Continuous shock according to EN 60068-2-27/IEC 60068-2-27 10g
Protection class	III (IEC 61140, EN 61140, VDE 0140-1)

#### Environmental Product Compliance

REACH SVHC	Lead 7439-92-1
China RoHS	Environmentally Friendly Use Period = 50 years
	For details about hazardous substances go to tab "Downloads", Category "Manufacturer's declaration"

### Drawings

# I/O module - AXL F AI4 U XC 1H - 2702008

Connection diagram

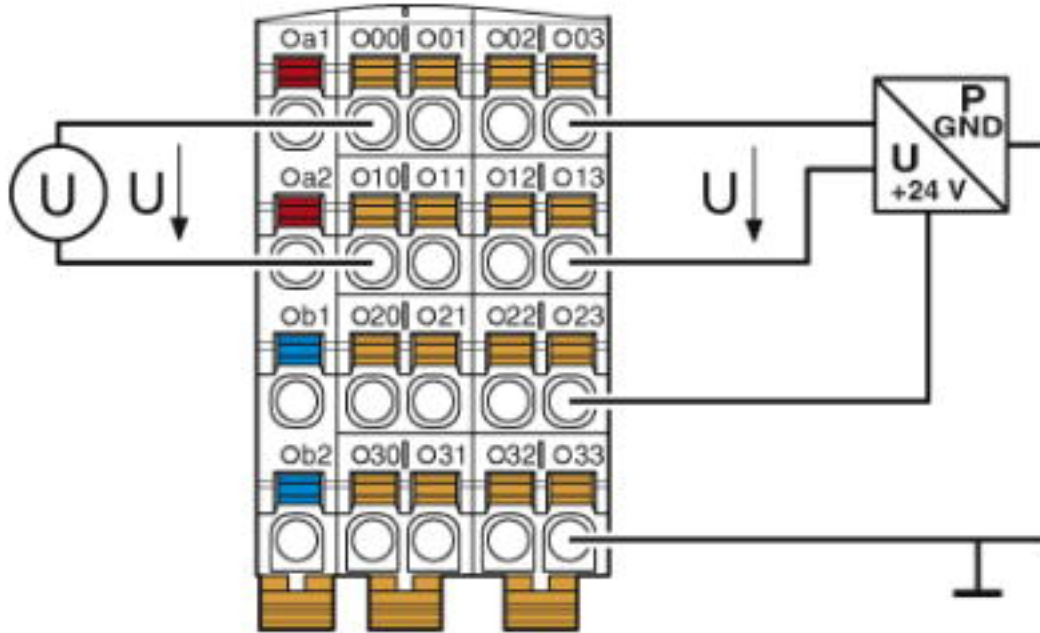

Connector for voltage measurement

# I/O module - AXL F AI4 U XC 1H - 2702008

Block diagram

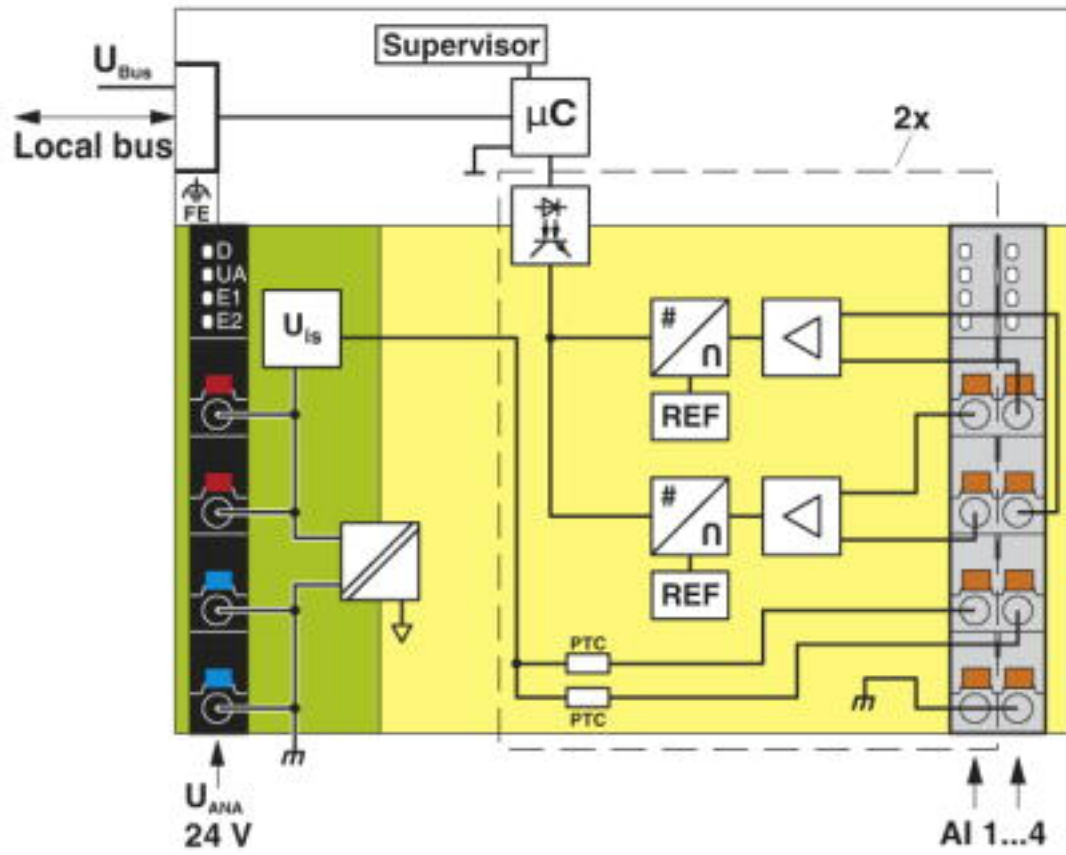

# I/O module - AXL F AI4 U XC 1H - 2702008

Dimensional drawing

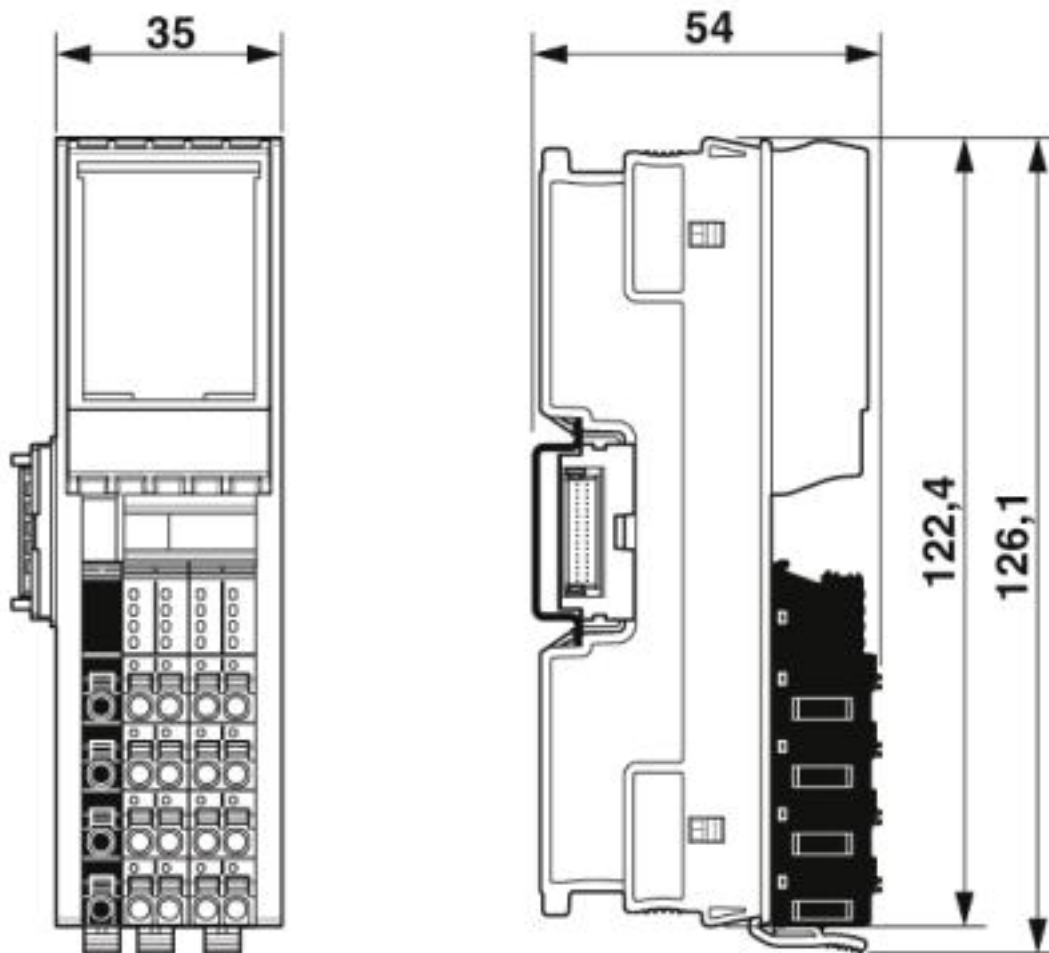

## Classifications

### eCl@ss

eCl@ss 5.1	27242600
eCl@ss 6.0	27242600
eCl@ss 7.0	27242601
eCl@ss 8.0	27242601
eCl@ss 9.0	27242601

### ETIM

ETIM 5.0	EC001596
ETIM 6.0	EC001596
ETIM 7.0	EC001596

### UNSPSC

UNSPSC 13.2	32151602
-------------	----------

# I/O module - AXL F AI4 U XC 1H - 2702008

## Classifications

### UNSPSC

UNSPSC 18.0	32151602
UNSPSC 19.0	32151602
UNSPSC 20.0	32151602
UNSPSC 21.0	32151602

## Approvals







### Approvals

#### Approvals

DNV GL / PRS / BV / LR / KR / NK / RINA / UL Listed / cUL Listed / cULus Listed

#### Ex Approvals

### Approval details

DNV GL		<a href="https://approvalfinder.dnvgl.com/">https://approvalfinder.dnvgl.com/</a>	TAA00000DF
PRS		<a href="http://www.prs.pl/">http://www.prs.pl/</a>	TE/2239/880590/19
BV		<a href="http://www.veristar.com/portal/veristarinfo/generalinfo/approved/approvedProducts/equipmentAndMaterials">http://www.veristar.com/portal/veristarinfo/generalinfo/approved/approvedProducts/equipmentAndMaterials</a>	36433/B0 BV
LR		<a href="http://www.lr.org/en">http://www.lr.org/en</a>	14-20019
KR		<a href="http://www.krs.co.kr/eng/main/main.aspx">http://www.krs.co.kr/eng/main/main.aspx</a>	HMB17372-AC002
NK		<a href="http://www.classnk.or.jp/hp/en/">http://www.classnk.or.jp/hp/en/</a>	14A006



# I/O module - AXL F AI4 U XC 1H - 2702008

## Approvals

RINA		<a href="http://www.rina.org/en">http://www.rina.org/en</a>	ELE256518XG
------	--	---	-------------

UL Listed		<a href="http://database.ul.com/cgi-bin/XYV/template/LISEXT/1FRAME/index.htm">http://database.ul.com/cgi-bin/XYV/template/LISEXT/1FRAME/index.htm</a>	FILE E 238705
-----------	--	---	---------------

cUL Listed		<a href="http://database.ul.com/cgi-bin/XYV/template/LISEXT/1FRAME/index.htm">http://database.ul.com/cgi-bin/XYV/template/LISEXT/1FRAME/index.htm</a>	FILE E 238705
------------	--	---	---------------

cULus Listed			
--------------	--	--	--

## Accessories

### Accessories

#### Device marking

Insert label - EMT (35X28)R - 0801602



Insert label, Roll, white, unlabeled, can be labeled with: THERMOMARK ROLLMASTER 300/600, THERMOMARK X1.2, THERMOMARK ROLL X1, THERMOMARK ROLL 2.0, THERMOMARK ROLL, mounting type: snapped into marker carrier, lettering field size: 35 x 28 mm, Number of individual labels: 500

---

#### DIN rail connector

Bus connector - AXL F BS H - 2700992



Axioline F bus base module for housing type H

---

#### Shield connection

## I/O module - AXL F AI4 U XC 1H - 2702008

### Accessories

Shield connection - AXL SHIELD SET - 2700518



Axioline shield connection set (contains 2 shield bus holders and 2 SK 5 shield connection clamps)

---

### Terminal marking

Zack marker strip - ZB 20,3 AXL UNPRINTED - 0829579



Zack marker strip for Axioline F (device labeling), in 2 x 20.3 mm pitch, unprinted, 25-section, for individual labeling with B-STIFT 0.8, X-PEN, or CMS-P1-PLOTTER

---

Zack Marker strip, flat - ZBF 10/5,8 AXL UNPRINTED - 0829580



Zack Marker strip, flat, Strip, white, unlabeled, can be labeled with: PLOTMARK, CMS-P1-PLOTTER, mounting type: snap into flat marker groove, for terminal block width: 10.15 mm, lettering field size: 4 of 10.15 x 5 mm and 1 of 5.8 x 5 mm, Number of individual labels: 50