

Universal control- and safety isolating- resp. isolating transformer **USTE 100/2x115**



Advantages

Universal input voltages 208 to 600 Vac

Very good switch-on behaviour thanks to reduced starting currents

High performance for the volume thanks to compact design

Very good corrosion protection and low noise thanks to BLOCKIMPEX vacuum impregnation

Quick to cable up thanks to the use of spring-loaded terminals

Contact protected screw connection terminals complying with UVV BGV A3

Simple mounting thanks to robust metal footplate with oval slots

Up to 250 VA with combination footplate for bolted and rail mounting

Applications

As a control transformer for the electrical isolation of the input and output sides. The construction of the transformer to supply control systems according to VDE 0113 is designed.

As an isolating transformer for the safe electrical isolation of the input and output sides. The transformer may be used to set up protective separation as a protective measure in accordance with VDE 0100.

As a safety isolating transformer for the safe electrical isolation of the input and output sides. The transformer is suitable for creating SELV and PELV circuits because of the limit on the output voltage.

Standards



Control transformer
to: VDE 0570 Teil 2-2, DIN EN 61558-2-2, EN 61558-2-2, IEC 61558-2-2,
UL 5085-1/-2, CSA 22.2 No.66
Isolating transformer
to: VDE 0570 Part 2-4, DIN EN 61558-2-4, EN 61558-2-4, IEC 61558-2-4,
UL 5085-1/-2, CSA 22.2 No.66

Approvals



UL 5085-1/-2, CSA 22.2 No.66



Universal control- and safety isolating- resp. isolating transformer USTE 100/2x115

Type		USTE 100/2x115
Electrical data	Input	208 Vac/230 Vac/380 Vac 400 Vac/415 Vac/440 Vac 460 Vac/480 Vac/500 Vac 525 Vac/550 Vac/575 Vac 600 Vac
	Rated input Voltage	
	Rated frequency	50 - 60 Hz
	Output	
	Rated output voltage	2 x 115 Vac
	Rated power VDE (DB cos phi=1)	100 VA
	Rated power VDE (KB cos phi=0.5)	310 VA
	No-load voltage (app. x factor)	1.07
	Efficiency	87 %
	Standards	
Classification	Control- and isolating transformer	
Approvals		
Approvals	cURus	
Environment		
Ambient temperature max.	40 °C	
Cooling method	self cooling	
Safety and protection		
Type	open type	
Class of Insulation System	VDE=B, UL=class 130	
Protection index	IP 00	
Safety class (prepared)	I	
Short circuit strength	non-short-circuit proof	
PRI Fusing recommendation by circuit breaker with tripping characteristic type 20 x I rated related to set)		
Setting range 208 - 230 Vac	0.63 - 1.00 A	
Setting value 208 - 230 Vac	0.63 A	
Setting range 380 - 415 Vac	0.25 - 0.40 A	
Setting value 380 - 415 Vac	0.34 A	
Setting range 440 +20 Vac	0.25 - 0.40 A	
Setting value 440 +20 Vac	0.31 A	
Setting range 500 -20/+25 Vac	0.25 - 0.40 A	
Setting value 500 -20/+25 Vac	0.27 A	
Setting range 575 ±25 Vac	0.16 - 0.25 A	
Setting value 575 ±25 Vac	0.24 A	
Order numbers		
Order Number	USTE 100/2x115	

Type		USTE 100/2x115
Mechanical data	Terminal and mounting	
	Terminals	Spring terminals, PE 6.3 x 0.8
	Fixing method	Dual purpose base plate also for installation on mounting rails
	Fixing screws	M4
Measures and weights		
Weight	2.10 kg	

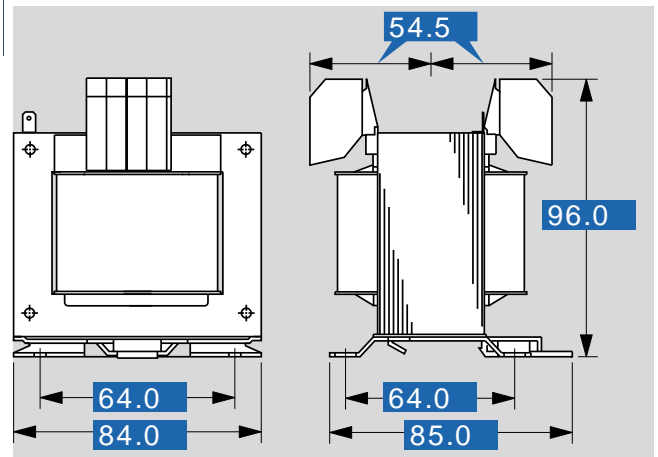

Subjects to change.