

Control- and safety isolating- resp. isolating transformer STEU 800/23



Advantages

Dual input voltage 230 and 400 Vac

Very good switch-on behaviour thanks to reduced starting currents

High performance for the volume thanks to compact design

Primary side ± 15 V tapplings for voltage adjustment

Very good corrosion protection and low noise thanks to BLOCKIMPEX vacuum impregnation

Quick to cable up thanks to the use of spring-loaded terminals

Contact protected screw connection terminals complying with UVV BGV A3

Simple mounting thanks to robust metal footplate with oval slots

Up to 250 VA with combination footplate for bolted and rail mounting

Applications

As a control transformer for the electrical isolation of the input and output sides. The construction of the transformer to supply control systems according to VDE 0113 is designed.

As an isolating transformer for the safe electrical isolation of the input and output sides. The transformer may be used to set up protective separation as a protective measure in accordance with VDE 0100.

As a safety transformer for the safe electrical isolation of the input and output sides. The transformer is suitable for creating SELV and PELV circuits because of the limit on the output voltage.

Standards



Control transformer
to: VDE 0570 Teil 2-2, DIN EN 61558-2-2, EN 61558-2-2, IEC 61558-2-2,
UL 5085-1/-2, CSA 22.2 No.66
Isolating transformer
to: VDE 0570 Part 2-4, DIN EN 61558-2-4, EN 61558-2-4, IEC 61558-2-4,
UL 5085-1/-2, CSA 22.2 No.66

Approvals



UL 5085-1/-2, CSA 22.2 No.66



Control- and safety isolating- resp. isolating transformer STEU 800/23

Type	STEU 800/23
Electrical data	
Input	
Rated input Voltage	230/400 Vac
Tappings Input	±15 V
Rated frequency	50 - 60 Hz
Output	
Rated output voltage	2 x 115 Vac
Rated power VDE (DB cos phi=1)	800 VA
Rated power VDE (KB cos phi=0.5)	3400 VA
No-load voltage (app. x factor)	1.03
Efficiency	94 %
Standards	
Classification	Control- and isolating transformer
Approvals	
Approvals	cURus
Environment	
Ambient temperature max.	40 °C
Cooling method	self cooling
Safety and protection	
Type	open type
Class of Insulation System	VDE=B, UL=class 130
Protection index	IP 00
Safety class (prepared)	I
Short circuit strength	non-short-circuit proof
PRI Fusing recommendation by circuit breaker with tripping characteristic type 20 x I _{rated} related to set)	
Setting range 230 ±15 Vac	2.50 - 4.00 A
Setting value 230 ±15 Vac	3.70 A
Setting range 400 ±15 Vac	1.60 - 2.50 A
Setting value 400 ±15 Vac	2.20 A
Order numbers	
Order Number	STEU 800/23

Type	STEU 800/23
Mechanical data	
Terminal and mounting	
Terminals	Spring terminal, PE 6.3 x 0.8
Fixing method	Base plate
Fixing screws	M6
Measures and weights	
Weight	10.30 kg

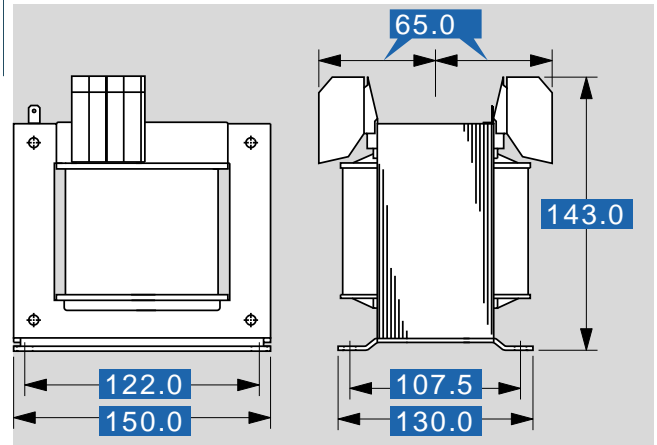

Subjects to change.