

Integrated signal lamp, single flash light, w. built-in electronic flash, clear, 115 V AC, Diameter 70 mm



General technical data	
Product designation	Flashlight element
Consumed current maximum	22 mA
Type of voltage	AC
<ul style="list-style-type: none"> <li>of the operating voltage</li> </ul>	
Operating voltage	
<ul style="list-style-type: none"> <li>1 at AC at 50 Hz rated value</li> <li>1 at AC at 60 Hz rated value</li> </ul>	115 V 115 V
Relative positive tolerance of the operating voltage	10 %
Relative negative tolerance of the operating voltage	-10 %
Reference code	
<ul style="list-style-type: none"> <li>acc. to DIN EN 81346-2</li> </ul>	P
Mounting type	Bayonet / flush mounting
Material	PC; PC/ABS; PA
Color	clear
Mechanical data	
Product component Light source	Yes
Type of electrical connection	screw-type terminals

Outer diameter of the signal column element	75 mm
---	-------





### Lamp

Design of the optical signal	flash light
Type of light source	Xenon gas discharge lamp
Light intensity	36 793 cd
Flash frequency	1 Hz
Number of flashes of light element	4 000 000

### Ambient conditions

Ambient temperature during operation	-20 ... +50 °C
Protection class IP	IP65
Depth	31 mm
Height	66 mm
Width	75 mm

### Certificates/ approvals

General Product Approval	EMC	Declaration of Conformity	other
 UL	 EAC	 RCM	 EG-Konf.
			<a href="#">Miscellaneous</a> <a href="#">Confirmation</a>

### Further information

**Information- and Downloadcenter (Catalogs, Brochures,...)**

[www.siemens.com/sirius/catalogs](http://www.siemens.com/sirius/catalogs)

**Industry Mall (Online ordering system)**

<https://mall.industry.siemens.com/mall/en/en/Catalog/product?mlfb=8WD5340-0CE>

**Cax online generator**

<http://support.automation.siemens.com/WW/CAXorder/default.aspx?lang=en&mlfb=8WD5340-0CE>

**Service&Support (Manuals, Certificates, Characteristics, FAQs,...)**

<https://support.industry.siemens.com/cs/ww/en/ps/8WD5340-0CE>

**Image database (product images, 2D dimension drawings, 3D models, device circuit diagrams, EPLAN macros, ...)**

[http://www.automation.siemens.com/bilddb/cax\\_de.aspx?mlfb=8WD5340-0CE&lang=en](http://www.automation.siemens.com/bilddb/cax_de.aspx?mlfb=8WD5340-0CE&lang=en)

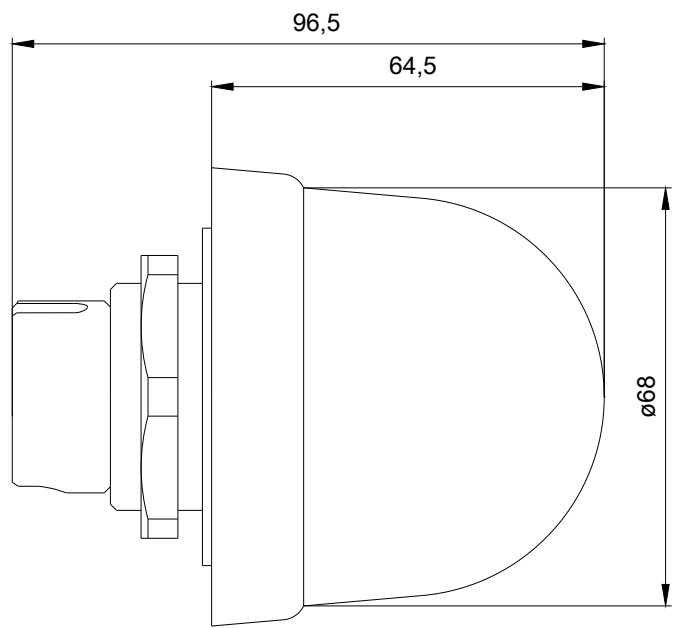
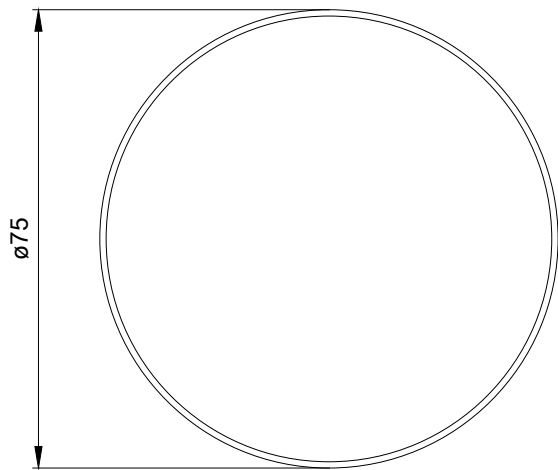

SIEMENS

last modified:

09/13/2019