

All-inclusive FX3 series

Function and performance



High-end Model FX3U FX3UC

Superior speed, power, and flexibility. Realize high speed control, network support, data logging, and more.

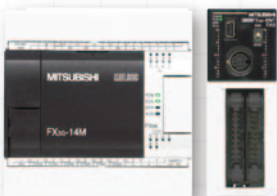

Standard Model FX3G FX3GC

From automation to network, to more advanced control. Supports features required for basic control and a variety of applications.

Entry level Model FX3S NEW

Simple and cost effective. Basic model that supports analog and communication expansion. Perfect for simple automation tasks.

FX3 series is the 3rd generation of micro programmable controllers.

High speed, large capacity, and enhanced performance and functions are assured.

Equipped with excellent expandability for analog, communication, Ethernet, and positioning functions, a whole world of FX applications awaits.

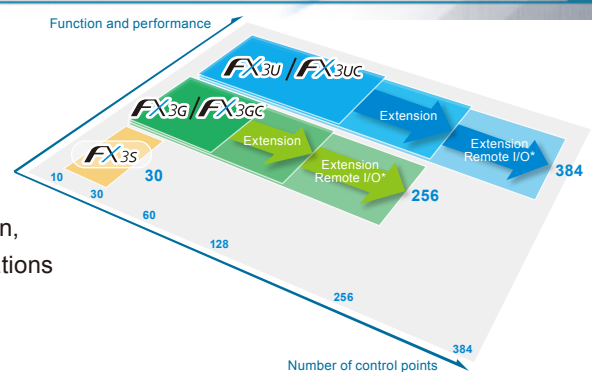

FX3 series feature comparison

Hardware	FX3S NEW	FX3G	FX3U
Main unit I/O Control size	10/14/20/30 points Max. 30 points	14/24/40/60 points Max. 128 points (Max. 256 with remote I/O*)	16/32/48/64/80/128 points Max. 256 points (Max. 384 with remote I/O*)
Power supply	AC	AC, DC	AC, DC
24 V DC input	Sink/Source	Sink/Source	Sink/Source
Output	Relay Type Transistor Type	Relay Type Transistor Type	Relay Type Transistor Type
Internal memory	16,000 steps EEPROM (program capacity is limited to 4,000 steps.)	32,000 steps EEPROM	64,000 steps RAM (Battery backed)
Communication port	USB/RS-422	USB/RS-422	RS-422 (USB option)
High-speed counter	1-phase 60 kHz : 2 points 10 kHz : 4 points	1-phase 60 kHz : 4 points 10 kHz : 2 points	1-phase 100 kHz : 6 points 10 kHz : 2 points
Positioning control (transistor output type)	2 axes 100 kHz	14/24 Point type : 2 axes 40/60 Point type : 3 axes 100 kHz	3 axes 100 kHz
Variable analog potentiometer	2 points	2 points	—

*: Remote I/O is CC-Link I/O.

PROGRAMMABLE CONTROLLERS

•Power Supply Specifications

Item	Specification			
	FX3s-10M-E	FX3s-14M-E	FX3s-20M-E	FX3s-30M-E
Supply voltage	100 to 240 V AC	100 to 240 V AC	100 to 240 V AC	100 to 240 V AC
Allowable supply voltage range	86 to 264 V AC			
Rated frequency	50/60 Hz			
Allowable instantaneous power failure time	Operation can be continued upon occurrence of instantaneous power failure for 10 ms or less.			
Power fuse	250 V 1 A			
Rush current	15 A max. 5 ms or less/100 V AC, 28 A max. 5 ms or less/200 V AC			
Power consumption*1	19 W	19 W	20 W	21 W
24 V DC service power supply	400 mA			

*1: This item shows values when all 24 V DC service power supplies are used in the maximum configuration connectable to the main unit, and includes the input current (5 or 7 mA per point).

•24 V DC input (sink/source) specifications
(Please see the manual for input circuit configuration.)

Item	Specification			
	FX3s-10M	FX3s-14M	FX3s-20M	FX3s-30M
Number of input points	6 points	8 points	12 points	16 points
Input connecting type	Fixed terminal block (M3 screw)			
Input form	Sink/Source			
Input signal voltage	24 V DC +10%, -10%			
Input impedance	X000 to X007	3.3 k Ω		
	X010 to X017	4.3 k Ω		
Input signal current	X000 to X007	7 mA/24 V DC		
	X010 to X017	5 mA/24 V DC		
ON input sensitivity current	X000 to X007	4.5 mA or more		
	X010 to X017	3.5 mA or more		
OFF input sensitivity current	1.5 mA or less			
Input response time	Approx. 10 ms			
Input signal form	No-voltage contact input NPN open collector transistor			
Source input	No-voltage contact input PNP open collector transistor			
Input circuit insulation	Photocoupler insulation			
Input operation display	LED on panel lights when photocoupler is driven.			

•Relay output specifications
(Please see the manual for output circuit configuration.)

Item	Relay output specification			
	FX3s-10M/ES	FX3s-14M/ES	FX3s-20M/ES	FX3s-30M/ES
Number of output points	4 points	6 points	8 points	14 points
Output connecting type	Fixed terminal block (M3 screw)			
Output form	Relay			
External power supply	30 V DC or less, 240 V AC or less (250 V AC or less when the unit does not comply with CE, UL or cUL standards.)			
Max. load	2 A point The total load current of resistance loads per common terminal should be the following value. + 1 output point/common terminal: 2 A or less + 4 output points/common terminal: 8 A or less 80 VA (UL and cUL standards approved at 120 and 240 V AC)			
Min. load	5 V DC, 2 mA (reference value)			
Open circuit leakage current	2 A point			
Response OFF-ON time	Approx. 10 ms			
Output circuit insulation	Mechanical insulation			
Output operation display	LED on panel lights when power is applied to relay coil.			

•Transistor output specifications
(Please see the manual for output circuit configuration.)

Item	Transistor output specification			
	FX3s-10M/ES	FX3s-14M/ES	FX3s-20M/ES	FX3s-30M/ES
Number of output points	4 points	6 points	8 points	14 points
Output form	Transistor/sink output (FX3s-ES/MT/ES) Transistor/source output (FX3s-ES/MT/SS)			
External power supply	5 to 30 V DC			
Max. load	0.5 A point The total load current of resistance loads per common terminal should be the following value. + 1 output point/common terminal: 0.5 A or less + 4 output points/common terminal: 0.8 A or less 12 W/24 V DC The total inductive loads per common terminal should be the following value. + 1 output point/common terminal: 12 W or less/ 24 V DC + 4 output points/common terminal: 19.2 W or less/24 V DC			
Open circuit leakage current	0.1 mA or less/30 V DC			
ON voltage	1.5 V or less			
Response OFF-ON time	Y000, Y001: 5 μ s or less/10 mA or more (5 to 24 V DC) Y002 to Y015: 0.2 ms or less/200 mA or more (24 V DC)			
Output circuit insulation	Photocoupler insulation			
Output operation display	LED on panel lights when photocoupler is driven.			

•Performance specifications
(General specification is the same as that of FX3U series. Please see the "MELSEC FX-FAMILY" catalog.)

Item	Specification	
	FX3U	FX3UC
Operation control system	Stored program repetitive operation system with interruption function.	
Input/output control system	Batch processing system (when END instruction is executed) Input/output refresh instruction and pulse catch function are provided.	
Programming language	Relay symbol system + step-ladder system (SFC notation possible)	
Program memory	Built-in memory capacity: 16,000 steps/EEPROM memory (Program capacity is 4,000 steps) Max. allowable write: 20,000 times Memory cassette (Option): 32,000 steps/EEPROM memory (with loader function) The FX3s series PLC is available only to 16,000 steps. (Program capacity is 4,000 steps.) Max. allowable write: 10,000 times	
Writing function during power failure	Provided (Program can be modified while the PLC is running.)	
Keyword function	With keyword/Custom keyword function	
Real-time clock	Clock function*2: Built-in 1800 to 2079 (with correction for leap year) 2- or 4-digit year, accuracy within 45 seconds/month at 25 °C	
Basic instructions	Sequence instructions: 29 Step-ladder instructions: 2	
Applied instructions	116 kinds	
Processing speed	0.21 μ s/instruction	
Input points	16 points or less (Extension is impossible.)	
Output points	14 points or less (Extension is impossible.)	
Input relay	X000 to X017 The device numbers are octal.	
Output relay	Y000 to Y015	
Auxiliary relay	For general: M0 to M383 384 points EEPROM keep: M384 to M511 128 points For special: M512 to M535 204 points For special: M8000 to M8511 512 points	
State	For initial state (EEPROM keep): S0 to S9 10 points For general: S10 to S127 118 points EEPROM keep: S128 to S255 128 points	
Timer (on-delay timer)	T0 to T31 32 points 0.1 to 3,276.7 sec 100 ms/10 ms T32 to T62 31 points 0.1 to 3,276.7 sec/0.01 to 100.0 sec When M8028 is driven ON, timers T32 to T62 (31 points) are changed to 10 ms resolution.	
1 ms accumulating type	T63 to T127 65 points 0.001 to 32,767 sec	
1 ms accumulating type	T128 to T131 4 points 0.001 to 32,767 sec	
100 ms accumulating type	T132 to T137 6 points 0.1 to 3,276.7 sec	
Variable analog potentiometer	Available as analog timers: VR1: D8030 VR2: D8031	
Counter	16 bits up (For general): C0 to C15 16 points Counting from 0 to 32,767 16 bits up (EEPROM keep): C16 to C31 16 points Counting from 0 to 32,767 32 bits up/down (For general): C32 to C234 95 points Counting from -2,147,483,648 to +2,147,483,647 Counting from -2,147,483,648 to +2,147,483,647	
High-speed counter	1-phase 1-count input in both directions (32 bits up/down) (EEPROM keep): C235 to C245 1-phase 2-count input in both directions (32 bits up/down) (EEPROM keep): C246 to C250 2-phase 2-count input in both directions (32 bits up/down) (EEPROM keep): C251 to C255	
Data register (32 bits when (EEPROM keep))	For general (16 bits): D0 to D127 128 points For EEPROM keep (16 bits): D128 to D255 128 points For general (16 bits): D256 to D2999 2744 points File register (EEPROM keep): D1000 to D2999 Max. Can be set as file registers in units of 500 points from D1000 in the program area (EEPROM) using parameters.	
Pointer	For special (16 bits): D8000 to D8511 512 points For index (16 bits): V0 to V7 16 points P0 to P255 256 points For C/J instructions and CALL instructions Input interruption: I0 to I7 8 points Timer interruption: T0 to T7 8 points For MC instructions	
Nesting	For master control: N0 to N7 8 points For MC instructions	
Constant	Decimal number (K): 16 bits -32,768 to +32,767 32 bits -2,147,483,648 to +2,147,483,647 Hexadecimal number (H): 16 bits 0 to FFFF 32 bits 0 to FFFFFFFF Real number (E): 32 bits 1.0×2^{128} to -1.0×2^{-128} , 0 , 1.0×2^{-128} to 1.0×2^{128} Decimal-point and exponential notations are possible.	
Software/peripheral equipment	GX Works2: Version 1.492N or later*3 FX-3GP: Version 1.50 or later	

*2: The current time of the clock is backed up by the capacitor built-in the PLC. Supply the power to the PLC for 30 minutes or more to completely charge this large-capacity capacitor.
(The capacitor works for 10 days (atmosphere: 25 °C))
*3: To program FX3s in GX Developer, select FX3s as the PLC type. Please read the FX3s series user's manual about limitations.

Safety Warning
To ensure proper use of the products in this document, please be sure to read the instruction manual prior to use.

Registration
• Ethernet is a trademark of Xerox Corporation in the United States.
• MODBUS is a registered trademark of Schneider Electric SA.
• All other company names and product names used in this document are trademarks or registered trademarks of their respective companies.

MITSUBISHI ELECTRIC CORPORATION
HEAD OFFICE: TOKYO BLDG., 2-7-3, MARUNOUCHI, CHIYODA-KU, TOKYO 100-8310, JAPAN
<http://Global.MitsubishiElectric.com>



PROGRAMMABLE CONTROLLERS MELSEC-F

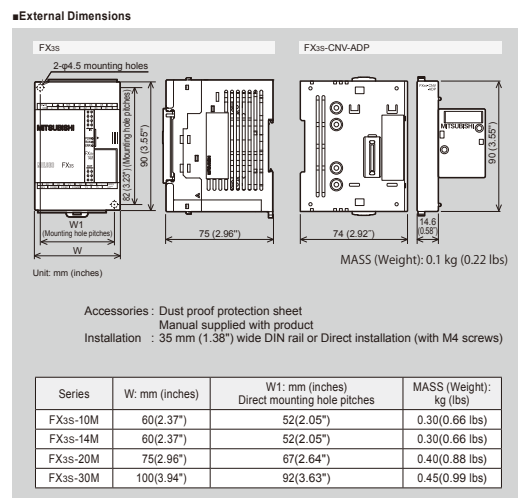

•Product specification

Series	Model name	Power Supply	Input Specifications		Output Specifications		
			Number of points	Input type	Number of points	Output type	
Main Units	FX3s-10MR/ES	100 to 240 V AC	6	24 V DC (Sink/Source)	4	Relay	
	FX3s-10MT/ES		6	4	Transistor (Sink)		
	FX3s-10MT/ESS		6	4	Transistor (Source)		
	FX3s-14MR/ES		8	6	Relay		
	FX3s-14MT/ES		8	6	Transistor (Sink)		
	FX3s-14MT/ESS		8	6	Transistor (Source)		
	FX3s-20MR/ES		12	8	Relay		
	FX3s-20MT/ES		12	8	Transistor (Sink)		
	FX3s-20MT/ESS		12	8	Transistor (Source)		
	FX3s-30MR/ES		16	14	Relay		
	FX3s-30MT/ES		16	14	Transistor (Sink)		
	FX3s-30MT/ESS		16	14	Transistor (Source)		
Connector conversion adapter	FX3s-CNV-ADP	Special adapter connection conversion adapter					
Special adapters	FX3U-232ADP-MB	For RS-232C(MODBUS)communication					
	FX3U-485ADP-MB	For RS-485(MODBUS)communication					
	FX3U-ENET-ADP-F	For Ethernet communication					
	FX3U-4AD-ADP	4-ch voltage/current input					
	FX3U-4DA-ADP	4-ch voltage/current output					
	FX3U-3A-ADP	2-ch voltage/current input 1-ch voltage/current output					
	FX3U-4AD-PT-ADP	4-ch platinum resistance thermometer sensor input (-50 to +250 °C)					
	FX3U-4AD-PTW-ADP	4-ch platinum resistance thermometer sensor input (-100 to +600 °C)					
	FX3U-4AD-PNS-ADP	4-ch PT100/NI1000 resistance thermometer sensor input					
	FX3U-4AD-TC-ADP	4-ch thermocouple (K, J type) temperature sensor input					
Expansion boards	FX3G-232-BD	For RS-232C communication					
	FX3G-422-BD	For RS-422 communication					
	FX3G-485-BD	For RS-485 communication					
	FX3G-8AV-BD	For 8-ch Analog volume					
	FX3G-2AD-BD	2-ch voltage/current input					
	FX3G-1DA-BD	1-ch voltage/current output					
	Memory cassette	FX3G-EEPROM-32L	32,000 steps EEPROM memory (with transfer switch)*5				
			*4: FX3U-ENET-ADP Ver. 1.20 or later is applicable to the FX3s series PLC. *5: FX3s series PLC can hold 16,000 steps of memory, but user program capacity is limited to 4,000 steps.				

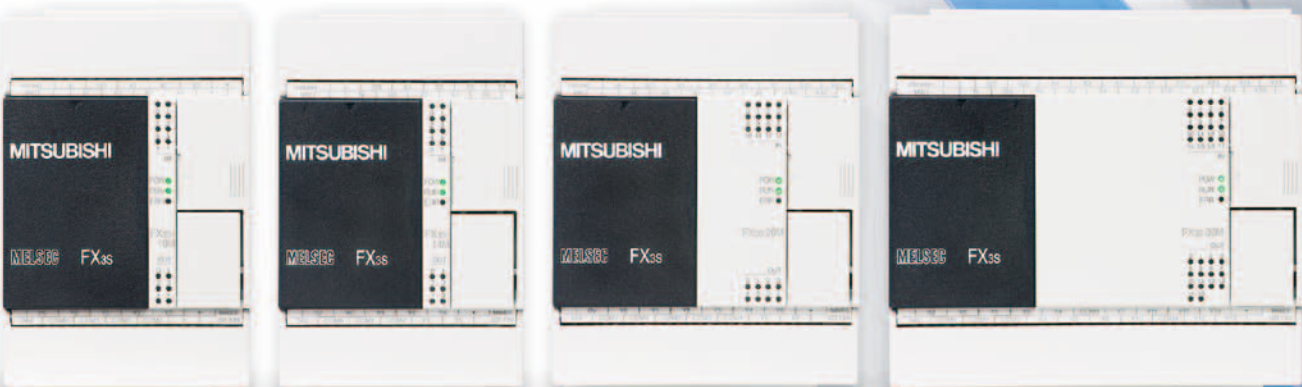

New possibilities

- Introducing an entry level model for the FX3 series -



Empowering Industries

FX3S

NEW

The newly released FX3s adds extra expandability to the high cost performance of the venerable entry-level FX1s.

FX3s makes it possible to utilize analog, Ethernet and MODBUS® functions even in small-scale systems.

New possibilities

Main unit lineup



FX3s-10MR/ES	AC D R	FX3s-20MR/ES	AC D R	FX3s-30MR/ES	AC D R
FX3s-10MT/ES	AC D T1	FX3s-20MT/ES	AC D T1	FX3s-30MT/ES	AC D T1
FX3s-10MT/ESS	AC D T2	FX3s-20MT/ESS	AC D T2	FX3s-30MT/ESS	AC D T2
6 inputs 4 outputs		12 inputs 8 outputs		16 inputs 14 outputs	
FX3s-14MR/ES	AC D R				
FX3s-14MT/ES	AC D T1				
FX3s-14MT/ESS	AC D T2				
8 inputs 6 outputs					

AC AC power supply D DC input (sink/source)
R Relay output T1 Transistor output (sink) T2 Transistor output (source)

System configuration example

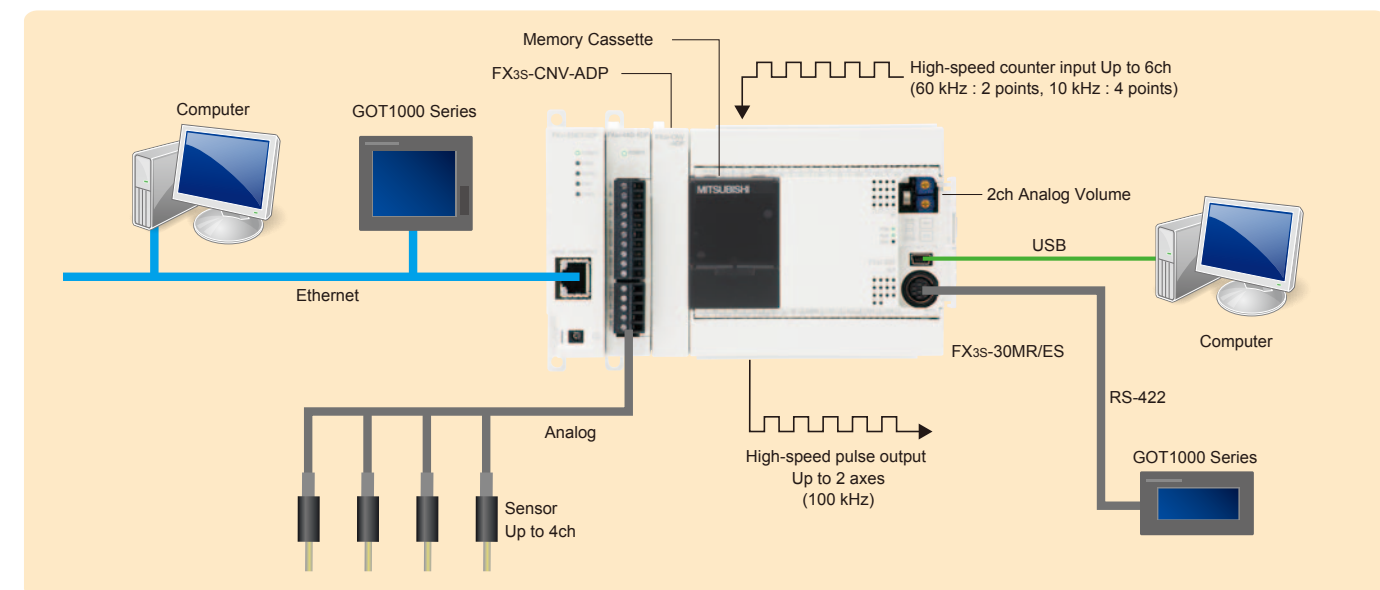

Excellent cost performance!

Equipped with the performance of FX3 series while maintaining backwards compatibility with FX1s.

High-speed operation

- FX3s processes basic instructions in 0.21 μs, which is faster by approximately 3 times compared with FX1s.

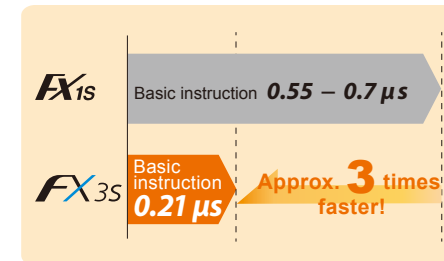

Increased program capacity

- Up to 4,000 steps program capacity.
- 2,000 steps file register capacity.
- Up to 12,000 steps for comments.
In total, the built-in EEPROM of the FX3s can store up to 16,000 steps.

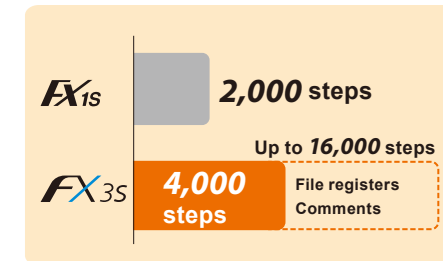

More instructions

- Supports inverter communication instructions.
- Supports floating point instructions.
- Supports 116 applied instructions (31 more instructions than FX1s).

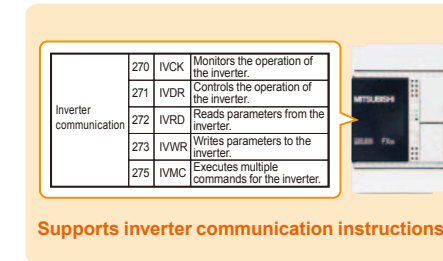

Enhanced communication functions

- Built-in USB (MINI B) port and RS-422 port.
- 115.2 kbps serial communication.
USB port supports 12 Mbps communication speed.

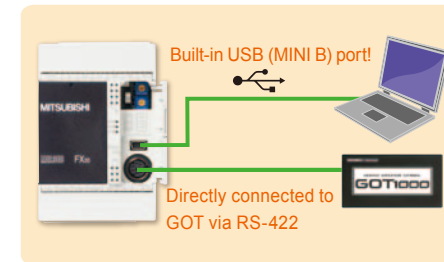

Enhanced analog expandability

- Analog expansion board can be connected.
- Special analog adapter can be connected.
- Analog input adapter for temperature sensor can be connected.



Compatibility with global standards

- Conforms to the EC Directive and UL Standard.
- Conforms to the Radio Law in South Korea.
- Select between sink and source inputs.



Unprecedented expandability with optional products!

Analog, Ethernet and MODBUS products can be connected.

Enhanced expandability

- Special adapter for Ethernet can be connected.
- Special adapter for serial communication (compatible with MODBUS) can be connected.

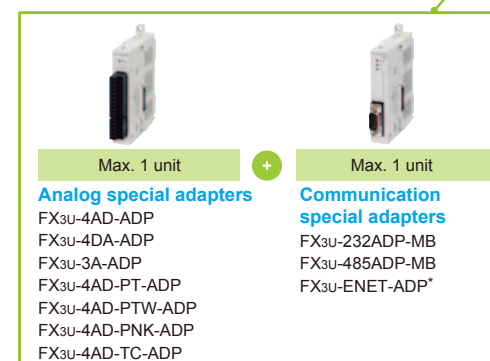
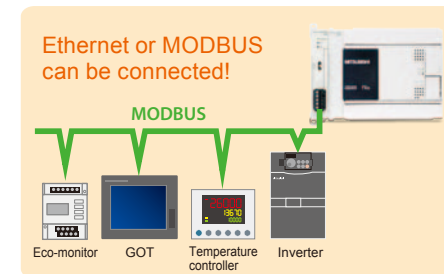

Up to two special adapters (up to one analog adapter and up to one communication adapter) can be connected. (Restrictions with expansion board connections exist.)
* : When using FX3u-ENET-ADP, connect it at the last stage (left end) of adapters.

Optional product configuration diagram

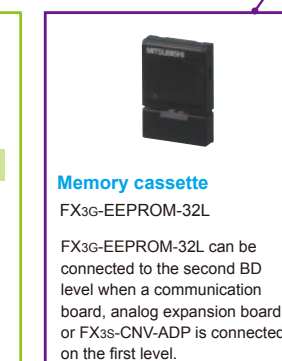
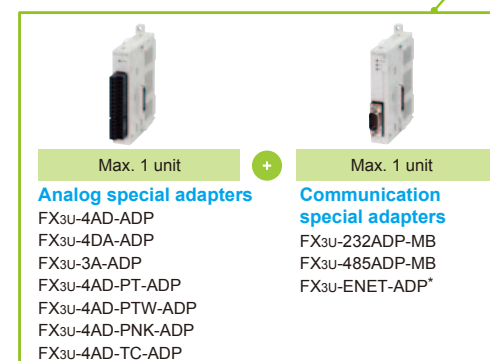
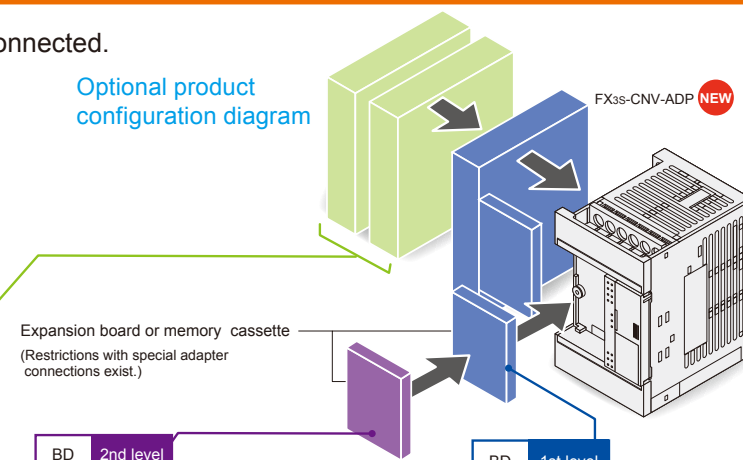

New possibilities using FX3s

Achieve extensive cost reductions by flexibly combining FX3s with other PLCs.

For example, by properly distributing PLCs in a network in accordance with the desired application, you can reduce loads on each CPU and costs of the entire system. In addition, you can construct an energy-saving system by combining with power monitoring functions.

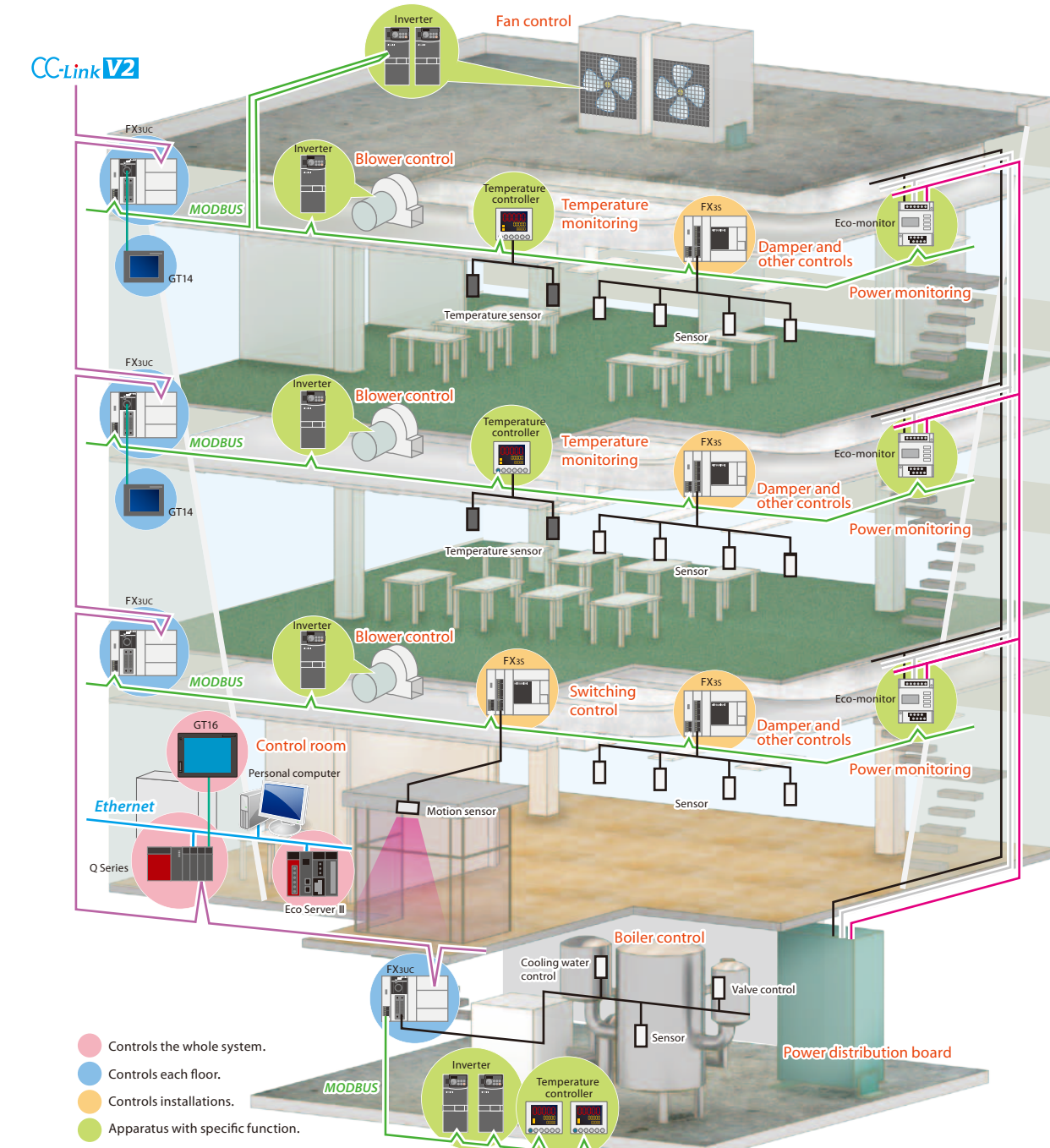

Straightforward programming with GX Works2

Powerful, intuitive, and efficient. GX Works2 reduces program development time with an easy-to-use interface.

Use GX Works2 also for setting up Ethernet.

FX3u-ENET-ADP



PLC engineering software

GX Works2