



**Main switchRear mounting**



Powering Business Worldwide™

**Part no. P3-63/V/SVB-SW**

**Article no. 060230**

Front IP65

**Delivery programme**

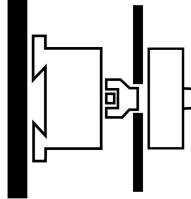
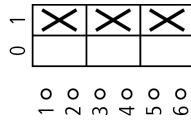
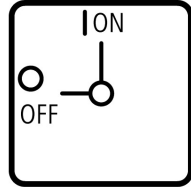
Product range			Switch-disconnectors
Basic function			Main switches Maintenance switches Manual override switches
Part group reference			P3
Design			Rear mounting
			
Protection type			Front IP65
Emergency stop			without emergency switching off/emergency stop function
			With black rotary handle and locking ring
Locking facility			Lockable in the 0 (Off) position
			without auxiliary contacts
Contact sequence			
Front plate no.			 <b>FS 908</b>
Main conducting paths			
No. of poles		M	3
Auxiliary contacts		N/O	0
		B	0
Max. motor rating			
AC-23A			
400/415 V 50-60 Hz			
400 V	P	kW	30
Rated uninterrupted current	I <sub>u</sub>	A	63

**Approvals**

Product Standards  
UL File No.  
UL CCN  
CSA File No.  
CSA Class No.  
NA Certification  
Suitable for  
Degree of Protection

UL 508; CSA-C22.2 No. 14-05; IEC/EN 60947-3; CE marking  
E36332  
NLRV  
12528  
3211-05  
UL listed, CSA certified  
Branch circuits, suitable as motor disconnect  
IEC: IP65; UL/CSA Type 3R, 12

**General**

Standards			IEC/EN 60947, VDE 0660, IEC/EN 60204, CSA, UL switch disconnecter according to IEC/EN 60947-3
Lifespan, mechanical	Operations	$x 10^6$	0.1
Maximum operating frequency		Operations/h	50
Climatic proofing			Damp heat, constant, to IEC 60068-2-78; Damp heat, cyclical, to IEC 60068-2-30
Ambient temperature		°C	
Open		°C	- 25 - 50
Enclosed		°C	- 25 - 40
Mounting position			As required
Mechanical shock resistance to IEC 60068-2-27	Half-sinusoidal shock 20 ms	g	> 15

## Contacts

Rated operational voltage	$U_e$	V AC	690
Rated impulse withstand voltage	$U_{imp}$	V AC	6000
Overvoltage category/pollution degree			III/3
Rated uninterrupted current	$I_u$	A	
open	$I_u$	A	63
Enclosed	$I_u$	A	63
Load rating with intermittent operation, class 12			
AB 25 % DF		$x I_e$	2
AB 40 % DF		$x I_e$	1.6
AB 60 % DF		$x I_e$	1.3
Short-circuit rating			
Fuse		A gG/ gL	80
Rated short-time withstand current (1 s current)	$I_{cw}$	$A_{rms}$	1260
Switching angles		°	90
Current heat loss per contact at $I_e$		W	4.5

## Terminal capacities

Solid or stranded		mm <sup>2</sup>	1 x (2.5 - 35) 2 x (2.5 - 10)
Flexible with ferrules to DIN 46228		mm <sup>2</sup>	
Flexible with ferrule		mm <sup>2</sup>	1 x (1.5 - 25) 2 x (1.5 - 6)
Terminal screw			M5
Tightening torque		Nm	3

## Switching capacity

AC		$x U_s$	
Rated making capacity $\cos \varphi = 0.35$		A	800
Rated breaking capacity, motor load switch $\cos \varphi = 0.35$		A	
230 V		A	640
400 V		A	600
500 V		A	590
690 V		A	340
Rated operational current 440 V load-break switch AC-21A	$I_e$	A	63
Rating, AC-3 motor load switch	P	kW	
220 V 230 V	P	kW	15
380 V 400 V	P	kW	30
500 V	P	kW	30
660 V 690 V	P	kW	20
AC-23A Motor load switches (main switches maintenance switches)	P	kW	
230 V	P	kW	18.5

400 V	P	kW	30
500 V	P	kW	37
690 V	P	kW	50
DC		$x U_s$	
DC-1, Load-break switches L/R = 1 ms			
Rated operational current	$I_e$	A	63
Voltage per contact pair in series		V	60
DC-23A, motor load switch L/R = 15 ms			
24 V			
Rated operational current	$I_e$	A	50
Contacts		Quantity	1
48 V			
Rated operational current	$I_e$	A	50
Contacts		Quantity	2
60 V			
Rated operational current	$I_e$	A	50
Contacts		Quantity	3
120 V			
Rated operational current	$I_e$	A	25
Contacts		Quantity	3

## Notes

**Notes** Main switch characteristics to IEC/EN 60204; positive opening of contacts, operator element positively located on shaft  
The rated uninterrupted current  $I_u$  is stated at max. connected cross-section.  
For terminal capacity solid, stranded and flexible:  
Max. 2 cross-section sizes difference admissible when using 2 conductors.

## Technical data ETIM 4.0

Number of auxiliary contacts as normally open contact			0
Number of auxiliary contacts as normally closed contact			0
Rated permanent current $I_u$		A	63
Number of poles			3
Conditioned rated short-circuit current $I_q$		kA	0
Degree of protection (IP), front side			IP55
Number of auxiliary contacts as change-over contact			0
Interlockable			YES
Motor drive integrated			No
Connection type main current circuit			Screw connection
Version as emergency stop installation			No
Type of control element			Door coupling rotary drive
Version as main switch			YES
Version as switch disconnecter compact			YES
Version as safety switch			No
Version as maintenance-/service switch			YES
Rated operation power at AC-23, 400V		kWh	37
Rated operation power AC-3, 400 V		kWh	30
Suitable for ground mounting			No
Suitable for front mounting			No
Suitable for front mounting center			No
Suitable for distribution board installation			No
Suitable for intermediate mounting			No
Max. rated operation voltage $U_e$ AC		V	690
Motor drive optional			No
Voltage release optional			No
Device construction			Built-in device fixed built-in technique

## Characteristics

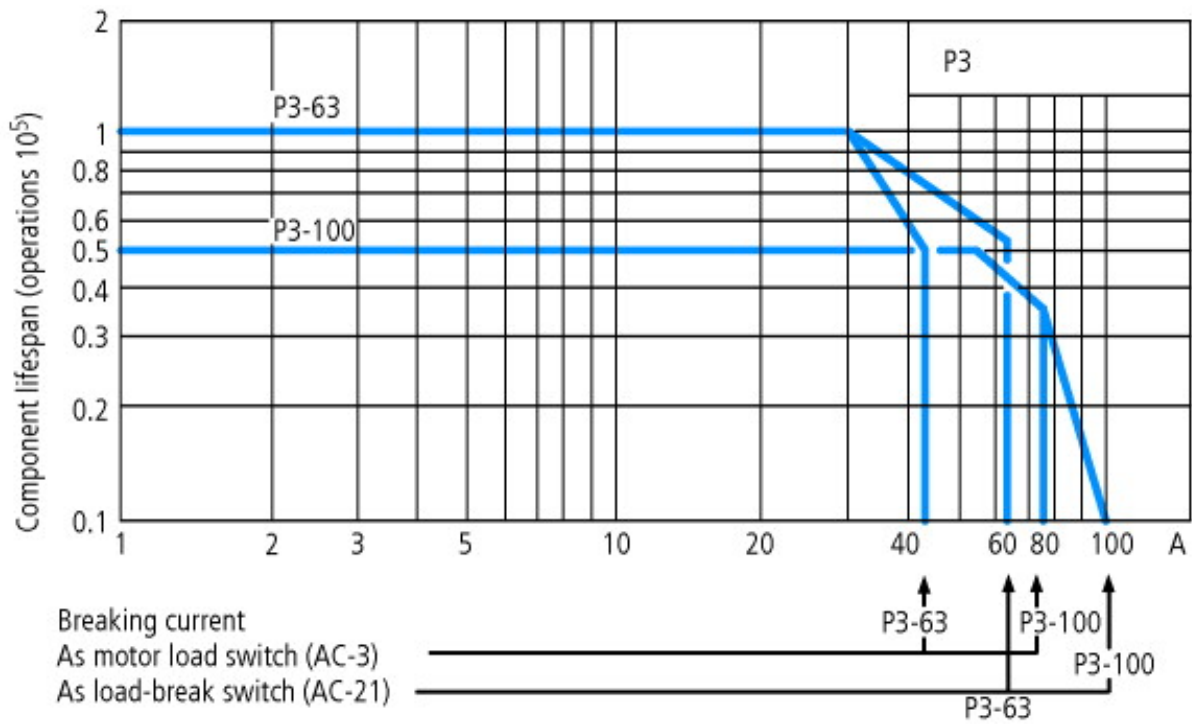

For utilisation category AC-4 (extreme load: 100 % inching, reversing or plugging)

The blocked rotor current of the motor should not exceed the rated current of the switch for AC-21A to ensure a reasonable device lifespan.

## Dimensions

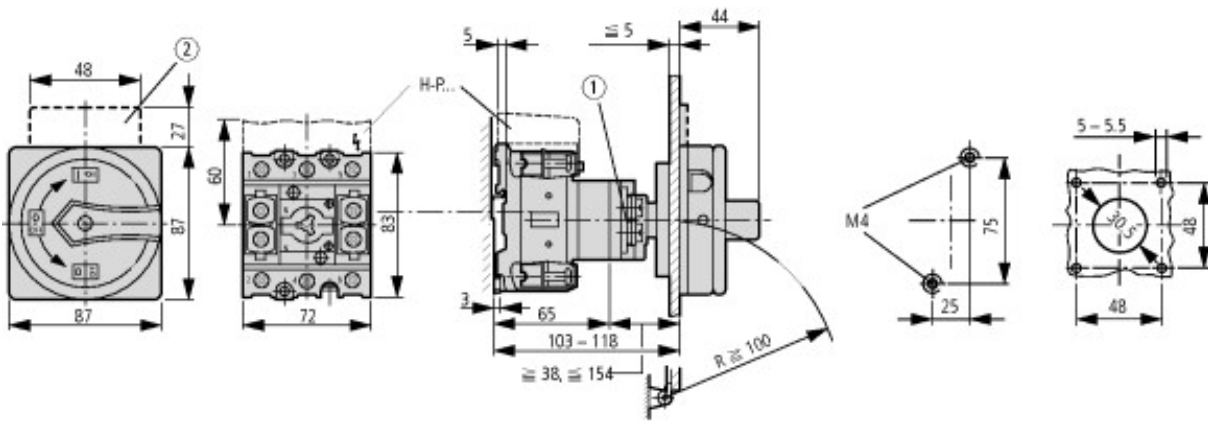

① Shaft can be extended using ZVV-... + ZAV-..., max.  $F 4 \times 25 = 100$  mm

② Not included

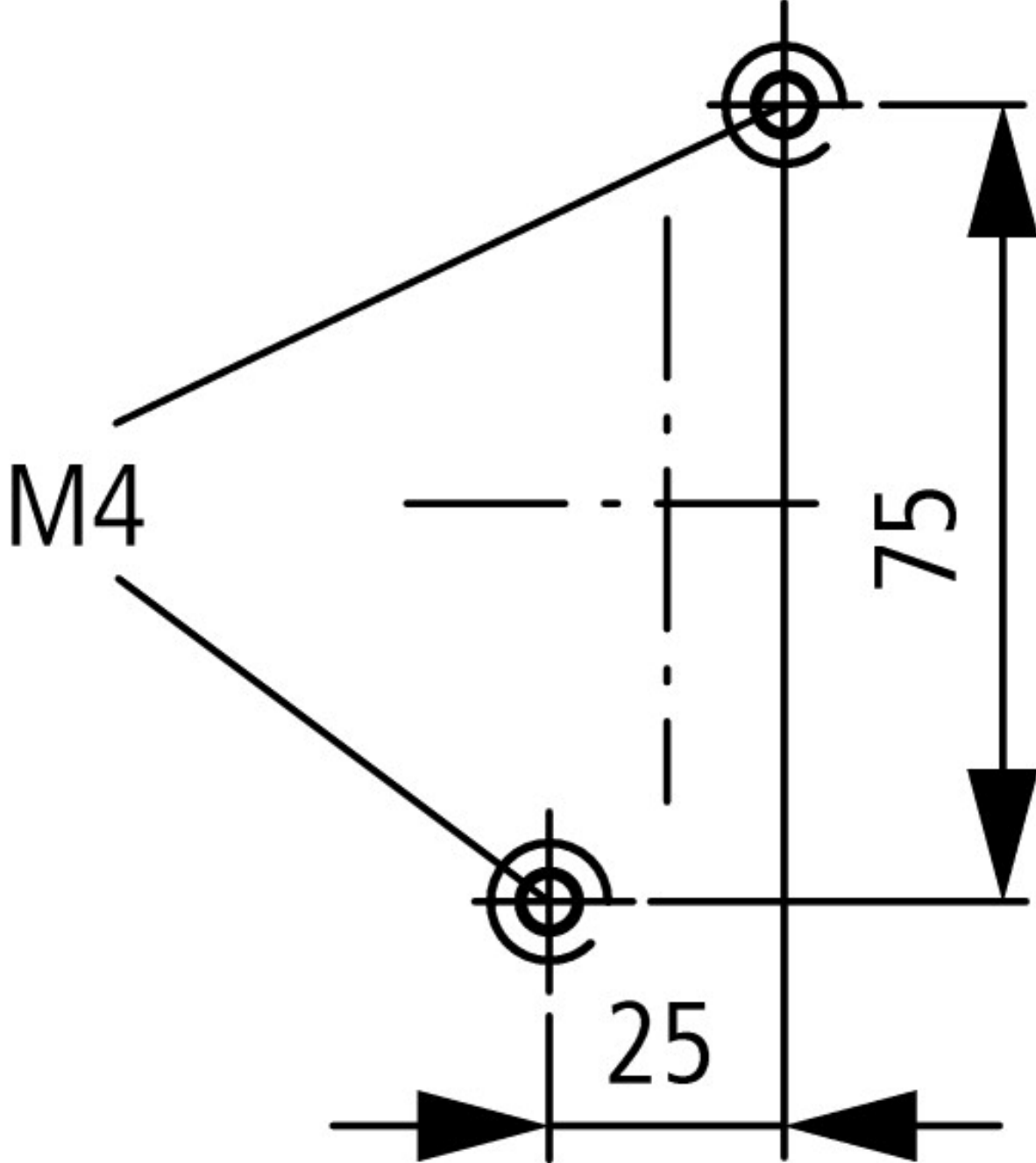

Diameter of drilled hole Bottom

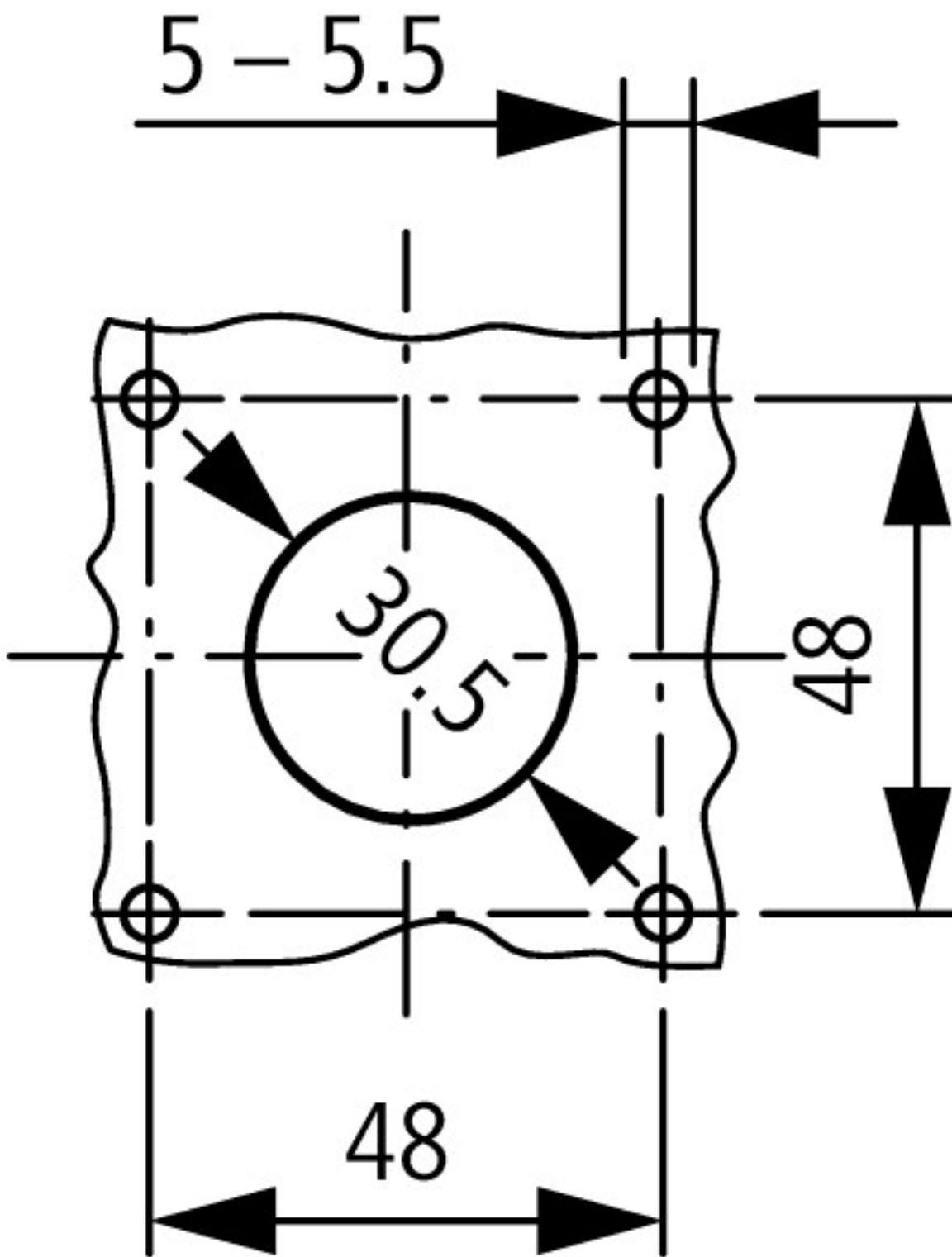

Diameter of drilled hole Door

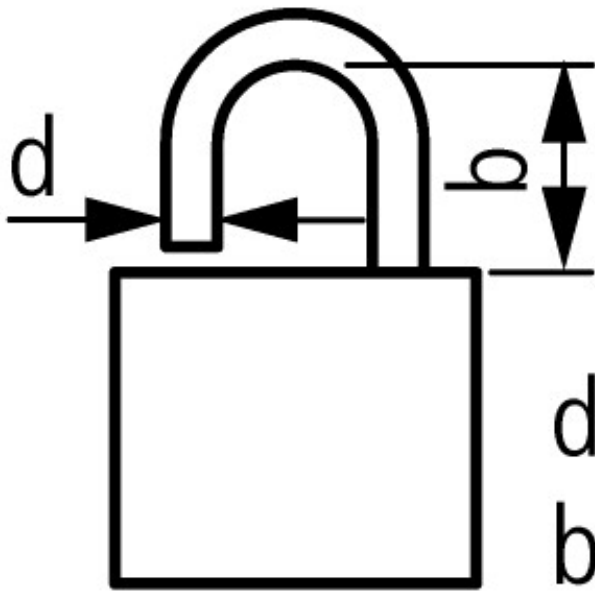

$$d = 4 - 8 \text{ mm}$$
$$b + d \leq 47 \text{ mm}$$

 3 Padlocks

#### Additional product information (links)

IL03802005Z (AWA1150-1981) Switch-Disconnectors for flush mounting

IL03802005Z (AWA1150-1981) Switch-Disconnectors for flush mounting

[ftp://ftp.moeller.net/DOCUMENTATION/AWA\\_INSTRUCTIONS/IL03802005Z2012\\_06.pdf](ftp://ftp.moeller.net/DOCUMENTATION/AWA_INSTRUCTIONS/IL03802005Z2012_06.pdf)

<http://ecat.moeller.net/flip-cat/?edition=HPLEN&startpage=4.87>