



## Main

Range of product	Modicon TM5
Product or component type	Power distribution module with internal fuse
Product specific application	Supply 24 V DC I/O modules and bus TM5

## Complementary

Range compatibility	Modicon LMC058 Modicon M258
Product compatibility	Motion controller Logic controller
[Us] rated supply voltage	24 V
Network type	DC
Current supplied	740 mA for TM5 power bus 55...60 °C 1136 mA for TM5 power bus -10...55 °C 6.3 A for I/O power segment
Power dissipation in W	<= 2.13 W
Colour	Grey
Short circuit protection	6.3 A with internal fuse
Current consumption	<= 34 mA 24 V DC
Marking	CE
Product weight	0.030 kg

## Environment

Standards	CSA 22-2 No 142 IEC 61131-2 UL 508 CSA 22-2 No 213
Product certifications	CSA C-Tick CULus GOST-R
Ambient air temperature for operation	55...60 °C with derating factorhorizontal installation -10...55 °C without derating factorhorizontal installation -10...50 °C vertical installation
Ambient air temperature for storage	-25...70 °C
Relative humidity	5...95 % without condensation
Operating altitude	0...2000 m
Storage altitude	0...3000 m
Vibration resistance	3.5 mm 5...8.4 Hz DIN rail 1 gn 8.4...150 Hz DIN rail
Shock resistance	15 gn for 11 ms
Resistance to electrostatic discharge	8 kV in air conforming to EN/IEC 61000-4-2 4 kV on contact conforming to EN/IEC 61000-4-2
Resistance to electromagnetic fields	10 V/m 80...2000 MHz conforming to EN/IEC 61000-4-3 1 V/m 2...2.7 GHz conforming to EN/IEC 61000-4-3

Resistance to fast transients	2 kV power lines conforming to EN/IEC 61000-4-4 1 kV shielded cable conforming to EN/IEC 61000-4-4 1 kV I/O conforming to EN/IEC 61000-4-4
Surge withstand	1 kV common mode conforming to EN/IEC 61000-4-5 0.5 kV differential mode conforming to EN/IEC 61000-4-5
Electromagnetic compatibility	EN/IEC 61000-4-6
Disturbance radiated/conducted	CISPR11

### Offer Sustainability

Sustainable offer status	Not Green Premium product
RoHS	Compliant - since 1039 - Schneider Electric declaration of conformity <a href="#">download declaration of conformity</a>

TM5 Slice

Dimensions

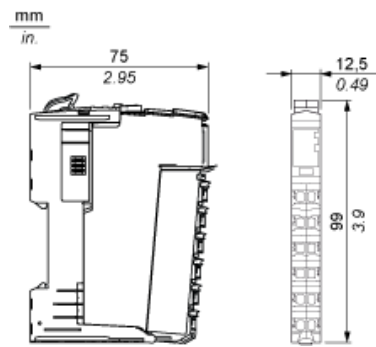

TM5 System

Spacing Requirements





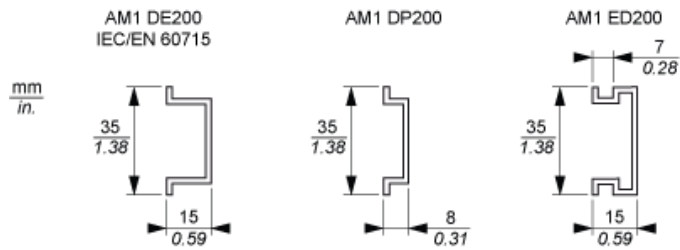

Mounting on a DIN Rail



TM5 System Wiring Recommendations

Wire Sizes to Use with the Removable Spring Terminal Blocks

mm in.				
mm <sup>2</sup>	0,08...2,5	0,25...2,5	0,25...1,5	2 x 0,25...2 x 0,75
AWG	28...14	24...14	24...16	2 x 24...2 x 18

PDM Electronic Module 24 Vdc I/O Fuse 6.3 A and TM5 Power Bus

Wiring Diagram

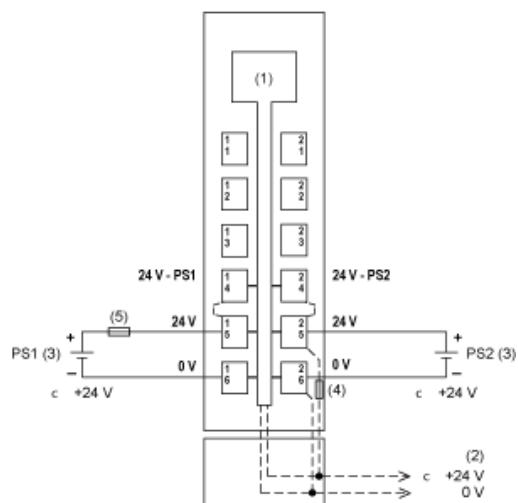

- (1) Internal electronics
- (2) 24 Vdc I/O power segment integrated into the bus bases
- (3) PS1/PS2: External isolated SELV power supplies limited to 200 VA for UL508 conformance, or limited to 150 VA for CSA 22.2, N° 142 conformance
- (4) Integrated fuse type T slow-blow 10 A 250 V exchangeable
- (5) External fuse type T slow-blow 1 A 250 V