



Main

Range of product	Modicon TM5
Product or component type	Analog input module
Analogue input number	6
Analogue input type	Thermocouple - 50...1768 °C thermocouple S Thermocouple - 270...1372 °C thermocouple K Thermocouple - 270...1300 °C thermocouple N Thermocouple - 210...1200 °C thermocouple J
Analogue input resolution	16 bits

Complementary

Range compatibility	Modicon LMC058 Modicon M258
Product compatibility	Motion controller Logic controller
Measurement resolution	0.1 °C
Colour	White
Input filtering	1...66.7 ms configurable by software
Measurement error	+/- 0.17 % of full scale, - 50...1768 °C thermocouple S at 25 °C +/- 0.11 % of full scale, - 270...1372 °C thermocouple K at 25 °C +/- 0.11 % of full scale, - 270...1300 °C thermocouple N at 25 °C +/- 0.1 % of full scale, - 210...1200 °C thermocouple J at 25 °C
Temperature coefficient	0.01 %FS/°C, analogue input type: thermocouple
Non-linearity	+/- 0.001 %FS, analogue input type: thermocouple
Type of cable	Shielded cable
Isolation	No insulation between channels 500 Vrms AC insulation between channel and bus
Supply	Internal
[Us] rated supply voltage	24 V DC -15...20 %
Common mode rejection	>= 70 dB
Local signalling	6 LEDs green for input status 1 LED red for power supply 1 LED green for power supply
Current consumption	38 mA 24 V DC input/output 2 mA 5 V DC bus
Power dissipation in W	<= 0.92 W
Marking	CE
Product weight	0.025 kg

Environment

Standards	CSA 22-2 No 142 IEC 61131-2 UL 508 CSA 22-2 No 213
Product certifications	CSA C-Tick CULus GOST-R
Ambient air temperature for operation	0...60 °C with derating factor (horizontal installation) 0...55 °C without derating factor (horizontal installation) 0...50 °C (vertical installation)
Ambient air temperature for storage	-25...70 °C
Relative humidity	5...95 % without condensation
IP degree of protection	IP20 conforming to IEC 61131-2
Pollution degree	2 conforming to IEC 60664
Operating altitude	0...2000 m
Storage altitude	0...3000 m
Vibration resistance	3.5 mm (f= 5...8.4 Hz) DIN rail 1 gn (f= 8.4...150 Hz) DIN rail
Shock resistance	15 gn for 11 ms
Resistance to electrostatic discharge	8 kV in air conforming to EN/IEC 61000-4-2 4 kV on contact conforming to EN/IEC 61000-4-2
Resistance to electromagnetic fields	10 V/m 80...2000 MHz conforming to EN/IEC 61000-4-3 1 V/m 2...2.7 GHz conforming to EN/IEC 61000-4-3
Resistance to fast transients	2 kV power lines conforming to EN/IEC 61000-4-4 1 kV shielded cable conforming to EN/IEC 61000-4-4 1 kV I/O conforming to EN/IEC 61000-4-4
Surge withstand	1 kV common mode conforming to EN/IEC 61000-4-5 0.5 kV differential mode conforming to EN/IEC 61000-4-5
Electromagnetic compatibility	EN/IEC 61000-4-6
Disturbance radiated/conducted	CISPR11

Offer Sustainability

Sustainable offer status	Not Green Premium product
RoHS	Compliant - since 1039 - Schneider Electric declaration of conformity download declaration of conformity

TM5 Slice

Dimensions

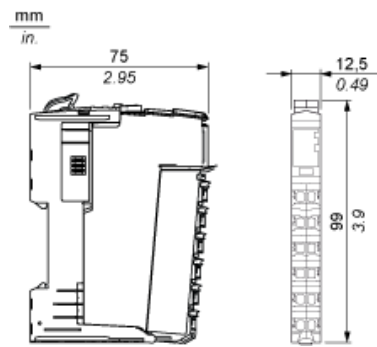

TM5 System

Spacing Requirements

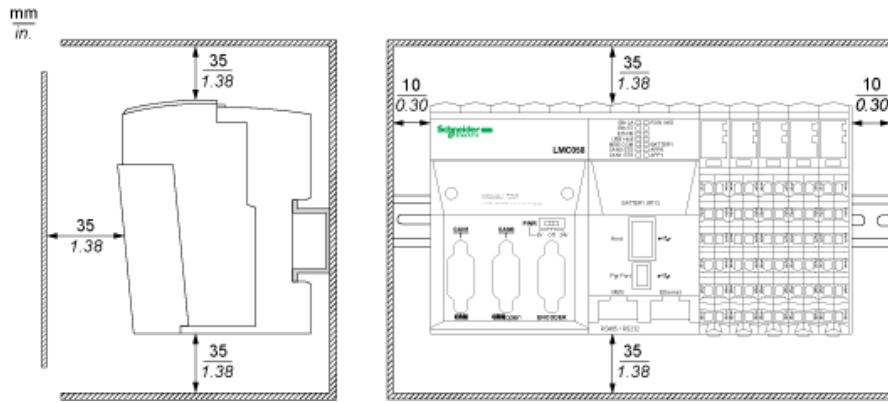



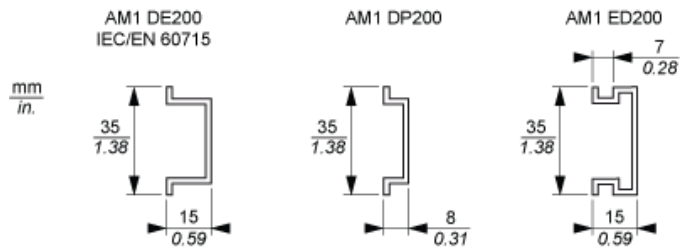

Mounting on a DIN Rail



TM5 System Wiring Recommendations

Wire Sizes to Use with the Removable Spring Terminal Blocks

mm in.				
mm ²	0,08...2,5	0,25...2,5	0,25...1,5	2 x 0,25...2 x 0,75
AWG	28...14	24...14	24...16	2 x 24...2 x 18

Electronic Module 6AI Thermocouple J/K/N/S 16 Bits

Wiring Diagram

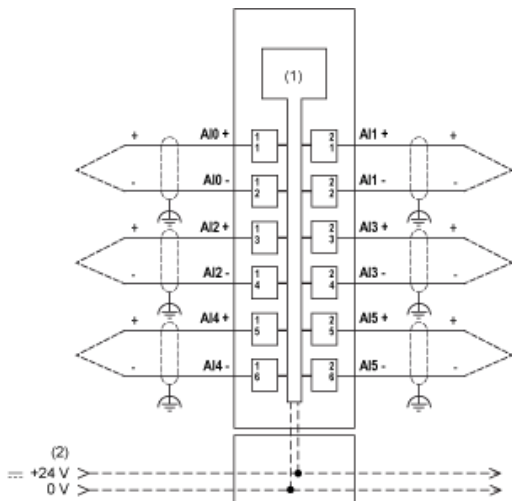

- (1) Internal electronics
- (2) 24 Vdc I/O power segment integrated into the bus bases

Ceramic Heating Element with Integrated Thermo Elements

Ripple voltage effects can potentially cause measurement errors.

The following figure shows the wiring diagram with a PDM:

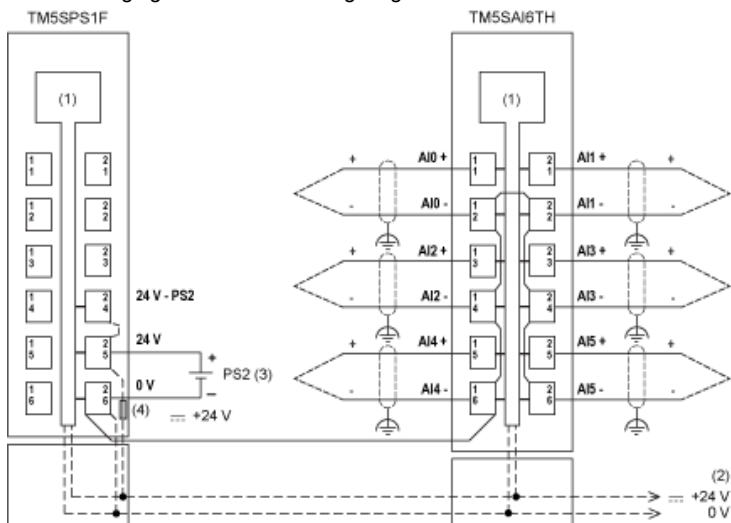

- (1) Internal electronics
- (2) 24 Vdc I/O power segment integrated into the bus bases
- (3) PS2: External isolated SELV power supply 24 Vdc limited to 200 VA for UL508 conformance, or limited to 150 VA for CSA 22.2, N° 142 conformance
- (4) Integrated fuse type T slow-blow 6.3 A 250 V exchangeable