



SIRIUS POSITION SWITCH METAL ENCLOSURE 56MM WIDE DEVICE CONNECTION 3X (M20X1.5) 1NO/1NC SNAP-ACTION CONTACTS ROTARY ACTUATOR RIGHT/LEFT ADJUSTABLE, W. METAL LEVER 27MM LONG AND PLASTIC ROLLER 19MM

Manufacturer article number

- of the basic unit included in the scope of supply
- of the actuator head for position switches included in the scope of supply
- of the operating lever included in the scope of supply

[3SE5122-0CA00](#)

[3SE5000-0AH00](#)

[3SE5000-0AA01](#)

General technical details:

product designation

standard position switch

Explosion protection category for dust

none

Insulation voltage

- rated value

V

400

Degree of pollution

class 3

Thermal current

A

6

Operating current

- at AC-15
 - at 24 V / rated value
 - at 125 V / rated value
 - at 230 V / rated value
 - at 400 V / rated value
- at DC-13
 - at 24 V / rated value
 - at 125 V / rated value

A

6

A

6

A

6

A

4

A







3

A

0.55

<ul style="list-style-type: none"> • at 230 V / rated value • at 400 V / rated value 	A	0.27
	A	0.1
Continuous current		
<ul style="list-style-type: none"> • of the slow DIAZED fuse link • of the quick DIAZED fuse link • of the C characteristic circuit breaker 	A	6
	A	10
	A	1
Mechanical operating cycles as operating time		
<ul style="list-style-type: none"> • typical 		15,000,000
Electrical operating cycles as operating time		
<ul style="list-style-type: none"> • with contactor 3RH11, 3RT1016, 3RT1017, 3RT1024, 3RT1025, 3RT1026 / typical • at AC-15 / at 230 V / typical 		10,000,000
		100,000
Electrical operating cycles in one hour		
<ul style="list-style-type: none"> • with contactor 3RH11, 3RT1016, 3RT1017, 3RT1024, 3RT1025, 3RT1026 		6,000
Repeat accuracy	mm	0.05
Design of the contact element		snap-action contacts
Number of NC contacts		
<ul style="list-style-type: none"> • for auxiliary contacts 		1
Design of the switching function		positive opening
Number of NO contacts		
<ul style="list-style-type: none"> • for auxiliary contacts 		1
Resistance against vibration		0.35 mm / 5g
Resistance against shock		30g / 11 ms
Ambient temperature		
<ul style="list-style-type: none"> • during operating • during storage 	°C	-25 ... +85
	°C	-40 ... +90
Width of the sensor	mm	56
Material		
<ul style="list-style-type: none"> • of the enclosure 		metal
Material / of the housing / of the switch head		metal
Design of the operating mechanism		metal lever, 27 mm long, step 9 mm, plastic roller 19 mm
Actuating speed	mm/s / m/s	0.1 ... 1.5
Protection class IP		IP66/IP67
mounting position		any
Cable gland version		3 x (M20 x 1.5)
Design of the electrical connection		screw-type terminals
Item designation		
<ul style="list-style-type: none"> • according to DIN 40719 extendable after IEC 204-2 		S

Certificates/approvals:

General Product Approval			For use in hazardous locations	Functional Safety / Safety of Machinery
 CCC	 GOST	 UL	 VDE	 ATEX
 VDE				
Declaration of Conformity	Test Certificates	other		
 EG-Konf.	Special Test Certificate	Declaration of the Compliance with the order	Confirmation	

Further information:

Information- and Downloadcenter (Catalogs, Brochures,...)

<http://www.siemens.com/industrial-controls/catalogs>

Industry Mall (Online ordering system)

<http://www.siemens.com/industrial-controls/mall>

CAX-Online-Generator

<http://www.siemens.com/cax>

Service&Support (Manuals, Certificates, Characteristics, FAQs,...)

<http://support.automation.siemens.com/WW/view/en/3SE5122-0CH01/all>

Image database (product images, 2D dimension drawings, 3D models, device circuit diagrams, ...)

http://www.automation.siemens.com/bilddb/cax_en.aspx?mlfb=3SE5122-0CH01

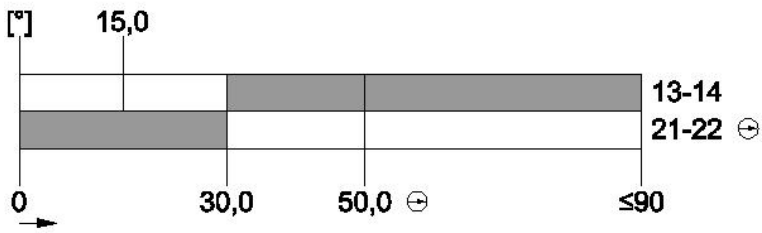
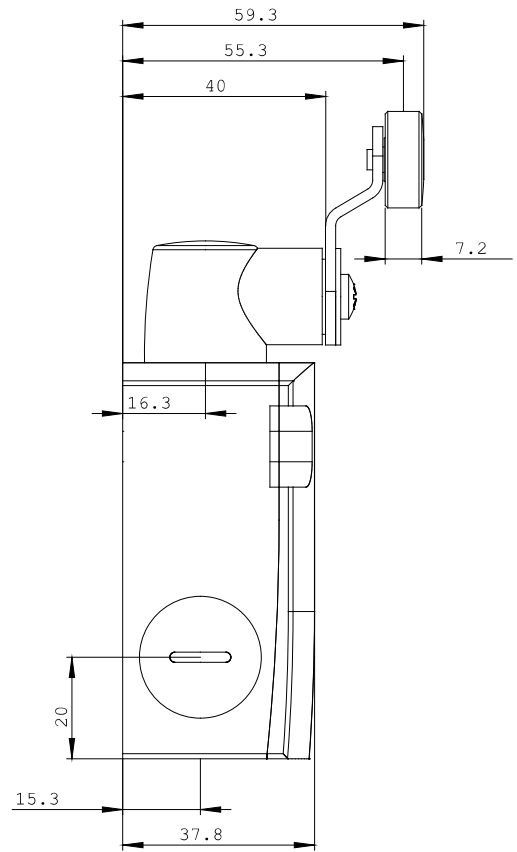
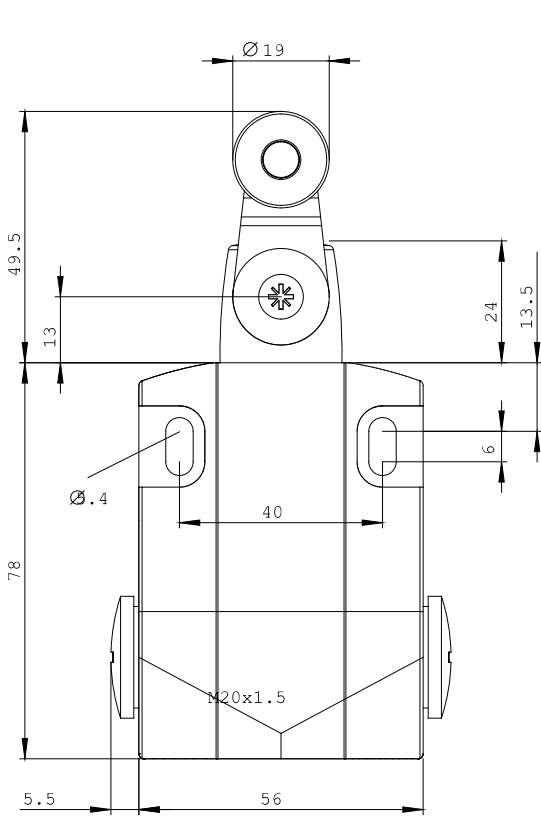

last change:

Oct 2, 2012